

P-channel 100 V, 0.136 Ω typ., 10 A STripFET™ F6 Power MOSFET in a DPAK package

Datasheet - production data

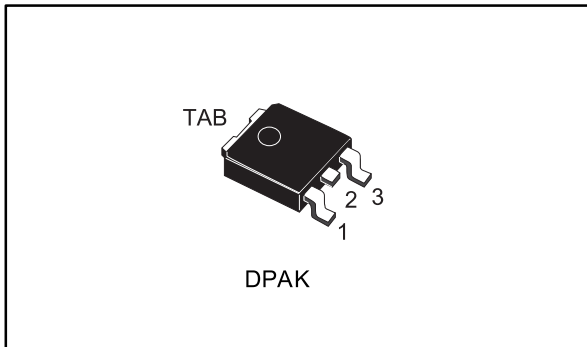
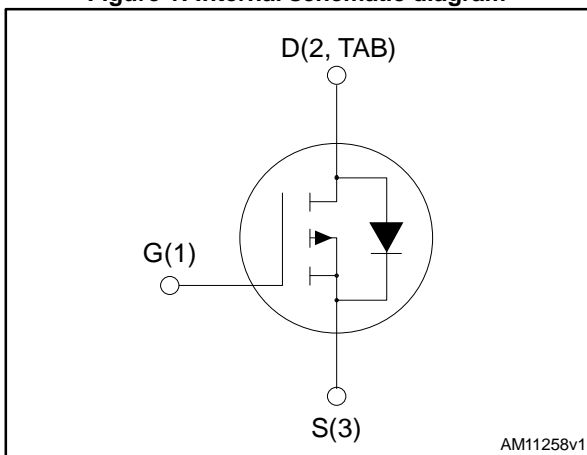

Figure 1: Internal schematic diagram



Features

Order code	V _{DSS}	R _{DS(on)} max	I _D
STD10P10F6	100 V	0.18 Ω	10 A

- Very low on-resistance
- Very low gate charge
- High avalanche ruggedness
- Low gate drive power loss

Applications

- Switching applications

Description

This device is a P-channel Power MOSFET developed using the STripFET™ F6 technology with a new trench gate structure. The resulting Power MOSFET exhibits very low R_{DS(on)} in all packages.

Table 1: Device summary

Order code	Marking	Package	Packaging
STD10P10F6	10P10F6	DPAK	Tape and reel

-  For the P-channel Power MOSFET the actual polarity of the voltages and the current must be reversed.

Contents

1	Electrical ratings	3
2	Electrical characteristics	4
	2.1 Electrical characteristics (curves).....	6
3	Package mechanical data	8
	3.1 DPAK (TO-252) type A mechanical data.....	9
4	DPAK (TO-252) tape and reel mechanical data	12
5	Revision history	14

1 Electrical ratings

Table 2: Absolute maximum ratings

Symbol	Parameter	Value	Unit
V_{DS}	Drain-source voltage	100	V
V_{GS}	Gate-source voltage	± 20	V
I_D	Drain current (continuous) at $T_C = 25\text{ }^\circ\text{C}$	10	A
I_D	Drain current (continuous) at $T_C = 100\text{ }^\circ\text{C}$	7.5	A
$I_{DM}^{(1)}$	Drain current (pulsed)	40	A
P_{TOT}	Total dissipation at $T_C = 25\text{ }^\circ\text{C}$	40	W
T_{stg}	Storage temperature	-55 to 175	$^\circ\text{C}$
T_j	Max. operating junction temperature	175	$^\circ\text{C}$

Notes:

⁽¹⁾Pulse width limited by safe operating area

Table 3: Thermal data

Symbol	Parameter	Value	Unit
$R_{thj-case}$	Thermal resistance junction-case max	3.75	$^\circ\text{C/W}$
$R_{thj-pcb}^{(1)}$	Thermal resistance junction-pcb max	50	$^\circ\text{C/W}$

Notes:

⁽¹⁾When mounted on 1 inch² FR-4, 2 Oz copper board



For the P-channel Power MOSFET the actual polarity of the voltages and the current must be reversed.

2 Electrical characteristics

(T_{CASE} = 25 °C unless otherwise specified).

Table 4: Static

Symbol	Parameter	Test conditions	Min.	Typ.	Max.	Unit
V _{(BR)DSS}	Drain-source breakdown Voltage	V _{GS} = 0, I _D = 250 μA	100			V
I _{DSS}	Zero gate voltage drain current	V _{GS} = 0, V _{DS} = 100 V			1	μA
		V _{GS} = 0, V _{DS} = 100 V, T _C = 125 °C			10	μA
I _{GSS}	Gate body leakage current	V _{DS} = 0, V _{GS} = ± 20 V			±100	nA
V _{GS(th)}	Gate threshold voltage	V _{DS} = V _{GS} , I _D = 250 μA	2		4	V
R _{DS(on)}	Static drain-source on-resistance	V _{GS} = 10 V, I _D = 5 A		0.136	0.18	Ω

Table 5: Dynamic

Symbol	Parameter	Test conditions	Min.	Typ.	Max.	Unit
C _{iss}	Input capacitance	V _{DS} = 80 V, f = 1 MHz, V _{GS} = 0	-	864	-	pF
C _{oss}	Output capacitance		-	45	-	pF
C _{rss}	Reverse transfer capacitance		-	25	-	pF
Q _g	Total gate charge	V _{DD} = 80 V, I _D = 10 A V _{GS} = 10 V	-	16.5	-	nC
Q _{gs}	Gate-source charge		-	3.5	-	nC
Q _{gd}	Gate-drain charge		-	3.8	-	nC

Table 6: Switching on/off (inductive load)

Symbol	Parameter	Test conditions	Min.	Typ.	Max.	Unit
t _{d(on)}	Turn-on delay time	V _{DD} = 80 V, I _D = 5 A, R _G = 4.7 Ω, V _{GS} = 10 V	-	10.5	-	ns
t _r	Rise time		-	4.8	-	ns
t _{d(off)}	Turn-off delay time		-	24	-	ns
t _f	Fall time		-	4.5	-	ns



For the P-channel Power MOSFET the actual polarity of the voltages and the current must be reversed.

Table 7: Source drain diode

Symbol	Parameter	Test conditions	Min.	Typ.	Max.	Unit
$V_{SD}^{(1)}$	Forward on voltage	$I_{SD} = 5 \text{ A}$, $V_{GS} = 0$	-		1.1	V
t_{rr}	Reverse recovery time	$I_{SD} = 10 \text{ A}$, $di/dt = 100 \text{ A}/\mu\text{s}$, $V_{DD} = 80 \text{ V}$	-	26.5		ns
Q_{rr}	Reverse recovery charge		-	36.5		nC
I_{RRM}	Reverse recovery current		-	2.7		A

Notes:

⁽¹⁾Pulsed: pulse duration = 300 μs , duty cycle 1.5%



For the P-channel Power MOSFET the actual polarity of the voltages and the current must be reversed.

2.1 Electrical characteristics (curves)

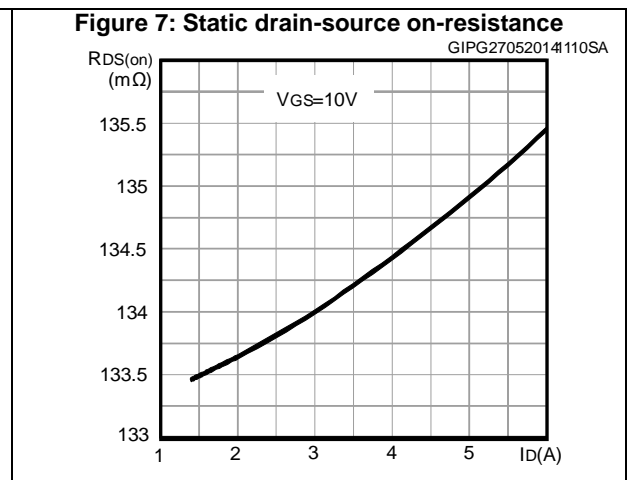
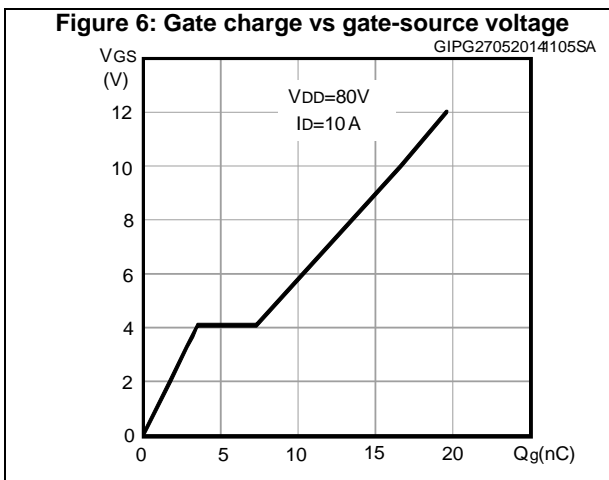
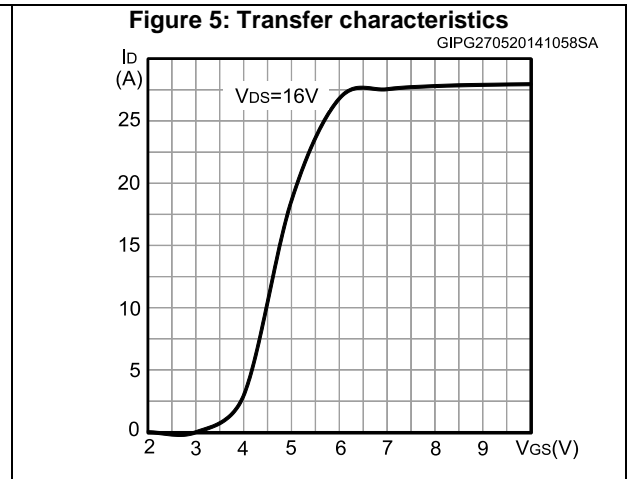
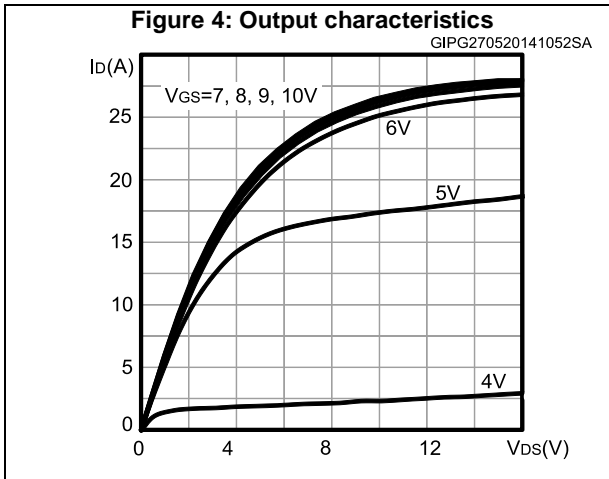
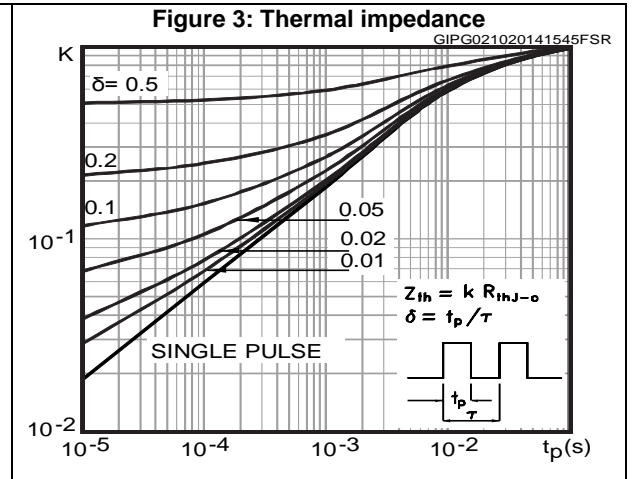
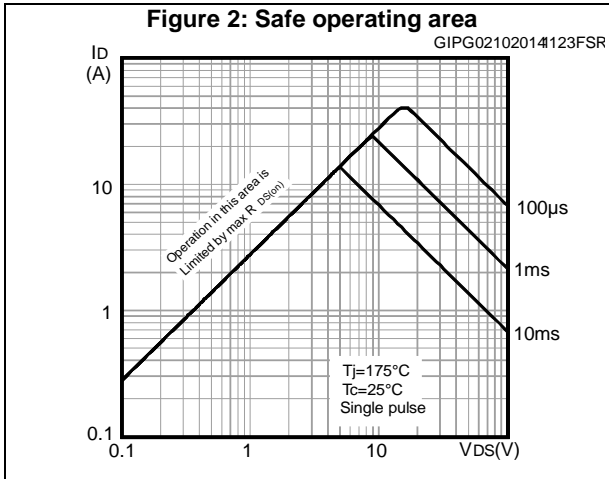

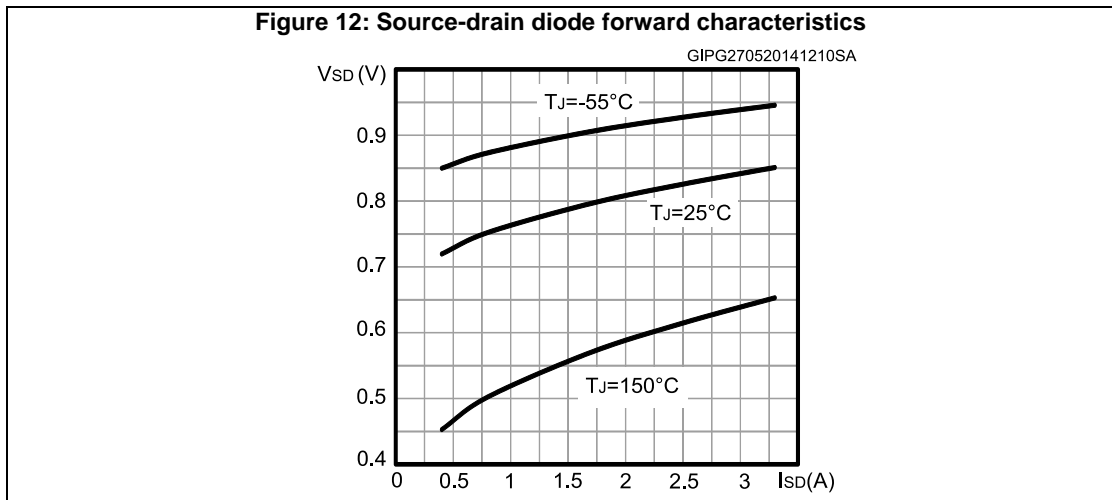
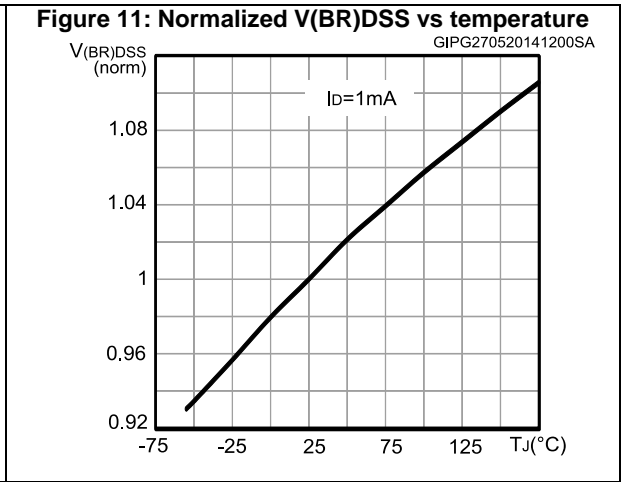
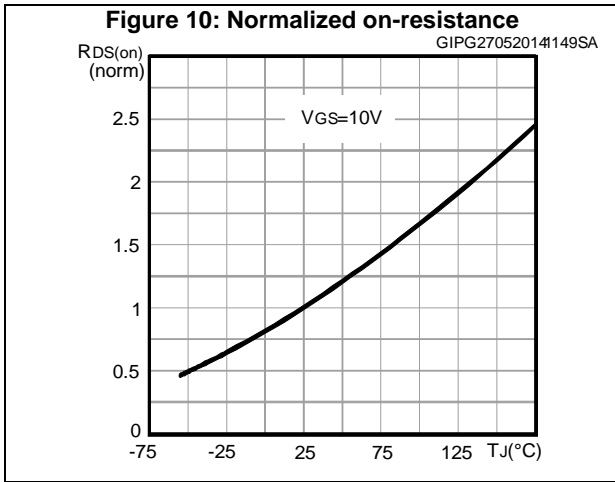
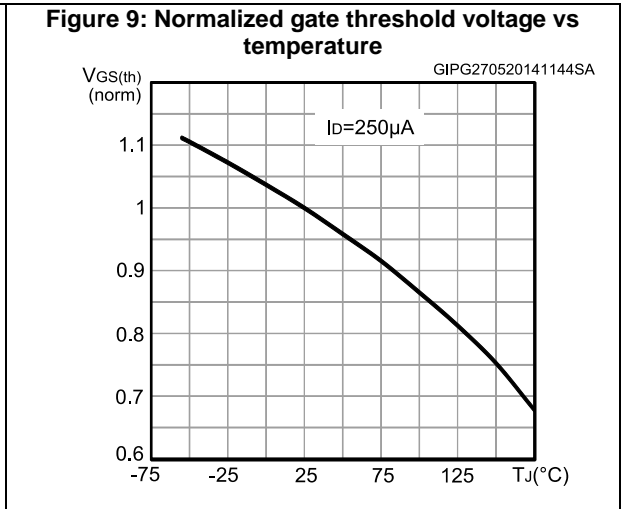
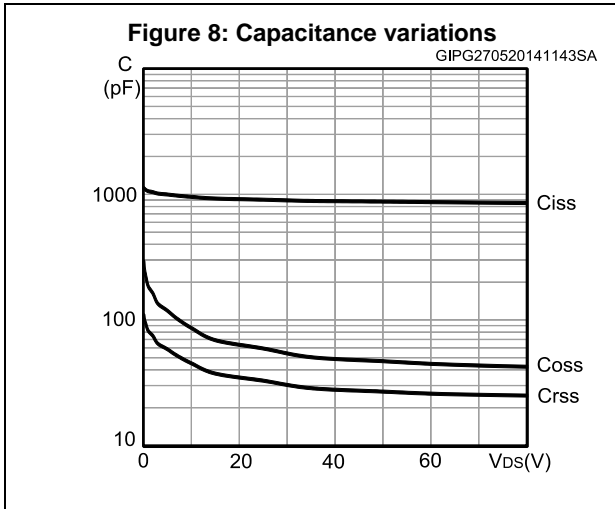

3 Package mechanical data

In order to meet environmental requirements, ST offers these devices in different grades of ECOPACK® packages, depending on their level of environmental compliance. ECOPACK® specifications, grade definitions and product status are available at: www.st.com. ECOPACK® is an ST trademark.

3.1 DPAK (TO-252) type A mechanical data

Figure 13: DPAK (TO-252) type A drawings

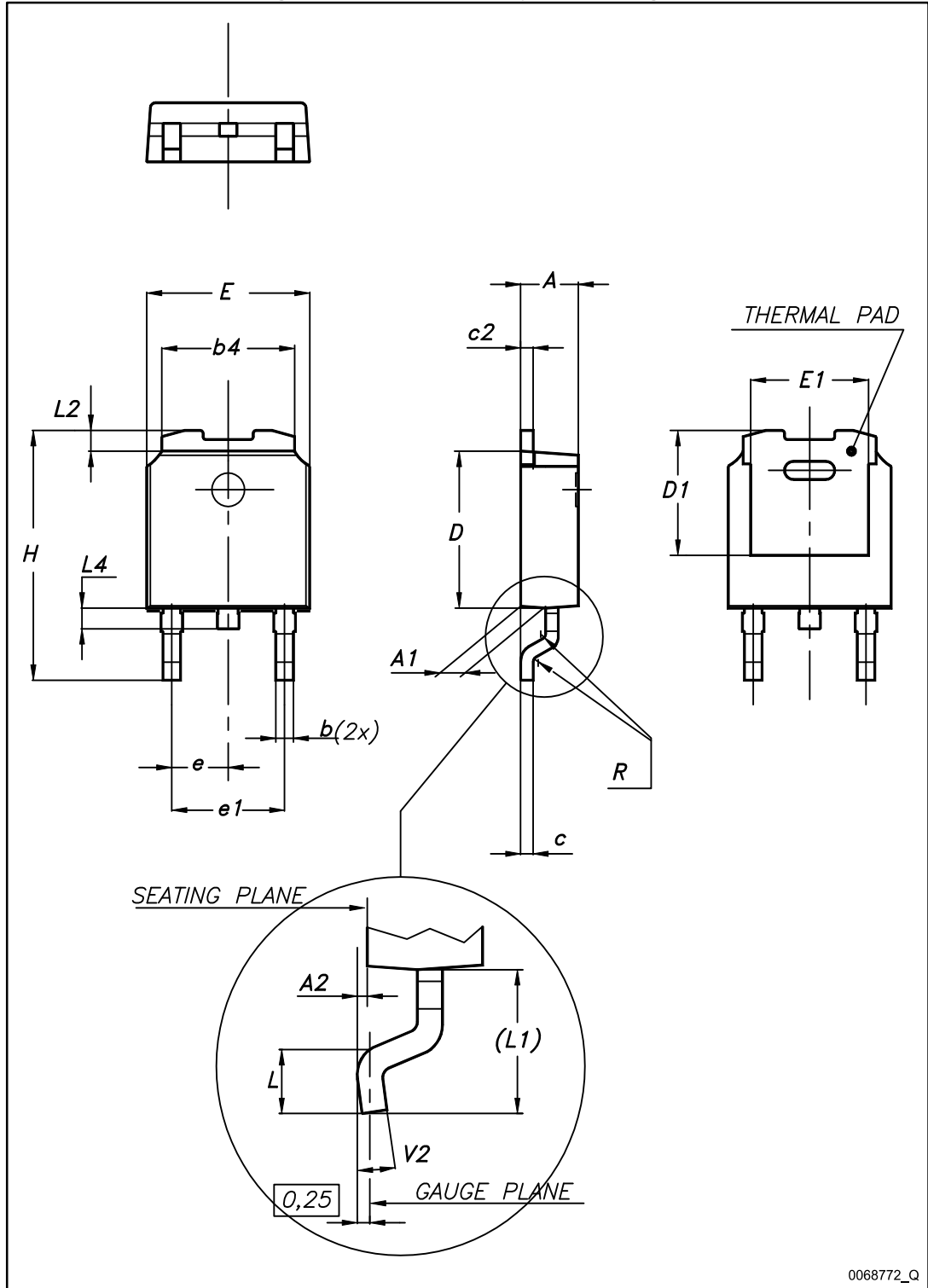
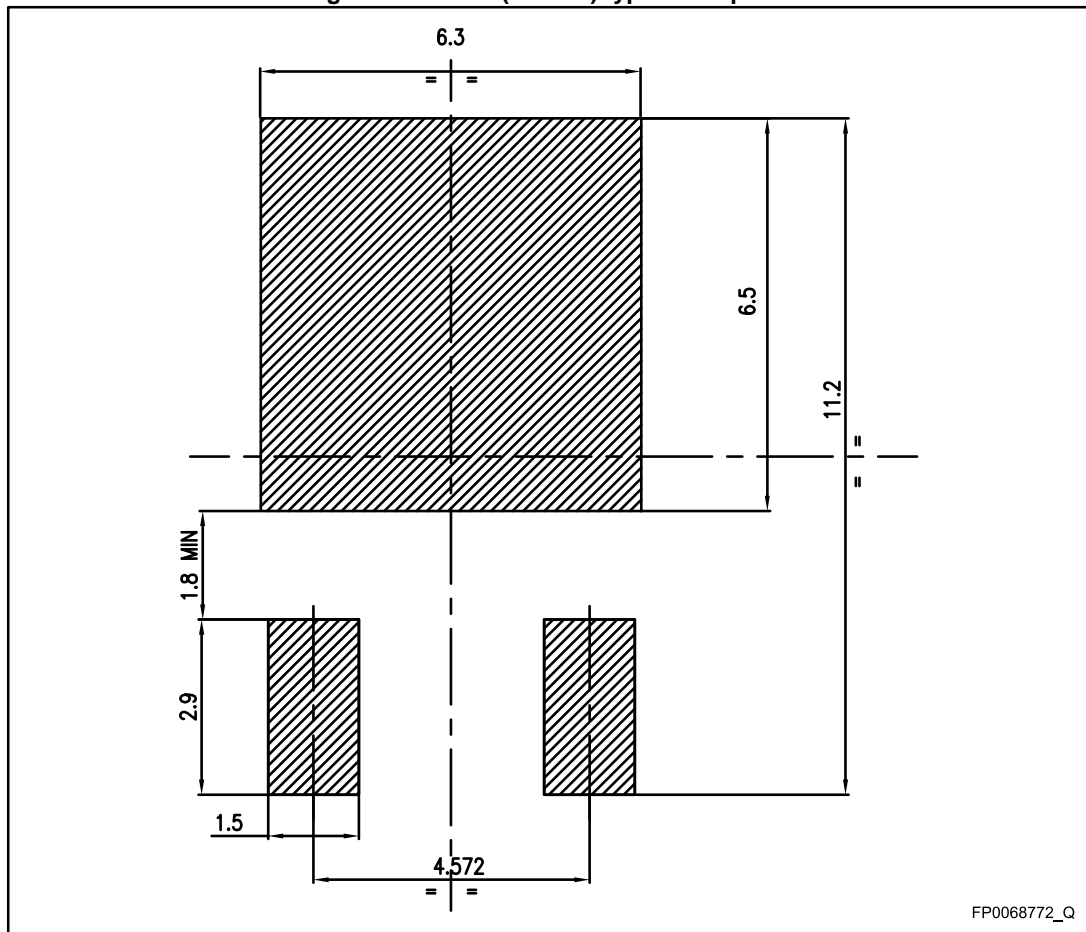

Table 8: DPAK (TO-252) type A mechanical data

Dim.	mm		
	Min.	Typ.	Max.
A	2.20		2.40
A1	0.90		1.10
A2	0.03		0.23
b	0.64		0.90
b4	5.20		5.40
c	0.45		0.60
c2	0.48		0.60
D	6.00		6.20
D1		5.10	
E	6.40		6.60
E1		4.70	
e		2.28	
e1	4.40		4.60
H	9.35		10.10
L	1.00		1.50
(L1)		2.80	
L2		0.80	
L4	0.60		1.00
R		0.20	
V2	0°		8°

Figure 14: DPAK (TO-252) type A footprint



All dimensions are in mm

4 DPAK (TO-252) tape and reel mechanical data

Figure 15: Tape for DPAK (TO-252)

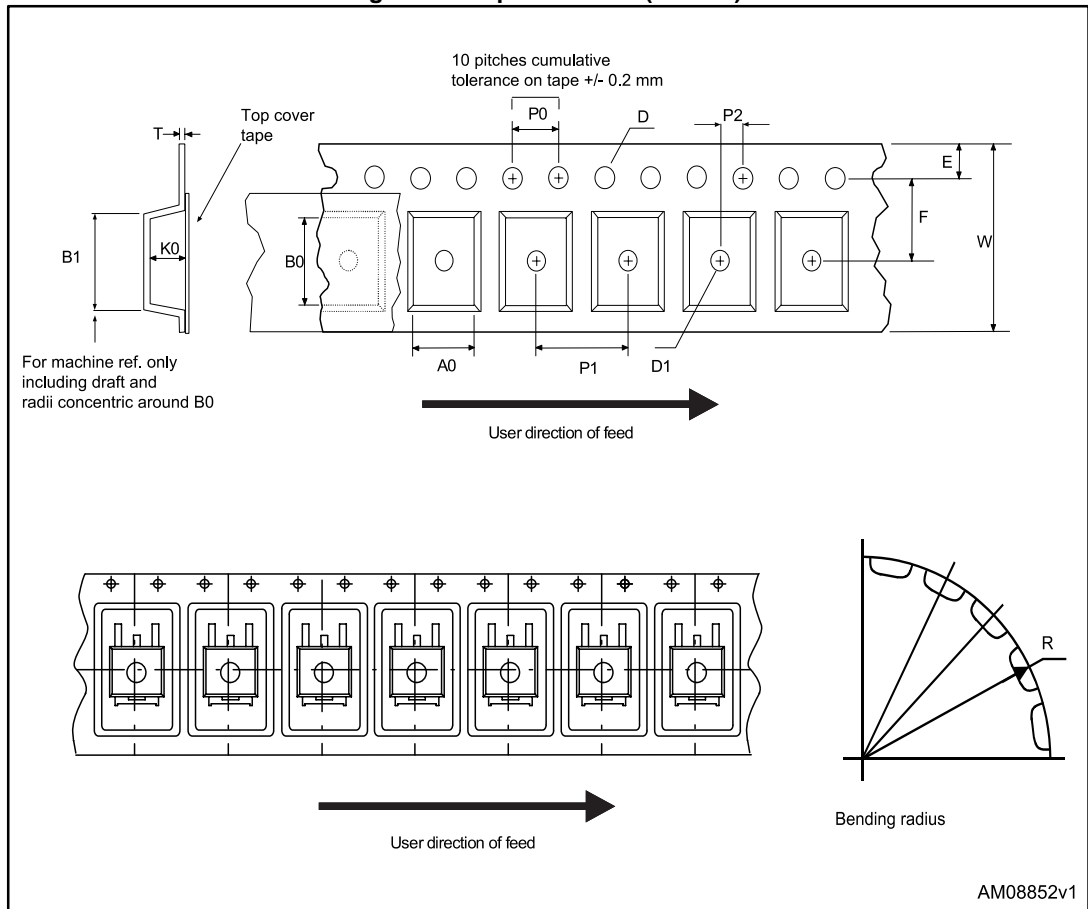

Figure 16: Reel for DPAK (TO-252)

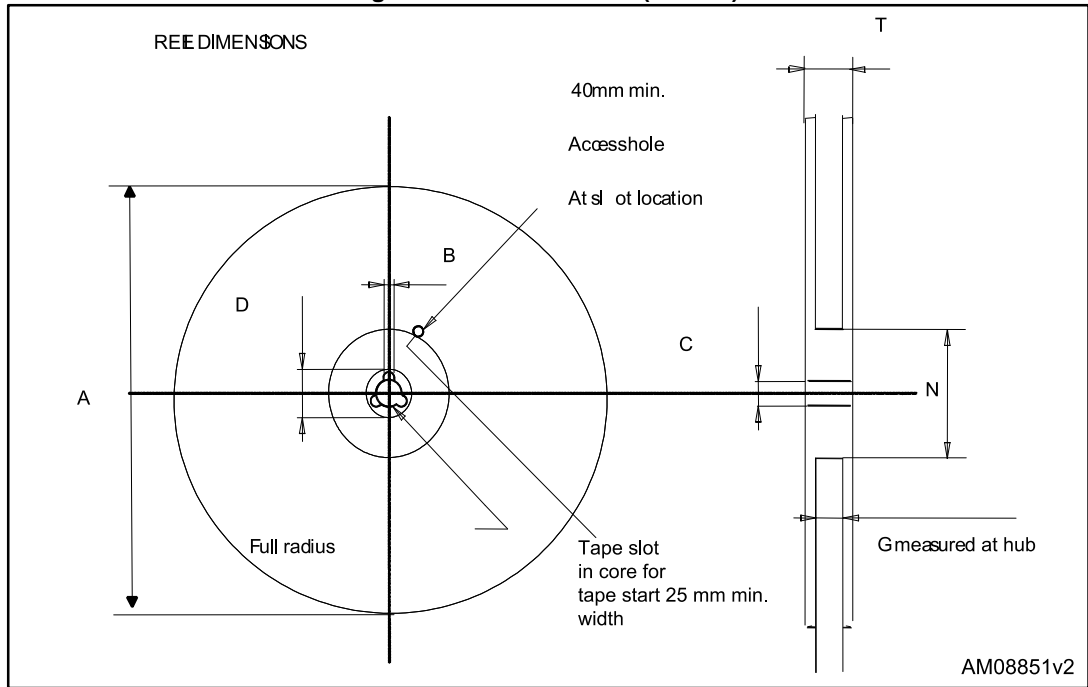

Table 9: DPAK (TO-252) tape and reel mechanical data

Tape			Reel		
Dim.	mm		Dim.	mm	
	Min.	Max.		Min.	Max.
A0	6.8	7	A		330
B0	10.4	10.6	B	1.5	
B1		12.1	C	12.8	13.2
D	1.5	1.6	D	20.2	
D1	1.5		G	16.4	18.4
E	1.65	1.85	N	50	
F	7.4	7.6	T		22.4
K0	2.55	2.75			
P0	3.9	4.1	Base qty.		2500
P1	7.9	8.1	Bulk qty.		2500
P2	1.9	2.1			
R	40				
T	0.25	0.35			
W	15.7	16.3			

5 Revision history

Table 10: Document revision history

Date	Revision	Changes
20-May-2014	1	First release.
02-Oct-2014	2	Document status promoted from preliminary to production data Added Section 2.1: "Electrical characteristics (curves)" .

IMPORTANT NOTICE – PLEASE READ CAREFULLY

STMicroelectronics NV and its subsidiaries ("ST") reserve the right to make changes, corrections, enhancements, modifications, and improvements to ST products and/or to this document at any time without notice. Purchasers should obtain the latest relevant information on ST products before placing orders. ST products are sold pursuant to ST's terms and conditions of sale in place at the time of order acknowledgement.

Purchasers are solely responsible for the choice, selection, and use of ST products and ST assumes no liability for application assistance or the design of Purchasers' products.

No license, express or implied, to any intellectual property right is granted by ST herein.

Resale of ST products with provisions different from the information set forth herein shall void any warranty granted by ST for such product.

ST and the ST logo are trademarks of ST. All other product or service names are the property of their respective owners.

Information in this document supersedes and replaces information previously supplied in any prior versions of this document.

© 2014 STMicroelectronics – All rights reserved