

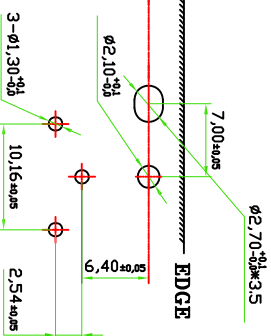

Product NO.		DOSIN-801-0212		
REV	DESCRIPTION	DWN	DATE	APPROVEN
A	First Issue	JIM	2012/11/02	John kine

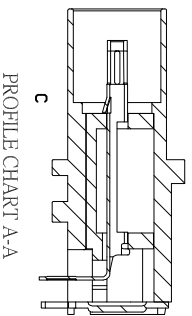
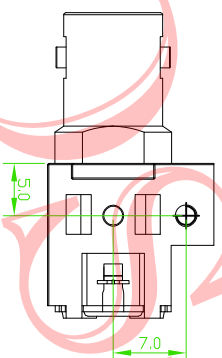
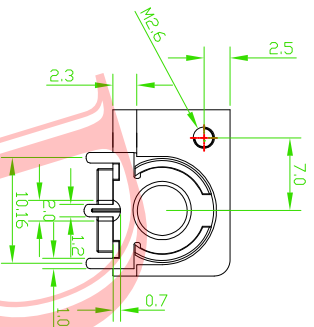
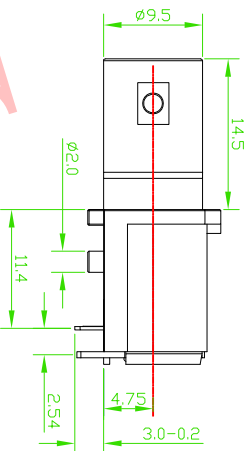
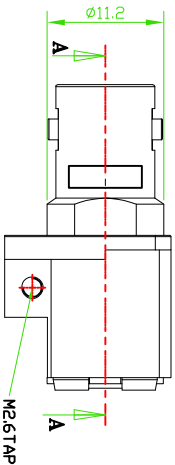
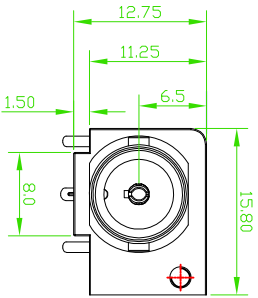

Specifications

Impedance: 75 Ohms
 Frequency Range: DC~3G
 VSWR: 1.3MAX
 Working Voltage: 500V rms @ sea Level
 Insulation Resistance: 5000 Ohms min
 Temperature Range: -55°C T0 +155°C
 Relative Temperature: $\leq 95\%$ (40° C $\pm 2^\circ$ C)
 Drawings products are in line with ROHS standards

NOTE:

DRAWN	2012/11/10	Tolerance	0-6 6-30 30-120 Angular	± 0.10 ± 0.20 ± 0.40 $\pm 2^\circ$
CHECKED		View		
APPROVALS		UNIT	MM	
John Kine	12/04.2012	SCALE	1:1	

Name:	BNC CONNECTOR		
SIZE	Product NO.	CAD FILE	REV
A	DOSIN-801-0212	D/company drawings/BD	A

DOSIN CONNECTION
Dosin Industrial(H.K)Co.Ltd
 东莞市德索五金电子有限公司
Dosin Hardware Electronics Co.,Ltd
 E-mail:dosin2005@163.com
 dosin2005@dosing-china.com
 Web: http://www.dosing.com
 TEL:(0086)769-81153906
 FAX:(0086)769-81875836

4	Cover	BRASS	TIN	1
3	BODY	ZINC	NICKE	1
2	PIN	Brass	GOLD	1
1	Insulator	PBT	White	1
NO	DESCRIPTION	MATERIAL	FINISH	QTY

A	B	C	D	E	F	G
---	---	---	---	---	---	---