

Features

- Low operating voltage: $\pm 24V$
- Ultra low capacitance: 0.3pF typical
- Ultra low leakage: nA level
- Low operating voltage:
- Low clamping voltage
- 2-pin leadless package
- Complies with following standards:
 - – IEC 61000-4-2 (ESD) immunity test
 - Air discharge: $\pm 20kV$
 - Contact discharge: $\pm 15kV$
 - – IEC61000-4-5 (Lightning) 2A (8/20 μs)
- RoHS Compliant
- Lead Finish: NiPdAu

Mechanical Characteristics

- Package: DFN1006-2(0402)
- Lead Finish: Matte Tin
- Case Material: "Green" Molding Compound.
- Moisture Sensitivity: Level 3 per J-STD-020
- Terminal Connections: See Diagram Below
- Shipping Qty :15000pcs Or 10000/7Inch Tape & Reel

Applications

- VGA, DVI, SDI, USB1.0, USB2.0, USB3.0, USB3.1
- High Definition Multi-Media Interface(HDMI1.3/1.4/2.0)
- Serial and Parallel Ports
- Notebooks, Desktops, Servers
- Peripherals

Dimensions and Pin Configuration

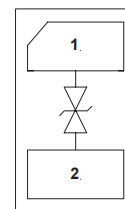
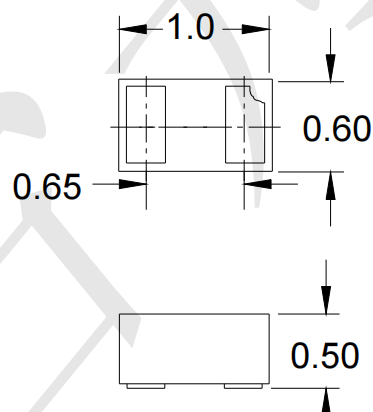

Marking: CR

Absolute Maximum Ratings (Tamb=25°C unless otherwise specified)

Parameter	Symbol	Value	Unit
Peak Pulse Power (8/20μs)	Ppk	90	W
Peak Pulse Current (8/20μs)	Ipp	2	A
ESD per IEC 61000-4-2 (Air)	VESD	±20	kV
ESD per IEC 61000-4-2 (Contact)		±15	
Operating Temperature Range	TJ	-55 to +125	°C
Storage Temperature Range	Tstg	-55 to +150	°C

Electrical Characteristics (TA=25°C unless otherwise specified)

Parameter	Symbol	Min	Typ	Max	Unit	Test Condition
Reverse Working Voltage	VRWM			24	V	
Breakdown Voltage	VBR	26.4			V	IT = 1mA
Reverse Leakage Current	IR			0.1	μA	VRWM = 24V
Clamping Voltage	VC			40	V	Ipp=1A(8x 20us pulse)
Clamping Voltage	VC			55	V	Ipp=2A(8x 20us pulse)
Junction Capacitance	CJ		0.3		pF	VR = 0V, f = 1MHz

Typical Performance Characteristics ($T_A=25^\circ\text{C}$ unless otherwise Specified)

Fig1. 8/20 μs Pulse Waveform

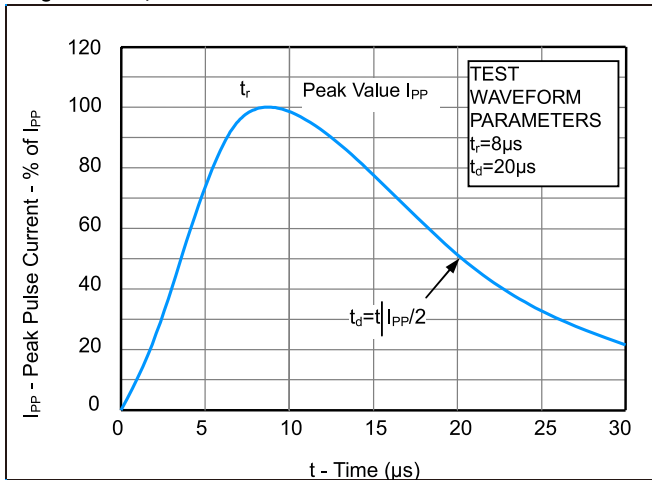

Fig2. ESD Pulse Waveform (according to IEC 61000-4-2)

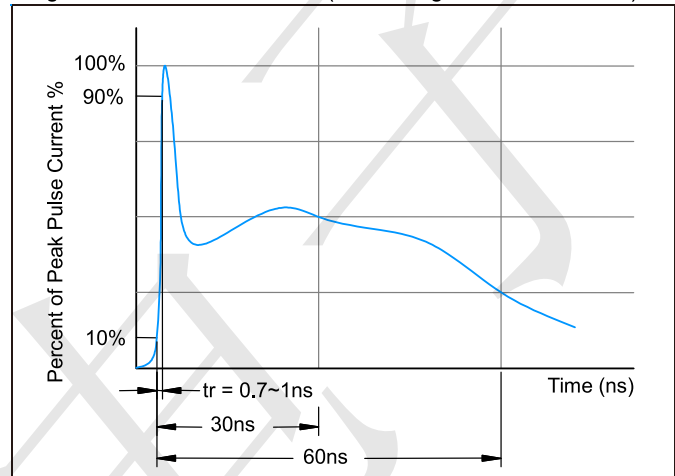
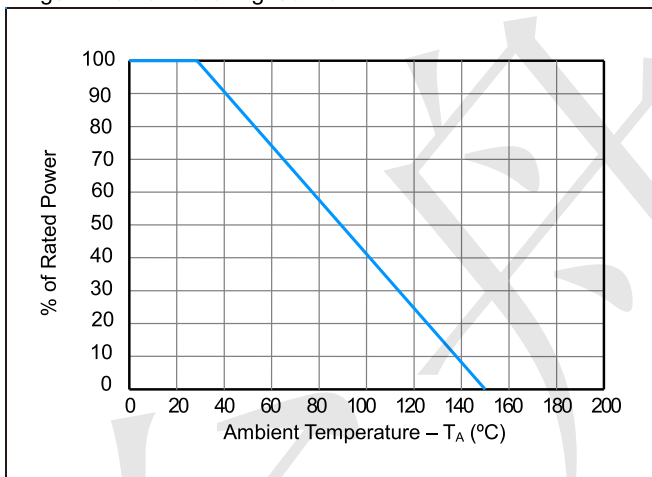
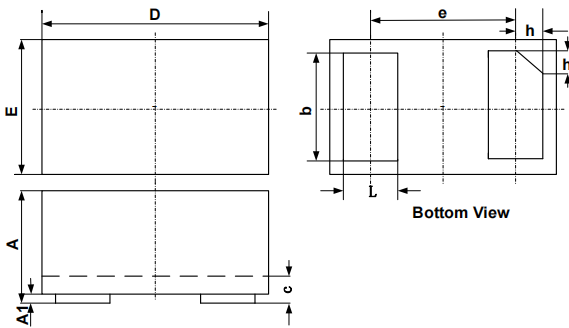

Fig3. Power Derating Curve





DFN1006-2 Package Outline Drawing (0402)



SYM	DIMENSIONS					
	MILLIMETERS			INCHES		
	MIN	NOM	MAX	MIN	NOM	MAX
A	0.45	0.50	0.55	0.018	0.020	0.022
A1	0.00	0.02	0.05	0.000	0.001	0.002
b	0.45	0.50	0.55	0.018	0.020	0.022
c	0.12	0.15	0.18	0.005	0.006	0.007
D	0.95	1.00	1.05	0.037	0.039	0.041
e	0.65 BSC			0.026 BSC		
E	0.55	0.60	0.65	0.022	0.024	0.026
L	0.20	0.25	0.30	0.008	0.010	0.012
h	0.07	0.12	0.17	0.003	0.005	0.007

Suggested Land Pattern

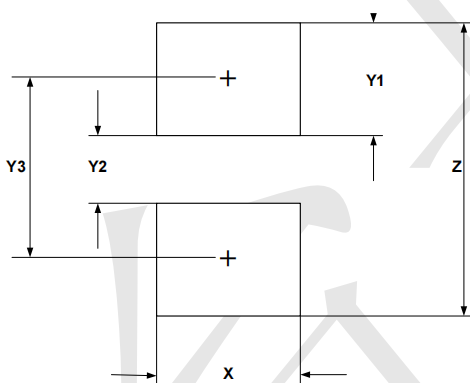

SYM	DIMENSIONS	
	MILLIMETERS	INCHES
X	0.60	0.024
Y1	0.50	0.020
Y2	0.30	0.012
Y3	0.80	0.032
Z	1.30	0.052