

Description

The 15KP series of high current uni/bi-directional transient suppressors are designed for A.C. line protection and high power DC bus clamping applications. These devices offer uni/bi-directional port protection from 5.0 volts to 250 volts. They provide a clamping voltage lower than the avalanche voltage. Therefore, any voltage rise due to increased current conduction is contained to a minimum, providing the best possible protection level. They can also be connected in series and/or parallel to create very high capacity protection solutions.

Features

- Excellent clamping capability.
- Repetition rate (duty cycle): 0.01%.
- Color band denoted cathode except bidirectional.
- 15000W Peak Pulse power capability at 10×1000µs waveform.
- Fast response time: typically less than 1.0ps from 0V to V_{BR} min.
- High temperature soldering: 260°C/10s at terminals.

Dimensions& Symbol (Unit: mm Max)

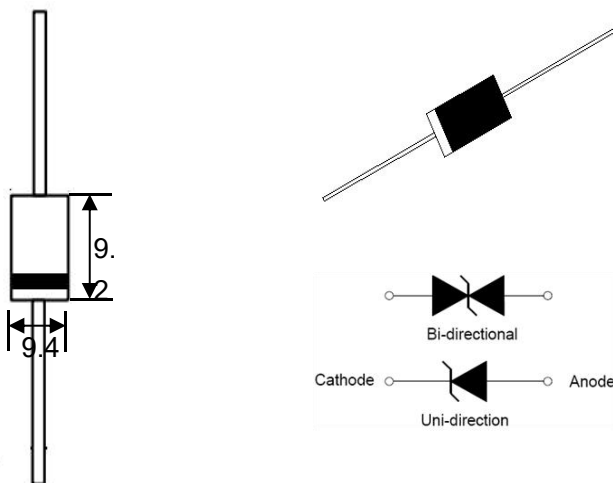

Mechanical Characteristics

Package: P600

- UL Flammability Classification Rating94V-0
- Polarity: Color band denotes cathode except bi-directional models
- Standard Packaging: BOX
- Weight: 1.2g
- Terminal Connections: See DiagramBelow
- Marking Information: SeeBelow

Applications

- I/O Interface.
- AC/DC Power supply
- Other vulnerable circuits used in Telecom, Computer, Industrial and Consumer electronic applications

Marking Information

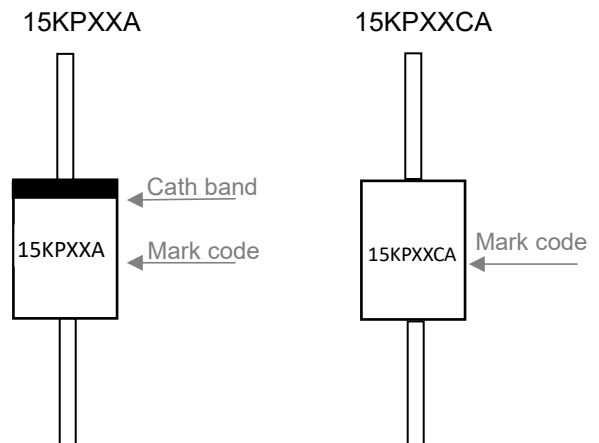

Ordering Information

Out line	Reel (pcs)	Per carton (pcs)	Packing Option
Taping	300	3K	Box

Electrical Characteristics (T_A=25°C)

Part Number		V _R	I _R @V _R	V _{BR} @I _T		I _T	V _C @I _{PP}	I _{PP} ^①
Uni-Polar	Bi-Polar	V	μA	min(V)	max(V)	mA	max(V)	A
15KP17A	15KP17CA	17.0	5000	18.90	20.90	5	29.3	515.4
15KP18A	15KP18CA	18.0	5000	20.00	22.10	5	30.9	488.7
15KP20A	15KP20CA	20.0	1500	22.20	24.50	5	34.3	440.2
15KP22A	15KP22CA	22.0	500	24.40	26.90	5	37.1	407.0
15KP24A	15KP24CA	24.0	150	26.70	29.50	5	40.7	371.0
15KP26A	15KP26CA	26.0	50	28.90	31.90	5	44.0	343.2
15KP28A	15KP28CA	28.0	25	31.10	34.40	5	47.5	317.9
15KP30A	15KP30CA	30.0	15	33.30	36.80	5	50.7	297.8
15KP33A	15KP33CA	33.0	2	36.70	40.60	5	54.7	276.1
15KP36A	15KP36CA	36.0	2	40.00	44.20	5	59.8	252.5
15KP40A	15KP40CA	40.0	2	44.40	49.10	5	65.8	229.5
15KP43A	15KP43CA	43.0	2	47.80	52.80	5	69.8	216.3
15KP45A	15KP45CA	45.0	2	50.00	55.30	5	72.8	207.4
15KP48A	15KP48CA	48.0	2	53.30	58.90	5	77.7	194.3
15KP51A	15KP51CA	51.0	2	56.70	62.70	5	82.9	182.1
15KP54A	15KP54CA	54.0	2	60.00	66.30	5	87.7	172.2
15KP58A	15KP58CA	58.0	2	64.40	71.20	5	93.8	161.0
15KP60A	15KP60CA	60.0	2	66.70	73.70	5	97.4	155.0
15KP64A	15KP64CA	64.0	2	71.10	78.60	5	104.2	144.9
15KP70A	15KP70CA	70.0	2	77.80	86.00	5	113.6	132.9
15KP75A	15KP75CA	75.0	2	83.30	92.10	5	122.0	123.8
15KP78A	15KP78CA	78.0	2	86.70	95.80	5	126.1	119.7
15KP85A	15KP85CA	85.0	2	94.40	104.0	5	137.6	109.7
15KP90A	15KP90CA	90.0	2	100.0	111.0	5	145.6	103.7
15KP100A	15KP100CA	100.0	2	111.0	123.0	5	161.3	93.6
15KP110A	15KP110CA	110.0	2	122.0	135.0	5	178.6	84.5
15KP120A	15KP120CA	120.0	2	133.0	147.0	5	192.3	78.5
15KP130A	15KP130CA	130.0	2	144.0	159.0	5	208.3	72.5
15KP150A	15KP150CA	150.0	2	167.0	185.0	5	241.9	62.4

Electrical Characteristics (T_A=25°C, continued)

Part Number		V _R	I _{R@V_R}	V _{BR@I_T}		I _T	V _{C@I_{PP}}	I _{PP} ^①
Uni-Polar	Bi-Polar	V	μA	min(V)	max(V)	mA	max(V)	A
15KP160A	15KP160CA	160.0	2	178.0	197.0	5	258.6	58.4
15KP170A	15KP170CA	170.0	2	189.0	209.0	5	272.7	55.4
15KP180A	15KP180CA	180.0	2	201.0	222.0	5	288.5	52.3
15KP200A	15KP200CA	200.0	2	224.0	247.0	5	319.1	47.3
15KP220A	15KP220CA	220.0	2	246.0	272.0	5	352.5	42.8
15KP240A	15KP240CA	240.0	2	268.0	292.0	5	384.6	39.3
15KP260A	15KP260CA	260.0	2	289.0	317.0	5	416.7	36.2
15KP280A	15KP280CA	280.0	2	311.0	341.0	5	454.5	33.2

① Surge waveform: 10/1000μs

V_R: Stand-off Voltage -- Maximum voltage that can be applied

V_{BR}: Breakdown Voltage

V_C: Clamping Voltage -- Peak voltage measured across the suppressor at a specified I_{pp}

I_R: Reverse Leakage Current

Part Number Code

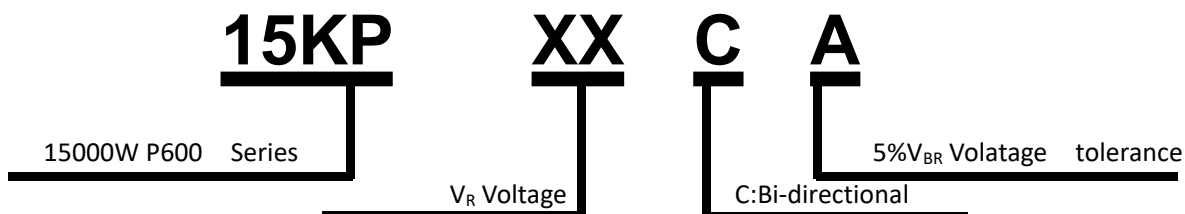

Absolute Maximum Ratings ($T_A=25^{\circ}\text{C}$, $\text{RH}=45\%-75\%$, unless otherwise noted)

Parameter	Symbol	Value	Unit
Peak pulse power dissipation on 10/1000 μs waveform	P_{PP}	15000	W
Peak pulse current of on 10/1000 μs waveform	I_{PP}	See last table	A
Steady state power dissipation at $T_L=75^{\circ}\text{C}$	$P_{M(AV)}$	8	W
Operating junction and Storage temperature range	T_{STG}, T_J	-55 to +150	$^{\circ}\text{C}$
Peak forward surge current, 8.3ms single half sine-wave	I_{FSM}	400	A

Ratings And V-I Characteristics Curves ($T_A=25^{\circ}\text{C}$, unless otherwise noted)

FIG.1:V- I curve characteristics (Uni-directional)

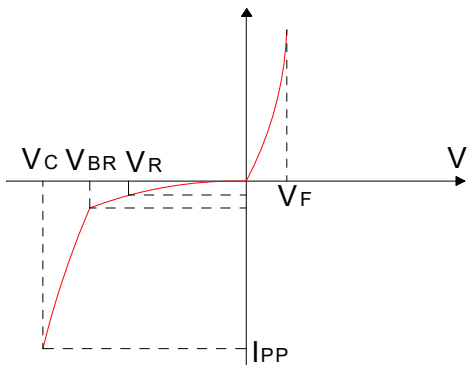

FIG.2:V- I curve characteristics (Bi-directional)

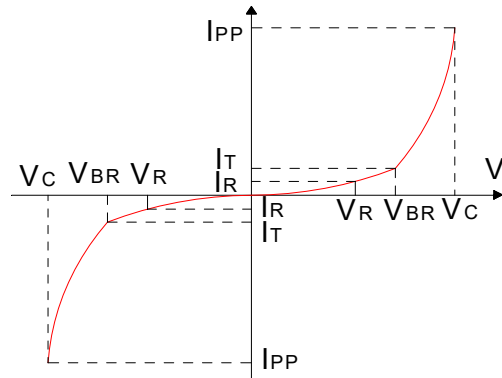

FIG.3: Pulse waveform

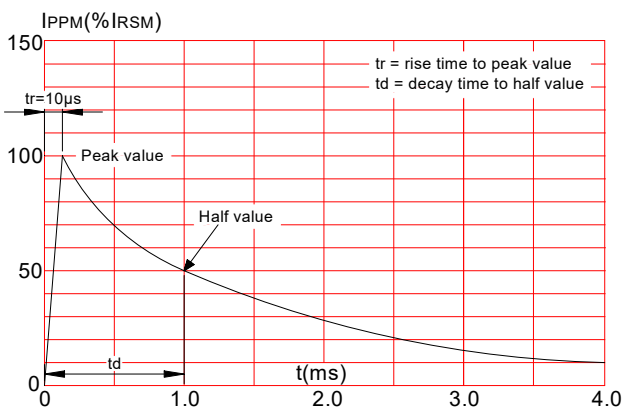
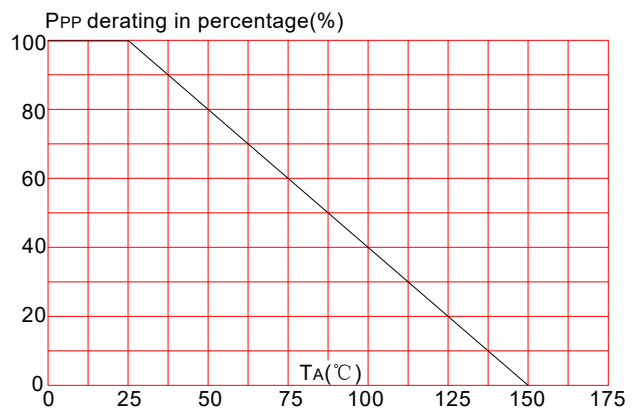
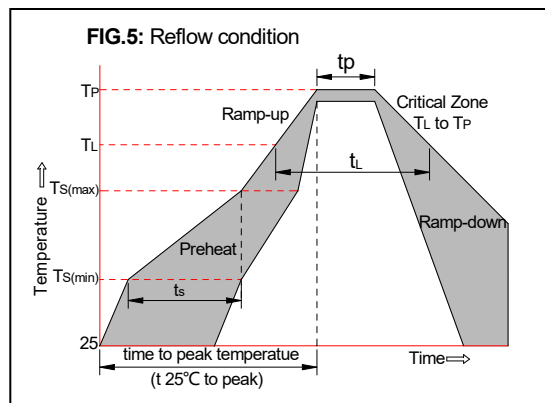

FIG.4: Pulse derating curve



Soldering Parameters

Reflow Condition		Pb-Free assembly (see FIG.5)
Pre Heat	-Temperature Min ($T_{s(min)}$)	+150°C
	-Temperature Max($T_{s(max)}$)	+200°C
	-Time (Min to Max) (t_s)	60-180 secs.
Average ramp up rate (Liquid us Temp (T_L)to peak)		3°C/sec. Max
$T_{s(max)}$ to T_L - Ramp-up Rate		3°C/sec. Max
Reflow	-Temperature(T_L)(Liquid us)	+217°C
	-Temperature(t_L)	60-150 secs.
Peak Temp (T_p)		+260(+0/-5)°C
Time within 5°C of actual Peak Temp (t_p)		30 secs. Max
Ramp-down Rate		6°C/sec. Max
Time 25°C to Peak Temp (T_P)		8 min. Max
Do not exceed		+260°C



Package Mechanical Data

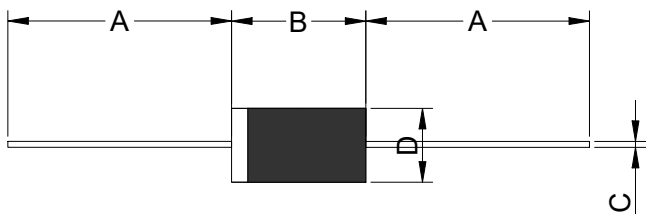

Ref.	Dimensions			
	Inches		Millimeters	
	Min.	Max.	Min.	Max.
A	1.000	-	25.40	-
B	0.339	0.370	8.60	9.40
C	0.048	0.052	1.20	1.40
D	0.340	0.360	8.60	9.10

Tape & Reel Specification – P600

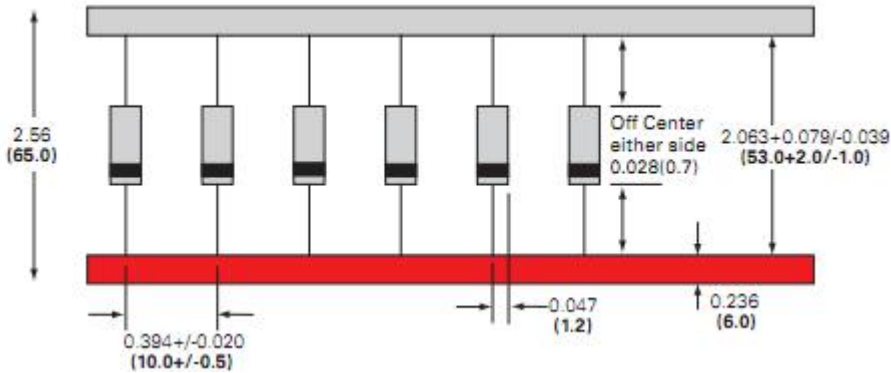

Contact Information

WPMTEK Incorporated Limited

Floor 1 Building 4#, Binxianghua Industry Park, No.7,

Huada Road, Hualian Community, Longhua New District, Shenzhen

TEL: 86755-29308003 FAX: 86755-23739900

wpmtek Incorporated Limited (WPM) reserves the right to make changes to the product specification and data in this document without notice. WPM makes no warranty, representation or guarantee regarding the suitability of its products for any particular purpose, nor does WPM assume any liability arising from the application or use of any products or circuits, and specifically dis-claims any and all liability, including without limitation special, consequential or incidental damages.