

## Features

- ◆ Ultra low leakage: nA level
- ◆ Low operating voltage: 5V
- ◆ Low clamping voltage
- ◆ Complies with following standards:
  - IEC 61000-4-2 (ESD) immunity test
    - Air discharge:  $\pm 30\text{kV}$
    - Contact discharge:  $\pm 30\text{kV}$
  - IEC61000-4-4 (EFT) 40A (5/50ns)
- ◆ ROHS Compliant
- ◆ Lead Finish: NiPdAu

## Mechanical Characteristics

- ◆ Package: SOT23-6
- ◆ Lead Finish: Matte Tin
- ◆ Case Material: “Green” Molding Compound.
- ◆ UL Flammability Classification Rating 94V-0
- ◆ Moisture Sensitivity: Level 3 per J-STD-020
- ◆ Shipping Qty :3000pcs/7Inch Tape & Reel

## Applications

- ◆ Cell phone Handsets and Accessories
- ◆ Microprocessor Based Equipment
- ◆ Personal Digital Assistants (PDA's) and Pagers
- ◆ Desktops PC and Servers
- ◆ Notebook, Laptop, and Palmtop Computers
- ◆ Portable Instrumentation
- ◆ Peripherals

## Dimensions and Pin Configuration

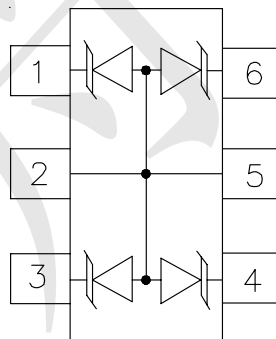

**Marking:  $\nabla$  5G4 Or K5**

**Absolute Maximum Ratings** (Tamb=25°C unless otherwise specified)

Parameter	Symbol	Value	Unit
Peak Pulse Power (8/20μs) (Vcc-GND)	P <sub>pk</sub>	150	W
ESD per IEC61000-4-2 (Air)	V <sub>ESD</sub>	±30	kV
ESD per IEC61000-4-2 (Contact)		±30	
Operating Temperature Range	T <sub>J</sub>	-55 to +125	°C
Storage Temperature Range	T <sub>stg</sub>	-55 to +150	°C

**Electrical Characteristics** (TA=25°C unless otherwise specified)

Parameter	Symbol	Min	Typ	Max	Unit	Test Condition
Reverse Working Voltage	V <sub>RWM</sub>			5	V	
Breakdown Voltage	V <sub>BR</sub>	6		9	V	I <sub>T</sub> =1mA
Leakage Current	I <sub>Leak</sub>			100	nA	V <sub>RWM</sub> =5V
Clamping Voltage	V <sub>C</sub>			11	V	I <sub>PP</sub> =4.5A, T <sub>p</sub> =8/20μs
Clamping Voltage	V <sub>C</sub>			14	V	I <sub>PP</sub> =10A, T <sub>p</sub> =8/20μs
Junction Capacitance (I/O to GND)	C <sub>J</sub>		60	90	pF	V <sub>R</sub> =0V, f=1MHz,
Junction Capacitance (I/O to I/O)	C <sub>J</sub>		30		pF	V <sub>R</sub> =0V, f=1MHz,

**Typical Performance Characteristics ( $T_A=25^\circ\text{C}$  unless otherwise Specified)**

**Fig1. 8/20 $\mu\text{s}$  Pulse Waveform**

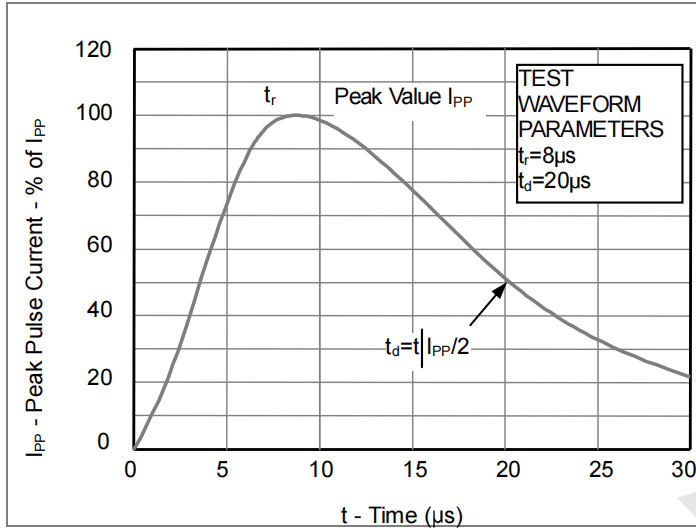

**Fig2. ESD Pulse Waveform (according to IEC 61000-4-2)**

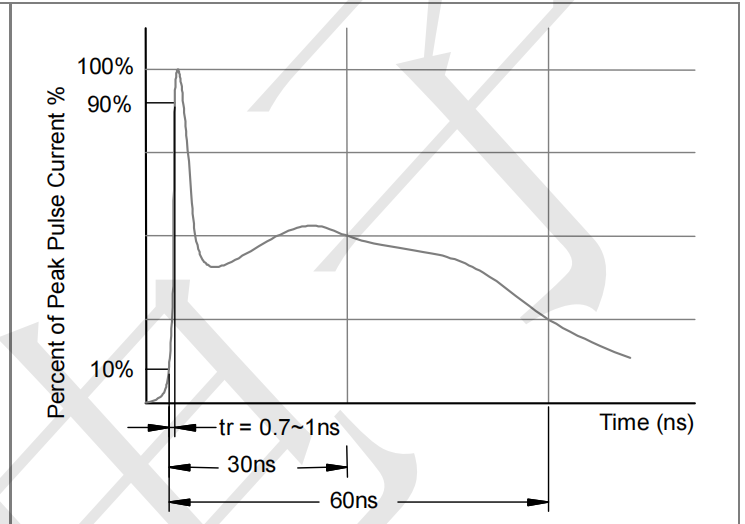

**Fig3. Power Derating Curve**

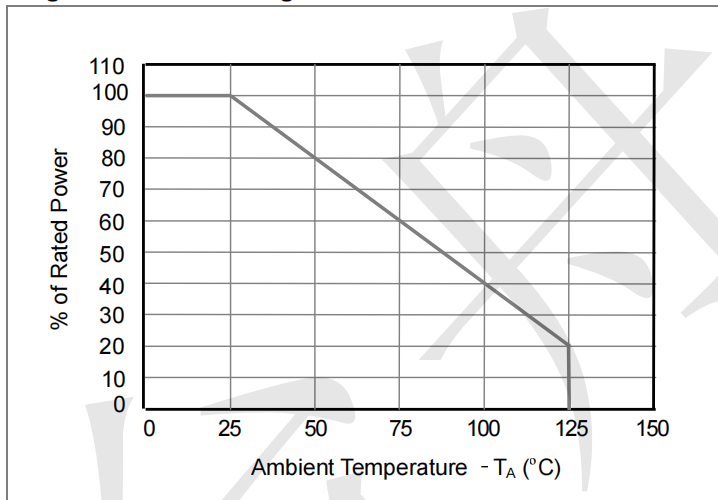

**Outline Drawing - SOT23-6**

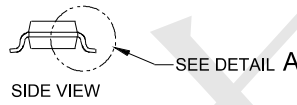
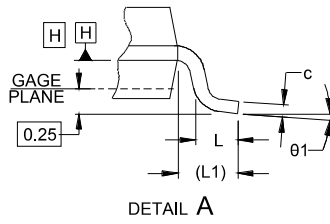
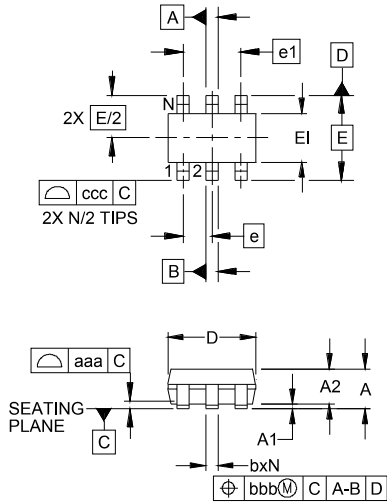

DIM	INCHES		MILLIMETERS	
	MIN	NOM MAX	MIN	NOM MAX
A	.035	-.057	0.90	- 1.45
A1	.000	-.006	0.00	- 0.15
A2	.035	.045 .051	.90	1.15 1.30
b	.010	-.020	0.25	- 0.50
c	.003	-.009	0.08	- 0.22
D	.110 .114 .118		2.80 2.90 3.00	
E1	.060 .063 .069		1.50 1.60 1.75	
E	.110 BSC		2.80 BSC	
e	.037 BSC		0.95 BSC	
e1	.075 BSC		1.90 BSC	
L	.012 .018 .024		0.30 0.45 0.60	
L1	(0.024)		(0.60)	
N	6		6	
theta 1	0°	- 10°	0°	- 10°
aaa	.004		0.10	
bbb	.008		0.20	
ccc	.008		0.20	

**Land Pattern - SOT23-6**

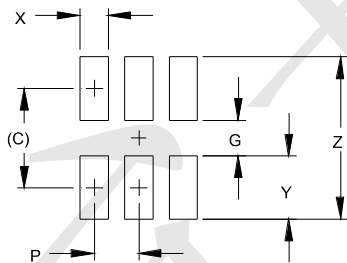

DIMENSIONS		
DIM	INCHES	MILLIMETERS
C	(.098)	(2.50)
G	.055	1.40
P	.037	0.95
X	.024	0.60
Y	.043	1.10
Z	.141	3.60