

WL2834CA

1A, 5.5V, Ultra Low Dropout Linear Regulator

[Http://www.sh-willsemi.com](http://www.sh-willsemi.com)

Descriptions

The WL2834CA is a 1 A VLDO equipped with NMOS pass transistor and a separate bias supply voltage (V_{BIAS}). The device provides very stable, accurate output voltage with low noise suitable for space constrained, noise sensitive applications. In order to optimize performance for battery operated portable applications, the WL2834CA features low I_Q consumption.

The WL2834CA is available in 0.8x1.2mm 6-Ball wafer level Chip-Scale-Package. Standard products are Pb-free and Halogen-free.

Features

- Input Voltage Range : 0.5~5V
- Bias Voltage Range : 3.0~5.5V
- Output Voltage Range : 0.5V~3.6V
- Low Dropout : 85mV Typ. @ 1 A
- Bias Input Current : 44 μ A Typ.@enable
- Bias Input Current : 0.5 μ A Typ.@disable
- Output voltage accuracy : $\pm 0.5\%$ @25 $^{\circ}$ C
- Logic Level Enable Input for ON/OFF Control
- Output Active Discharge Function
- Stable with a 10 μ F Output Ceramic Capacitor

Applications

- Battery-powered Equipment
- Smart phones , Tablets
- Cameras, DVRs, STB and Camcorders

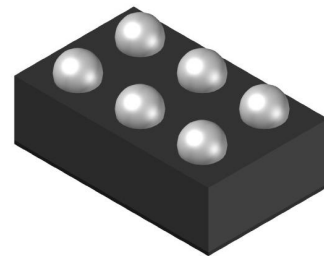

CSP-6L (Bottom View)

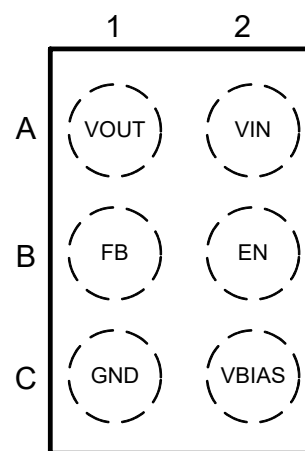

Pin Configuration (Top View)

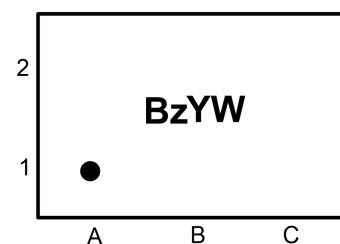

Marking

- Bz** = Device code
- Y** = Year code
- W** = Week code

Order Information

Ordering No.	V_{OUT} (V)	Marking	Shipping
WL2834CA-6/TR	ADJ	BzYW	Tape and Reel, 3000

Typical Application

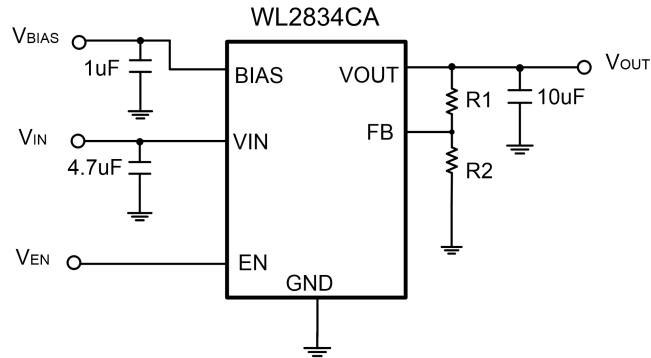

$$V_{OUT} = V_{REF} \times (1 + R1/R2)$$

Note: It is recommended to keep the total serial resistance of resistors (R1 + R2) no greater than 100kΩ .

PIN Functions

PIN	Symbol	Description
A1	VOUT	Regulated Output Voltage pin
A2	VIN	Input Voltage Supply pin
B1	FB	Adjustable Regulator Feedback Input. Connect to output voltage resistor divider central node
B2	EN	Enable pin. Driving this pin high enables the regulator. Driving this pin low puts the regulator into shutdown mode.
C1	GND	Ground pin
C2	VBIAS	Bias voltage supply for internal control circuits. This pin is monitored by internal Under-Voltage Lockout Circuit.

Block Diagram

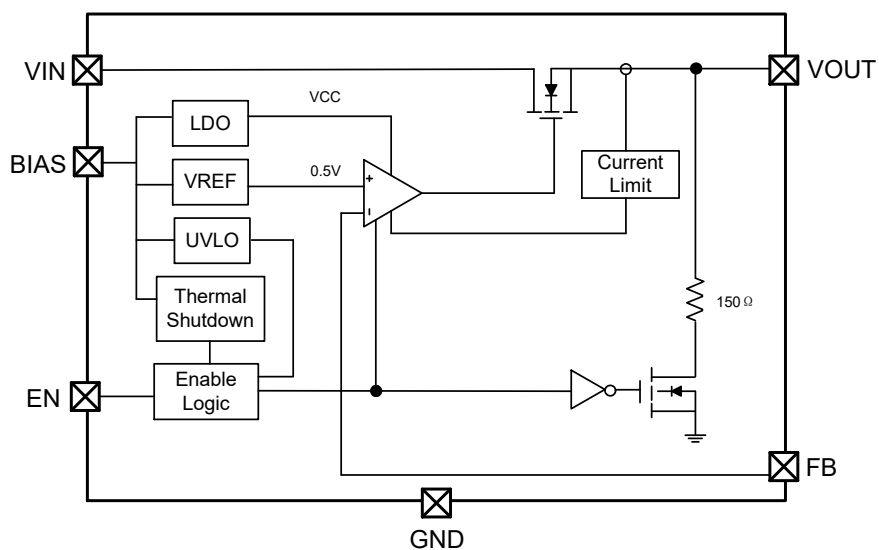

Absolute Maximum Ratings

Parameter	Symbol	Value	Unit
Input Voltage	V_{IN}	-0.3 to 6	V
Output Voltage	V_{OUT}	-0.3 to $(V_{IN}+0.3) \leq 6$	V
Chip Enable, Bias, FB Input	V_{EN}, V_{BIAS}, V_{FB}	-0.3 to 6	V
Output Short Circuit Duration	t_{SC}	unlimited	S
Maximum Junction Temperature	T_J	150	°C
Storage Temperature	T_{STG}	-55 to 150	°C
ESD Capability, Human Body Model	ESD_{HBM}	2000	V
ESD Capability, Machine Model	ESD_{MM}	200	V

These are stress ratings only. Stresses exceeding the range specified under “Absolute Maximum Ratings” may cause substantial damage to the device. Functional operation of this device at other conditions beyond those listed in the specification is not implied and prolonged exposure to extreme conditions may affect device reliability.

Recommended Operating Conditions

Parameter	Value	Unit
Supply Input Voltage, V_{IN}	$V_{OUT} + V_{DO}$ to 5	V
Supply Input Voltage, V_{BIAS} (Note 1)	3.0 to 5.5	V
Junction Temperature Range	-40 to 125	°C
Ambient Temperature Range	-40 to 85	°C
Thermal Resistance, $R_{\theta JA}$ (Note 2)	114	°C/W

Note 1 . V_{BIAS} has to be equal or bigger than $V_{OUT}+1.6V$

Note 2 . $R_{\theta JA}$ is measured under natural convection (still air) at $T_A = 25^\circ C$ with the component mounted on 1.5*1.5 inch² FR-4 , copper (1 inch²/2oz)

Electronics Characteristics ($V_{BIAS} = 3V$, or $(V_{OUT} + 1.6V)$, whichever is greater, $V_{IN} = V_{OUT(Normal)} + 0.3V$, $I_{OUT} = 1mA$, $V_{EN} = 2.2V$, $C_{IN} = 4.7\mu F$, $C_{OUT} = 10\mu F$, $C_{BIAS} = 1\mu F$, $T_A = 25^\circ C$, unless otherwise specified).

Parameter	Symbol	Condition	Min.	Typ.	Max.	Unit
Operating Input Voltage Range	V_{IN}		$V_{OUT} + V_{DO}$		5 & $< V_{BIAS}$	V
Operating Bias Voltage Range	V_{BIAS}		$(V_{OUT} + 1.60) \geq 3.0$		5.5	V
Under-Voltage Lockout	V_{UVLO}	V_{BIAS} Rising		1.65		V
		Hysteresis		0.2		
Reference Voltage	V_{REF}	WL2834CA, $T_A = 25^\circ C$	0.495	0.5	0.505	V
Output Voltage Accuracy	V_{OUT}	$T_A = 25^\circ C$		± 0.5		%
Output Voltage Accuracy	V_{OUT}	$V_{OUT} + 0.3 V \leq V_{IN} \leq V_{OUT} + 1.0 V$, 3.0 V or $(V_{OUT} + 1.6 V)$, whichever is greater $< V_{BIAS} < 5.5 V$, $1mA < I_{OUT} < 1.0 A$ $T_J = -40 \sim 85^\circ C$ (note 3)	-1.0		+1.0	%
V_{IN} Line Regulation	LineReg	$V_{OUT} + 0.3 V \leq V_{IN} \leq V_{BIAS}$		0.1		mV
V_{BIAS} Line Regulation	LineReg	3.0 V or $(V_{OUT} + 1.6 V)$, whichever is greater $< V_{BIAS} < 5.5 V$		0.1		mV
Load Regulation	LoadReg	$I_{OUT} = 1mA$ to 1.0 A		2.0		mV
V_{IN} Dropout Voltage	V_{DO}	$I_{OUT} = 1.0 A$		85	106	mV
V_{BIAS} Dropout Voltage	V_{DO}	$I_{OUT} = 1.0 A$, $V_{IN} = V_{BIAS}$		1.0	1.5	V
Short Current	I_{SHORT}	$V_{OUT} = 0V$	300		610	mA
Output Current Limit	I_{LIM}	$V_{OUT} = 90\% V_{OUT}$	5.0* I_{SHORT}	5.2* I_{SHORT}		mA
FB Pin Operating Current	I_{FB}	$V_{FB} = 0.5V$, $V_{EN} = V_{IN} = V_{BIAS} = 3.6V$		0.01	0.5	μA
Bias Pin Quiescent Current	I_{BIASQ}	$V_{BIAS} = 3.0 V$, $I_{OUT} = 0mA$		44	60	μA
Bias Pin Disable Current	$I_{BIAS(DIS)}$	$V_{EN} \leq 0.4V$		0.5	1	μA
V_{IN} Pin Disable Current	$I_{VIN(DIS)}$	$V_{EN} \leq 0.4V$		0.07	1	μA

Parameter	Symbol	Condition	Min.	Typ.	Max.	Unit
EN Pin Threshold Voltage	$V_{EN(H)}$	EN Input Voltage "H"	1.4			V
	$V_{EN(L)}$	EN Input Voltage "L"			0.4	
EN Pull Down Current	I_{EN}	$V_{EN} = 5.5 V$		0.4	1	μA
Turn-On Time	t_{ON}	From assertion of V_{EN} to $V_{OUT} = 98\% V_{OUT}$, $V_{OUT} = 1.2 V$, $C_{OUT} = 10\mu F$		180	320	μS
Power Supply Rejection Ratio	$PSRR_{(VIN)}$	V_{IN} to V_{OUT} , $f = 1 kHz$, $I_{OUT} = 10mA$, $V_{IN} \geq V_{OUT} + 0.5 V$, $V_{OUT} = 1.2 V$, $C_{OUT} = 10\mu F$		80		dB
	$PSRR_{(VBias)}$	V_{BIAS} to V_{OUT} , $f = 1 kHz$, $I_{OUT} = 10mA$, $V_{IN} \geq V_{OUT} + 0.5 V$, $V_{OUT} = 1.2 V$, $C_{OUT} = 10\mu F$		77		
Output Noise Voltage	V_N	$f = 10kHz$ to $100Hz$, $V_{IN} = V_{OUT} + 0.5 V$, $V_{OUT} = 1.2V$, $C_{OUT} = 10\mu F$, $I_{OUT} = 0mA$		50		μV_{RMS}
		$f = 10kHz$ to $100Hz$, $V_{IN} = V_{OUT} + 0.5 V$, $V_{OUT} = 1.2V$, $C_{OUT} = 10\mu F$, $I_{OUT} = 10mA$		28		
Thermal Shutdown Threshold	T_{SDH}	Temperature rising (note 3)		165		$^{\circ}C$
	T_{SDL}	Temperature falling (note 3)		135		
Output Discharge Pull-Down	R_{DISCH}	$V_{EN} \leq 0.4 V$, $V_{OUT} = 0.5 V$		150	220	Ω

Note 3 . Guaranteed by design.

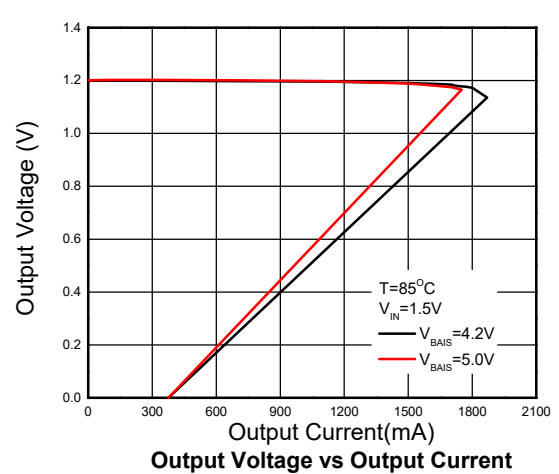
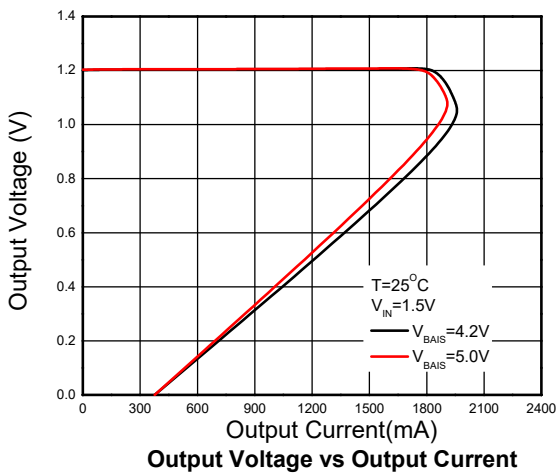
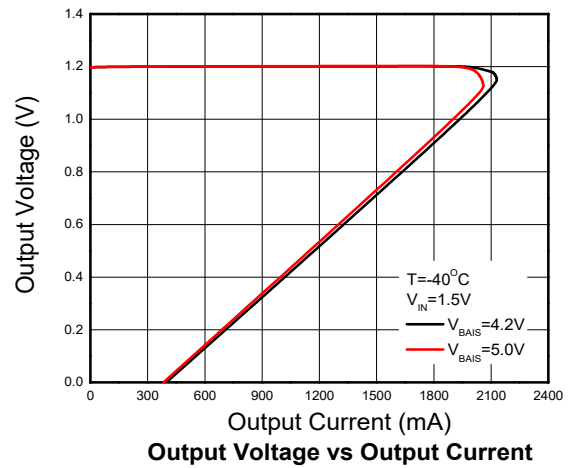
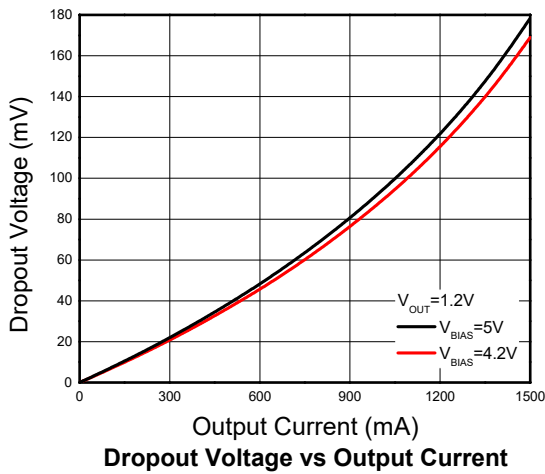
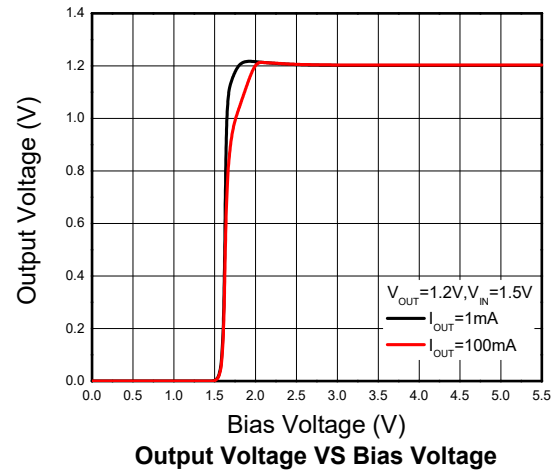
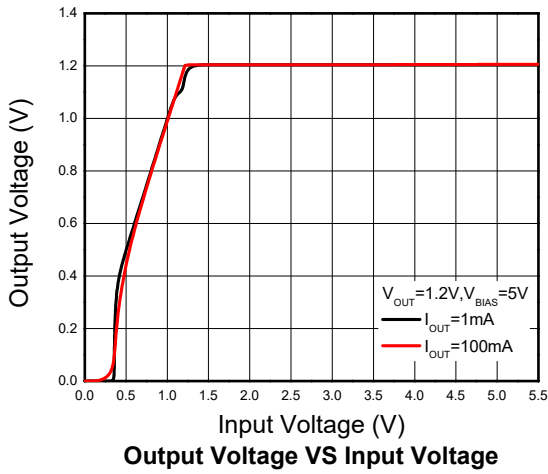
Typical Characteristics

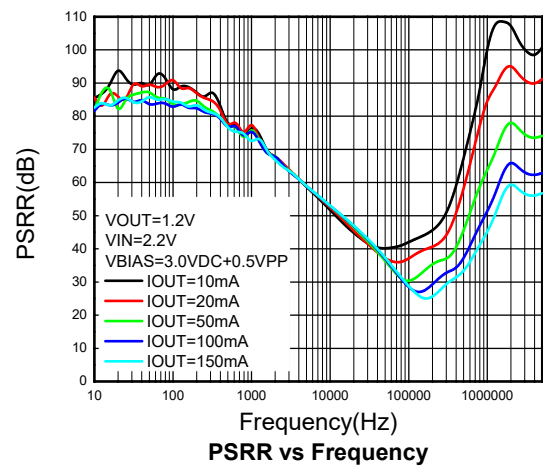
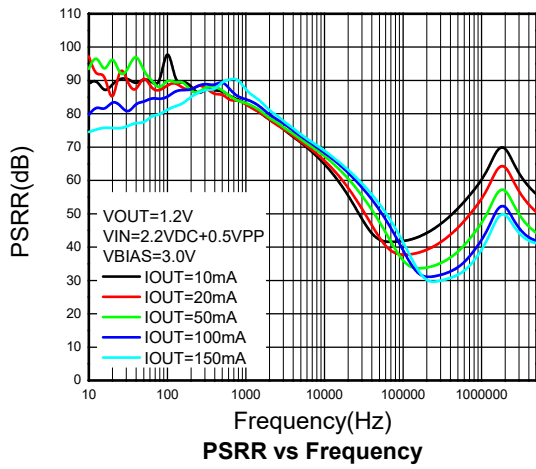

Power on sequence

The Power on sequence of V_{BIAS} is no later than V_{IN} , or else, the V_{OUT} will fail to output.

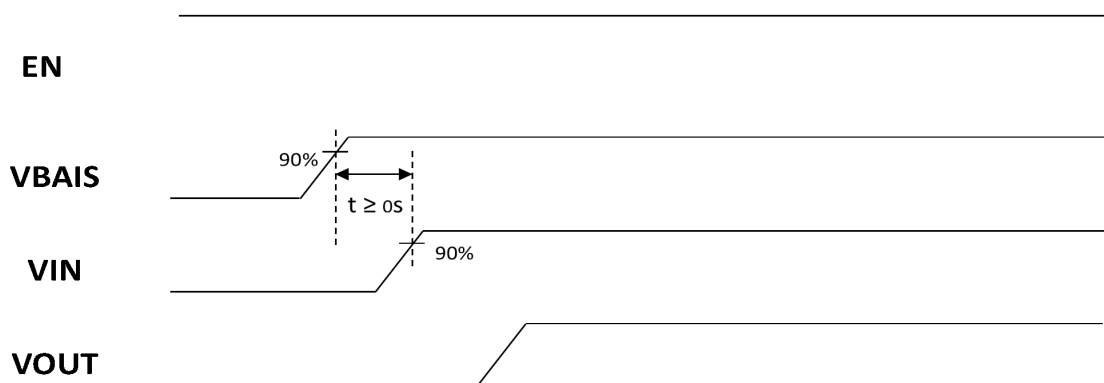

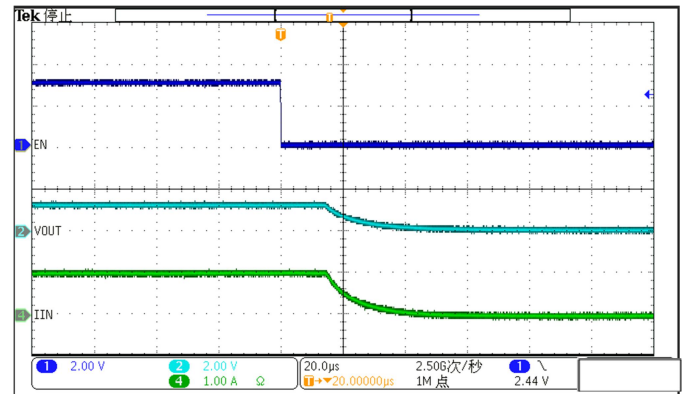
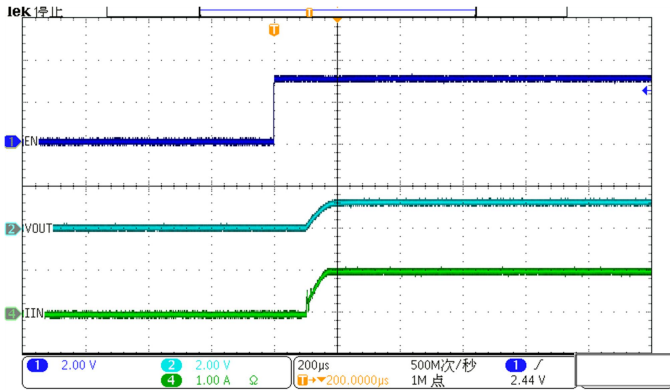
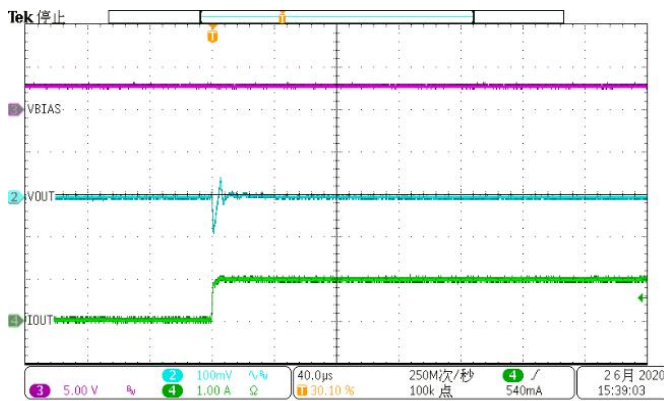
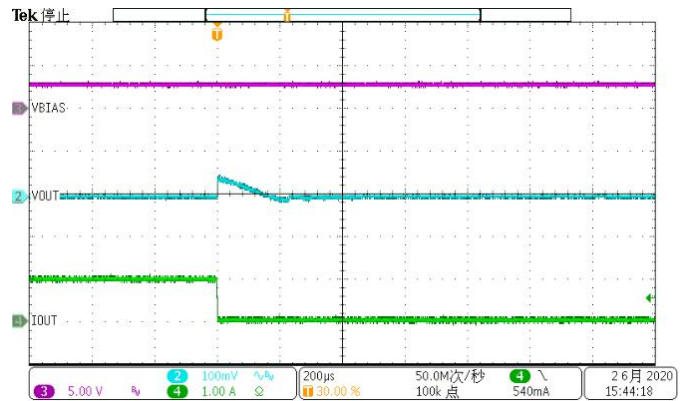
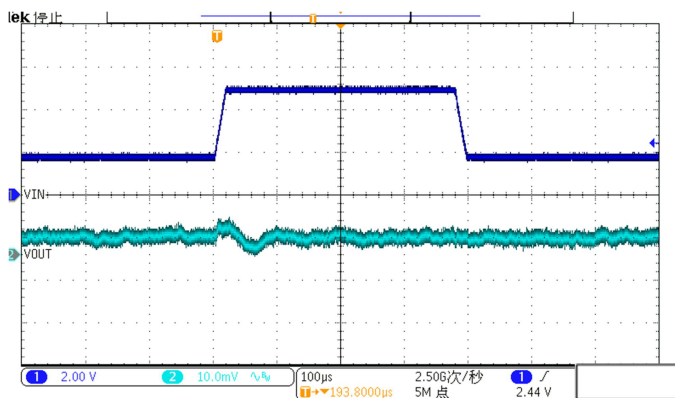
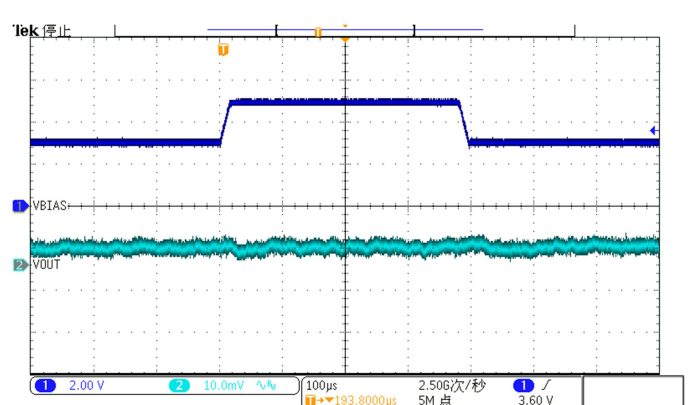
EN Soft-Start & Shutdown
 $V_{IN}=1.5V, V_{BIAS}=3V, V_{OUT}=1.2V, I_{OUT}=1A$

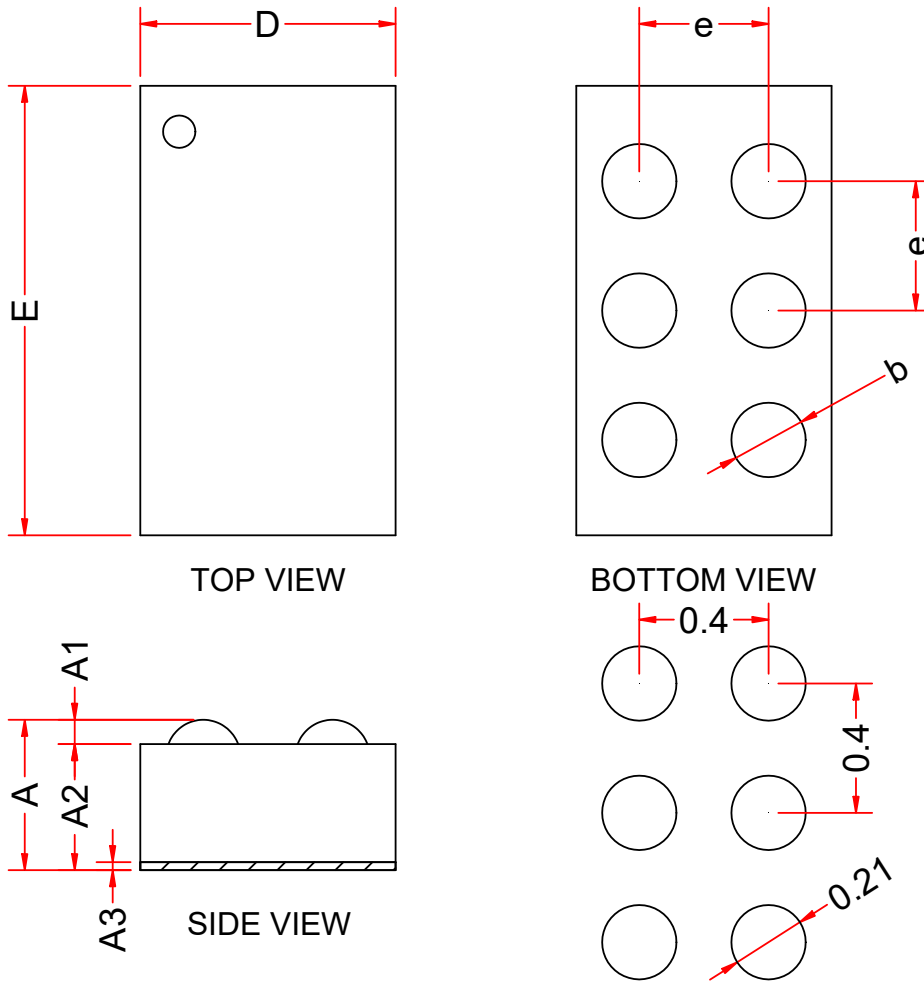
Load Transient
 $V_{IN}=1.35V, V_{BIAS}=3.3V, V_{OUT}=1.2V, I_{OUT}=1mA \sim 1A$ in 1us

 $V_{IN}=1.35V, V_{BIAS}=3.3V, V_{OUT}=1.2V, I_{OUT}=1A \sim 1mA$ in 1us

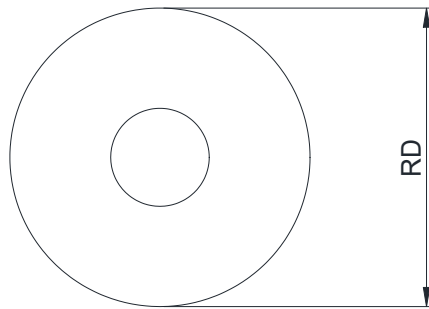
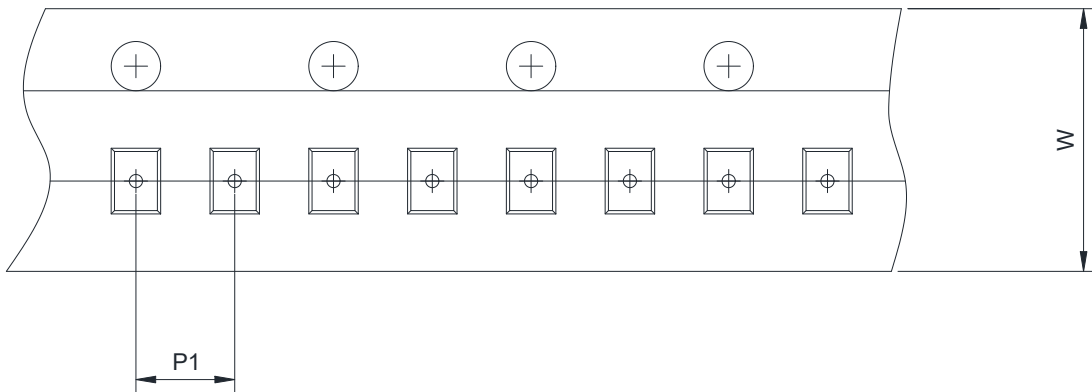
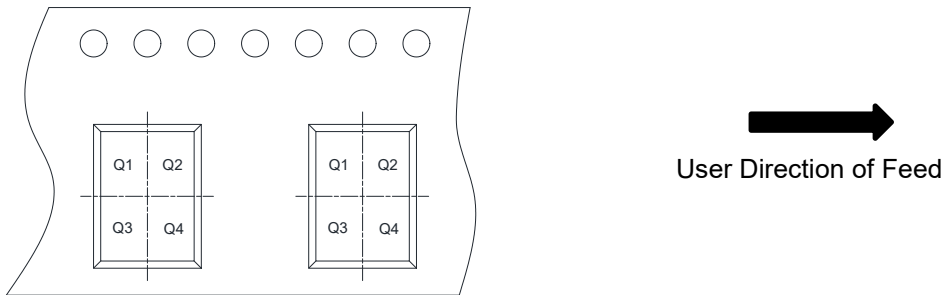
Line Transient
 $V_{IN}=1.5V \sim 5V$ in 20us, $V_{BIAS}=5.0V, V_{OUT}=1.2V, I_{OUT}=1mA$

 $V_{IN}=1.5V, V_{BIAS}=3V \sim 5V$ in 20us, $V_{OUT}=1.2V, I_{OUT}=1mA$

PACKAGE OUTLINE DIMENSIONS
WLCSP-6L

RECOMMENDED LAND PATTERN(Unit:mm)

Symbol	Dimensions in Millimeters		
	Min.	Typ.	Max.
A	0.26	0.31	0.35
A1	0.04	0.06	0.08
A2	0.22	0.25	0.27
A3	0.025 Typ.		
D	0.74	0.77	0.80
E	1.14	1.17	1.20
e	0.40 BSC.		
b	0.25	0.27	0.29

TAPE AND REEL INFORMATION
Reel Dimensions

Tape Dimensions

Quadrant Assignments For PIN1 Orientation In Tape

RD	Reel Dimension	<input checked="" type="checkbox"/> 7inch <input type="checkbox"/> 13inch
W	Overall width of the carrier tape	<input checked="" type="checkbox"/> 8mm <input type="checkbox"/> 12mm <input type="checkbox"/> 16mm
P1	Pitch between successive cavity centers	<input type="checkbox"/> 2mm <input checked="" type="checkbox"/> 4mm <input type="checkbox"/> 8mm
Pin1	Pin1 Quadrant	<input checked="" type="checkbox"/> Q1 <input type="checkbox"/> Q2 <input type="checkbox"/> Q3 <input type="checkbox"/> Q4