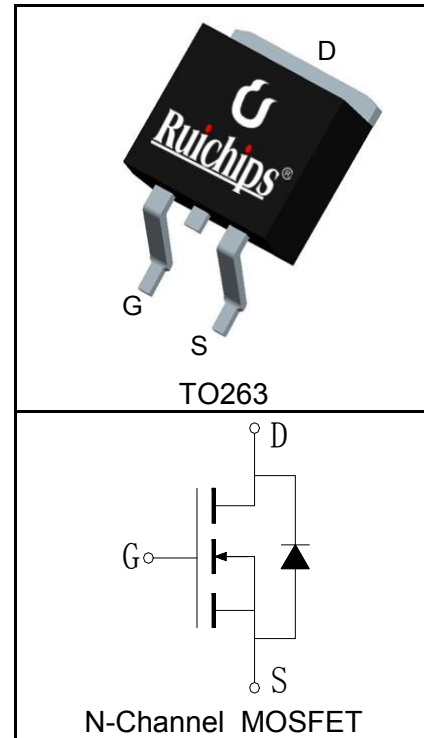

Features

- 60V/180A,
 $R_{DS(ON)} = 3.4m\Omega(Typ.)@V_{GS}=10V$
- Super High Dense Cell Design
- Ultra Low On-Resistance
- 100% avalanche tested
- Lead Free and Green Devices Available (RoHS Compliant)

Applications

- DC-DC Converters and Off-line UPS
- Switching Applications

Pin Description

Absolute Maximum Ratings

Symbol	Parameter	Rating	Unit
Common Ratings ($T_C=25^\circ C$ Unless Otherwise Noted)			
V_{DSS}	Drain-Source Voltage	60	V
V_{GSS}	Gate-Source Voltage	± 20	
T_J	Maximum Junction Temperature	175	$^\circ C$
T_{STG}	Storage Temperature Range	-55 to 175	$^\circ C$
I_S	Diode Continuous Forward Current	$T_C=25^\circ C$ 75	A
Mounted on Large Heat Sink			
$I_{DP}^{①}$	300 μs Pulse Drain Current Tested	$T_C=25^\circ C$ 720	A
$I_D^{②}$	Continuous Drain Current($V_{GS}=10V$)	$T_C=25^\circ C$ 180	A
		$T_C=100^\circ C$ 127	
P_D	Maximum Power Dissipation	$T_C=25^\circ C$ 268	W
		$T_C=100^\circ C$ 134	
$R_{\theta JC}$	Thermal Resistance-Junction to Case	0.56	$^\circ C/W$
$R_{\theta JA}$	Thermal Resistance-Junction to Ambient	62.5	$^\circ C/W$
Drain-Source Avalanche Ratings			
$E_{AS}^{③}$	Avalanche Energy, Single Pulsed	440	mJ

Electrical Characteristics ($T_C=25^{\circ}\text{C}$ Unless Otherwise Noted)

Symbol	Parameter	Test Condition	RU6188S			Unit
			Min.	Typ.	Max.	
Static Characteristics						
BV_{DSS}	Drain-Source Breakdown Voltage	$V_{GS}=0V, I_{DS}=250\mu A$	60			V
I_{DSS}	Zero Gate Voltage Drain Current	$V_{DS}=60V, V_{GS}=0V$			1	μA
		$T_J=125^{\circ}\text{C}$			30	
$V_{GS(th)}$	Gate Threshold Voltage	$V_{DS}=V_{GS}, I_{DS}=250\mu A$	2		4	V
I_{GSS}	Gate Leakage Current	$V_{GS}=\pm 20V, V_{DS}=0V$			± 100	nA
$R_{DS(ON)}^{(4)}$	Drain-Source On-state Resistance	$V_{GS}=10V, I_{DS}=75A$		3.4	4	m Ω
Diode Characteristics						
$V_{SD}^{(4)}$	Diode Forward Voltage	$I_{SD}=75A, V_{GS}=0V$			1.3	V
t_{rr}	Reverse Recovery Time	$I_{SD}=75A, di_{SD}/dt=100A/\mu s$		68		ns
Q_{rr}	Reverse Recovery Charge			137		nC
Dynamic Characteristics ⁽⁵⁾						
R_G	Gate Resistance	$V_{GS}=0V, V_{DS}=0V, F=1\text{MHz}$		1.2		Ω
C_{iss}	Input Capacitance	$V_{GS}=0V,$ $V_{DS}=30V,$ Frequency=1.0MHz		5560		pF
C_{oss}	Output Capacitance			1350		
C_{riss}	Reverse Transfer Capacitance			455		
$t_{d(ON)}$	Turn-on Delay Time	$V_{DD}=30V, I_{DS}=75A,$ $V_{GEN}=10V, R_G=4.7\Omega$		19		ns
t_r	Turn-on Rise Time			33		
$t_{d(OFF)}$	Turn-off Delay Time			67		
t_f	Turn-off Fall Time			105		
Gate Charge Characteristics ⁽⁵⁾						
Q_g	Total Gate Charge	$V_{DS}=48V, V_{GS}=10V,$ $I_{DS}=75A$		128		nC
Q_{gs}	Gate-Source Charge			49		
Q_{gd}	Gate-Drain Charge			37		

- Notes:
- ① Pulse width limited by safe operating area.
 - ② Calculated continuous current based on maximum allowable junction temperature. The package limitation current is 75A.
 - ③ Limited by T_{Jmax} , $I_{AS}=42A, V_{DD}=48V, R_G=50\Omega$, Starting $T_J=25^{\circ}\text{C}$.
 - ④ Pulse test; Pulse width $\leq 300\mu s$, duty cycle $\leq 2\%$.
 - ⑤ Guaranteed by design, not subject to production testing.

Typical Characteristics

Power Dissipation

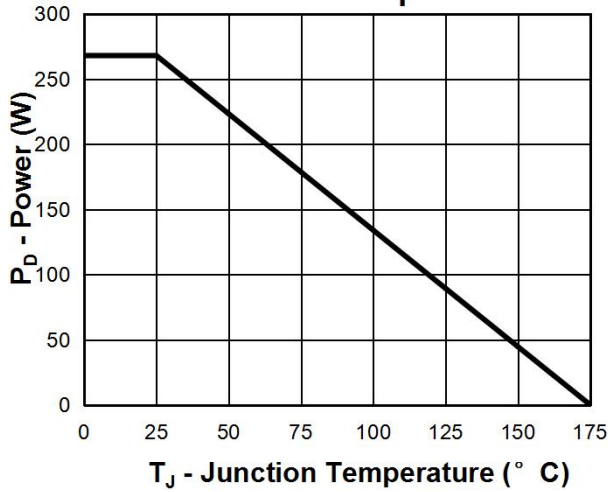

Drain Current

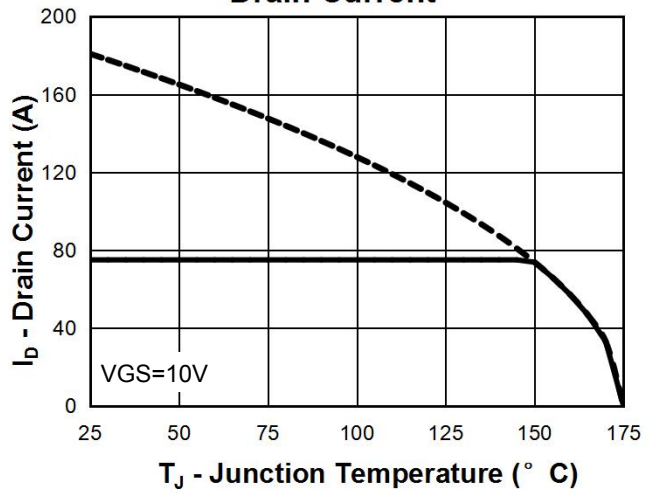

Safe Operation Area

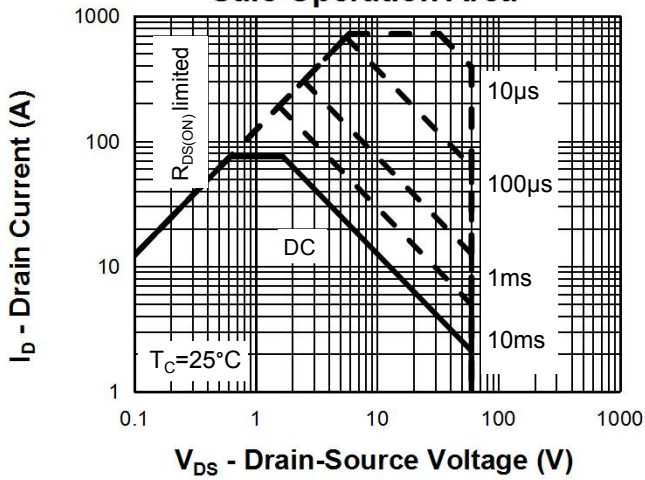

Drain Current

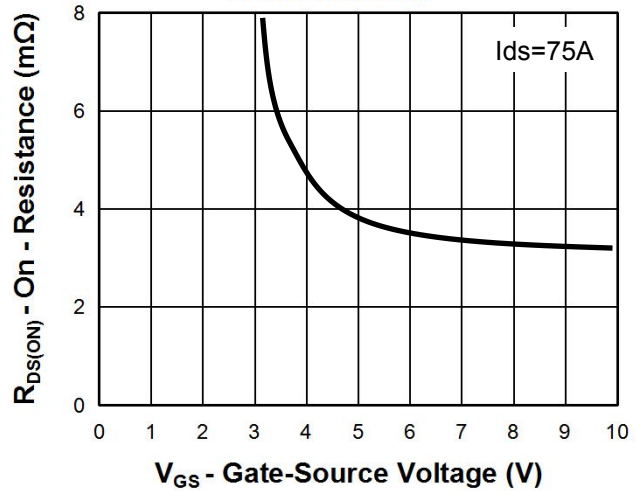

Thermal Transient Impedance

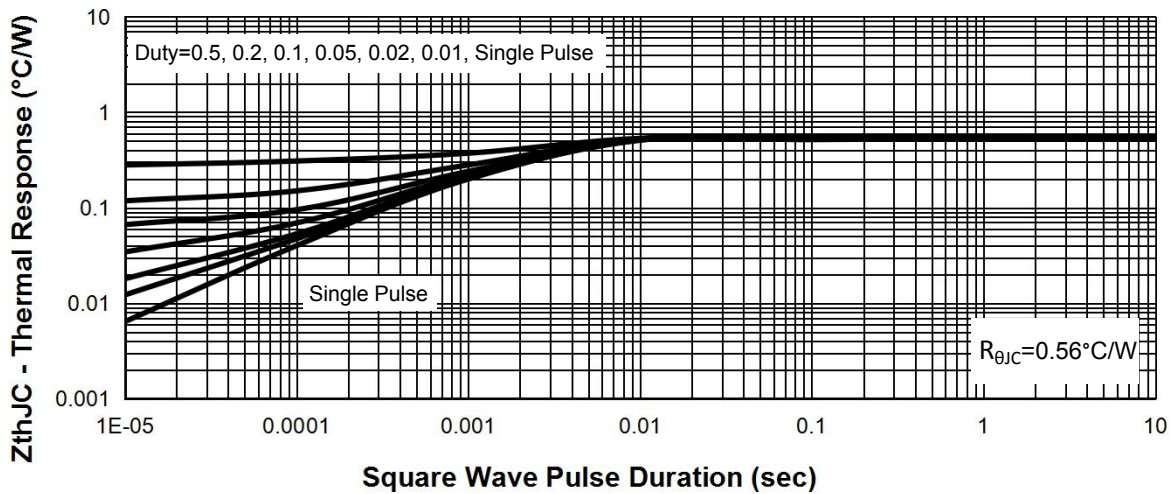

Typical Characteristics

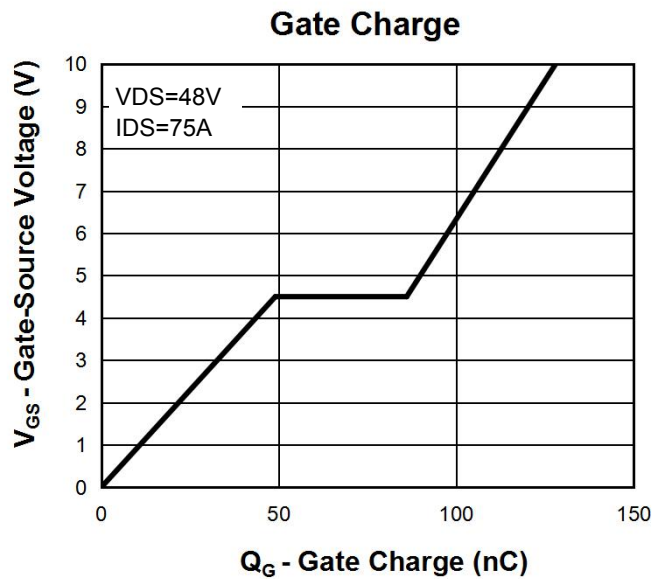
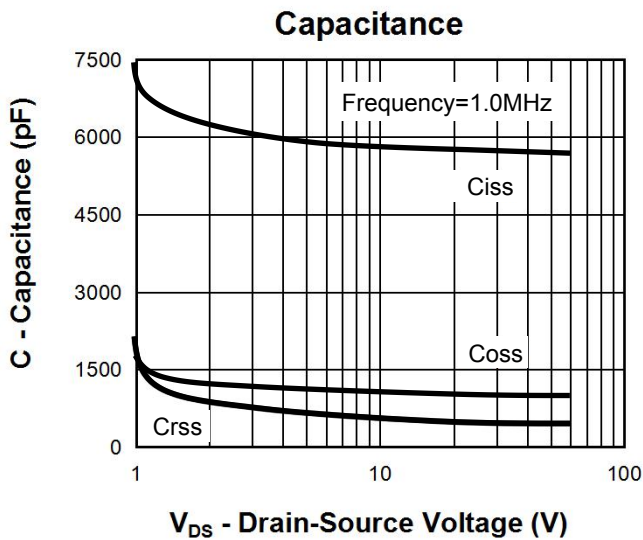
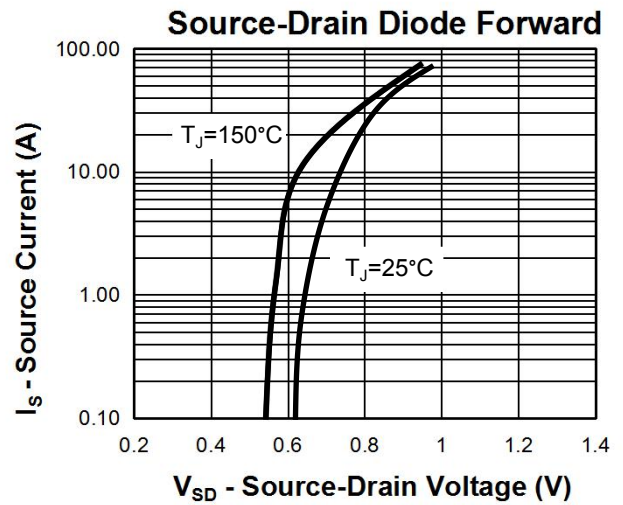
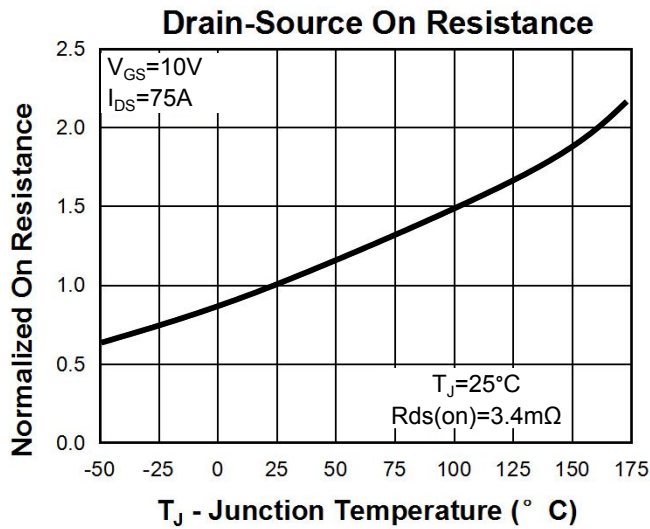
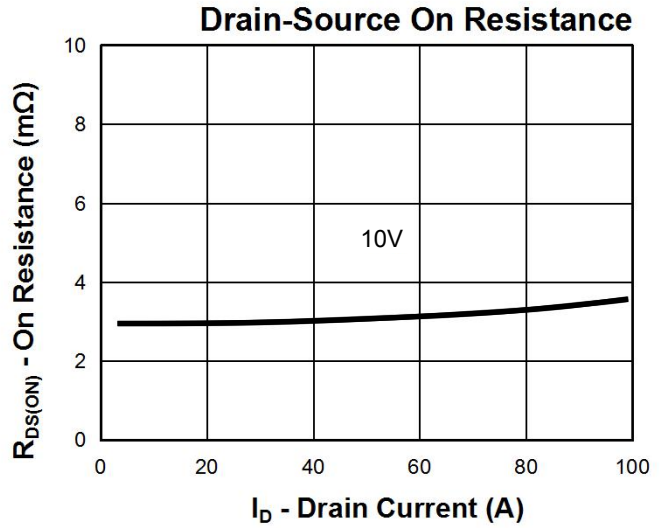
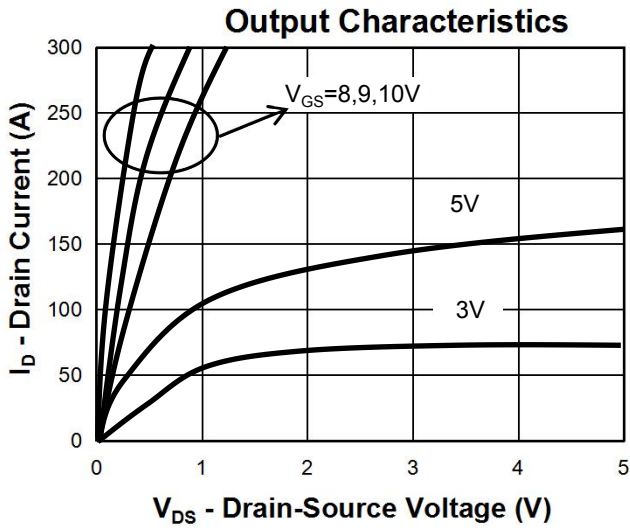

Avalanche Test Circuit and Waveforms

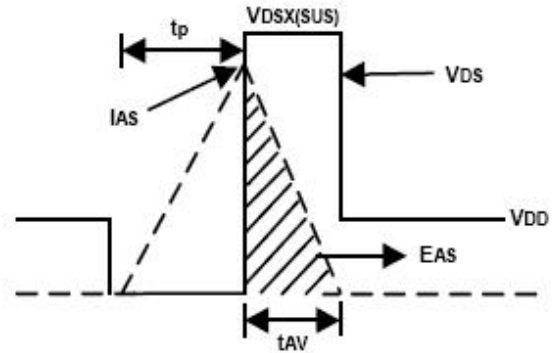
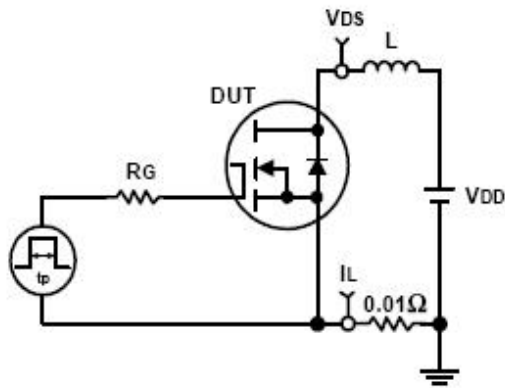

Switching Time Test Circuit and Waveforms

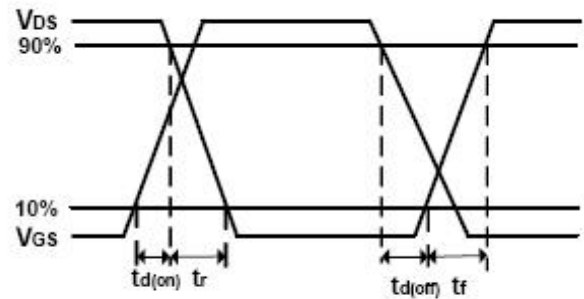
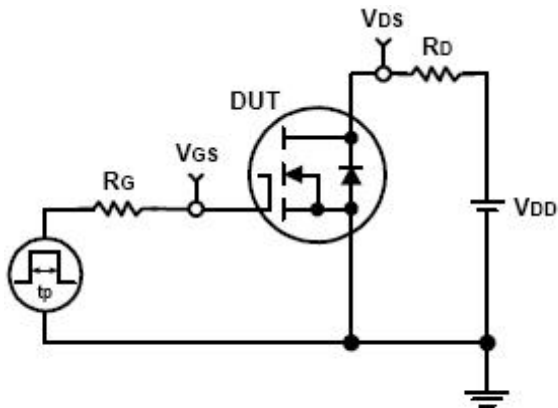

Ordering and Marking Information

Device	Marking	Package	Packaging	Quantity	Reel Size	Tape width
RU6188S-R	RU6188S	TO263	Tape&Reel	800	13"	24mm
RU6188S	RU6188S	TO263	Tube	50	-	-

Package Information

TO263

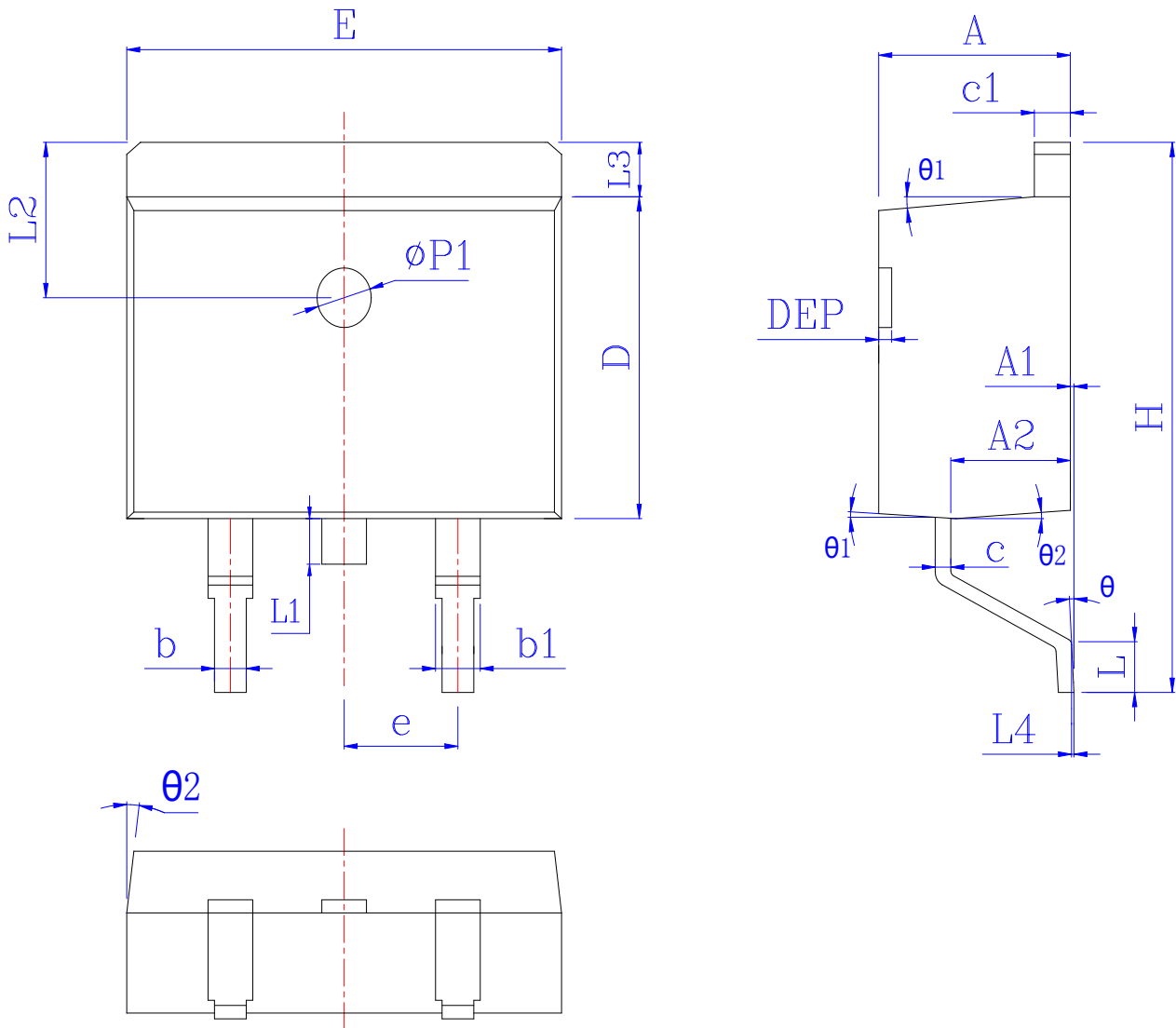

SYMBOL	MM			INCH			SYMBOL	MM			INCH		
	MIN	NOM	MAX	MIN	NOM	MAX		MIN	NOM	MAX	MIN	NOM	MAX
A	4.40	4.55	4.72	0.173	0.179	0.186	L	1.94	2.30	2.60	0.076	0.091	0.102
A1	0.00	0.10	0.25	0.000	0.005	0.010	L3	1.17	1.29	1.40	0.046	0.051	0.055
A2	2.59	2.69	2.79	0.102	0.106	0.110	L1	*	*	1.70	*	*	0.067
b	0.76	*	0.90	0.030	*	0.035	L4	0.25 BSC			0.01 BSC		
b1	1.22	*	1.36	0.048	*	0.054	L2	2.50 REF			0.098 REF		
c	0.33	*	0.47	0.013	*	0.019	θ	0°	*	8°	0°	*	8°
c1	1.22	*	1.32	0.048	*	0.052	θ_1	5°	7°	9°	5°	7°	9°
D	8.60	*	9.29	0.339	*	0.366	θ_2	1°	3°	5°	1°	3°	5°
E	9.95	*	10.26	0.392	*	0.404	DEP	0.05	0.10	0.20	0.002	0.004	0.008
e	2.54BSC			0.100BSC			$\Phi p1$	1.40	1.50	1.60	0.055	0.059	0.063
H	14.70	15.10	15.79	0.579	0.594	0.622							