

为 您 的 产 品 保 驾 护 航

PRODUCT DATASHEET

Surface Mount PTC Devices

ASMD1206 Series Surface Mount PTC Devices



Description

The ASMD1206 series provides miniature surface mount overcurrent protection with holding current from 0.05A to 3.5A.

This series is suitable for wide range of applications in modern electronics where space is limited.

Features



- RoHS compliant and lead-free
- Low profile
- Halogen-free
- Fast response to fault current
- Compact design saves board space
- Compatible with high temperature solders

Agency Approvals

Agency	File Number
	E472196

Applications

- Battery PCM
- Game console port protection
- USB hubs, ports and peripherals
- Optical disk drives
- Set-top-box and HDMI
- General electronics

Regulation	Standard
	2002/95/EC
	EN14582

Performance Specification

Model	V _{max} (V dc)	I _{max} (A)	I _{hold} @25°C (A)	I _{trip} @25°C (A)	P _d Typ. (W)	Maximum Time To Trip		Resistance	
						Current (A)	Time (Sec)	R _{i min} (Ω)	R _{1max} (Ω)
ASMD1206-005	60.0	100	0.05	0.15	0.4	0.25	1.5	3.60	50
ASMD1206-005-24V	24.0	100	0.05	0.15	0.4	0.25	1.5	3.60	50
ASMD1206-010	60.0	100	0.1	0.25	0.4	0.5	1.0	1.60	15
ASMD1206-010-24V	24.0	100	0.1	0.25	0.4	0.5	1.0	1.60	15
ASMD1206-012	60.0	100	0.12	0.29	0.4	0.5	1.0	1.60	15
ASMD1206-012-24V	24.0	100	0.12	0.29	0.4	0.5	1.0	1.60	15
ASMD1206-016	16.0	100	0.16	0.37	0.4	1.0	0.3	1.00	6.0
ASMD1206-016-24V	24.0	100	0.16	0.37	0.4	1.0	0.3	1.00	6.0
ASMD1206-016-33V	33.0	100	0.16	0.37	0.4	1.0	0.3	1.00	6.0
ASMD1206-020	24.0	100	0.2	0.46	0.6	8.0	0.08	0.35	3.5
ASMD1206-020-30V	30.0	100	0.2	0.46	0.6	8.0	0.08	0.35	3.5
ASMD1206-020-48V	48.0	100	0.2	0.46	0.6	8.0	0.08	0.35	3.5
ASMD1206-025	16.0	100	0.25	0.5	0.6	8.0	0.08	0.35	2.7
ASMD1206-025-24V	24.0	100	0.25	0.5	0.6	8.0	0.08	0.35	2.7
ASMD1206-025-30V	30.0	100	0.25	0.5	0.6	8.0	0.08	0.35	2.7
ASMD1206-025-48V	48.0	100	0.25	0.5	0.6	8.0	0.08	0.35	2.7
ASMD1206-035	6.0	100	0.35	0.75	0.6	8.0	0.1	0.25	1.5
ASMD1206-035-16V	16.0	100	0.35	0.75	0.6	8.0	0.1	0.25	1.5
ASMD1206-035-30V	30.0	100	0.35	0.75	0.6	8.0	0.1	0.25	1.5
ASMD1206-050	6.0	100	0.5	1.0	0.6	8.0	0.1	0.15	0.7
ASMD1206-050-13.2V	13.2	100	0.5	1.0	0.6	8.0	0.1	0.15	0.7
ASMD1206-050-16V	16.0	100	0.5	1.0	0.6	8.0	0.1	0.15	0.7
ASMD1206-050-30V	30.0	100	0.5	1.0	0.6	8.0	0.1	0.15	0.7
ASMD1206-075	6.0	100	0.75	1.5	0.6	8.0	0.2	0.09	0.5
ASMD1206-075-16V	16.0	100	0.75	1.5	0.6	8.0	0.2	0.09	0.5
ASMD1206-075-30V	30.0	100	0.75	1.5	0.6	8.0	0.2	0.09	0.5
ASMD1206-100	6.0	100	1.0	1.8	0.6	8.0	0.3	0.05	0.27
ASMD1206-100-16V	16.0	100	1.0	1.8	0.6	8.0	0.3	0.05	0.27
ASMD1206-100-24V	24.0	100	1.0	1.8	0.6	8.0	0.3	0.05	0.27
ASMD1206-110	6.0	100	1.1	2.2	0.6	8.0	0.3	0.04	0.25
ASMD1206-110-16V	16.0	100	1.1	2.2	0.6	8.0	0.3	0.04	0.25
ASMD1206-110-24V	24.0	100	1.1	2.2	0.6	8.0	0.3	0.04	0.25
ASMD1206-150	6.0	100	1.5	3.0	0.8	8.0	0.3	0.025	0.13
ASMD1206-150-13.2V	13.2	100	1.5	3.0	0.8	8.0	0.3	0.025	0.13
ASMD1206-200	6.0	100	2.0	3.5	0.8	8.0	1.5	0.015	0.08
ASMD1206-200-12V	12.0	100	2.0	3.5	0.8	8.0	1.5	0.015	0.08
ASMD1206-200-16V	16.0	100	2.0	3.5	0.8	8.0	1.5	0.015	0.08
ASMD1206-260	6.0	100	2.6	5.2	0.8	8.0	2.0	0.01	0.06
ASMD1206-300	6.0	100	3.0	6.0	1.0	8.0	4.0	0.01	0.05
ASMD1206-350	6.0	100	3.5	7.0	1.2	10.0	5.0	0.005	0.04

I_{hold} = Hold Current. Maximum current device will not trip in 25°C still air.

I_{trip} = Trip Current. Minimum current at which the device will always trip in 25°C still air.

V_{max} = Maximum operating voltage device can withstand without damage at rated current (I_{max}).

I_{max} = Maximum fault current device can withstand without damage at rated voltage (V_{max}).

P_d = Power dissipation when device is in the tripped state in 25°C still air environment at rated voltage.

$R_{i min/max}$ = Minimum/Maximum device resistance prior to tripping at 25°C.

R_{1max} = Maximum device resistance is measured one hour post reflow.

CAUTION : Operation beyond the specified ratings may result in damage and possible arcing and flame.

Environmental Specifications

Test	Conditions	Resistance change
Passive aging	+85°C, 1000 hrs.	±5% typical
Humidity aging	+85°C, 85% R.H. , 168 hours	±5% typical
Thermal shock	+85°C to -40°C, 20 times	±33% typical
Resistance to solvent	MIL-STD-202,Method 215	No change
Vibration	MIL-STD-202,Method 201	No change
Ambient operating conditions : - 40 °C to +85 °C		

Maximum surface temperature of the device in the tripped state is 125 °C

Thermal Derating Curve

Derating Curves for ASMD1206 Series

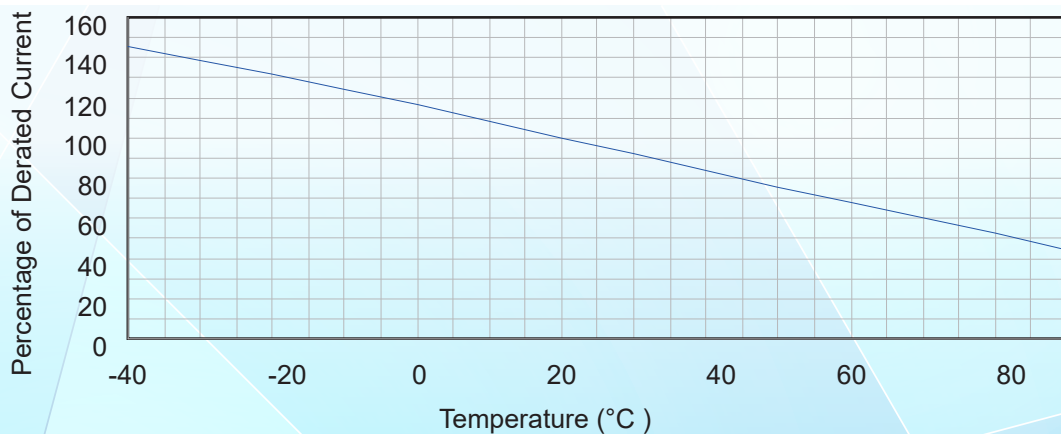

Average Time-Current Curve

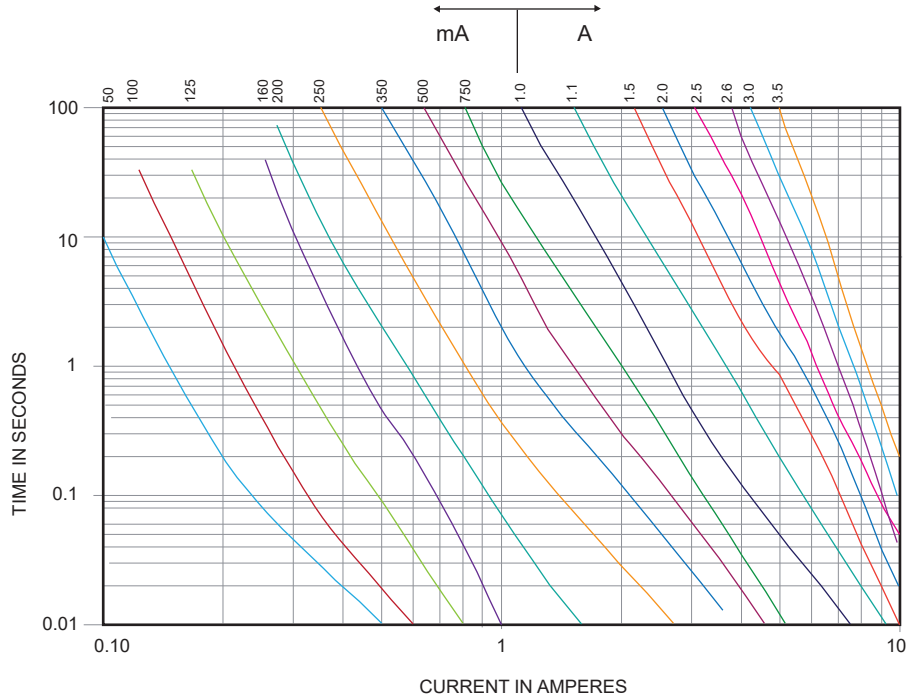

Thermal Derating Chart

Model	Maximum ambient operating temperature (T_{mao}) vs. hold current (I_{hold})								
	- 40°C	- 20°C	0°C	25°C	40°C	50°C	60°C	70°C	85°C
ASMD1206-005	0.074	0.066	0.058	0.05	0.0425	0.0375	0.035	0.03	0.0275
ASMD1206-010	0.148	0.132	0.116	0.10	0.085	0.075	0.07	0.06	0.055
ASMD1206-012	0.18	0.16	0.14	0.12	0.10	0.09	0.08	0.07	0.07
ASMD1206-016	0.24	0.21	0.18	0.16	0.14	0.13	0.12	0.11	0.10
ASMD1206-020	0.30	0.26	0.23	0.20	0.17	0.15	0.14	0.12	0.11
ASMD1206-025	0.37	0.33	0.29	0.25	0.22	0.20	0.17	0.15	0.12
ASMD1206-035	0.50	0.45	0.40	0.35	0.30	0.27	0.24	0.21	0.15
ASMD1206-050	0.71	0.64	0.57	0.50	0.42	0.39	0.35	0.31	0.25
ASMD1206-075	1.14	1.01	0.88	0.75	0.65	0.59	0.54	0.49	0.41
ASMD1206-100	1.45	1.31	1.15	1.00	0.84	0.77	0.69	0.61	0.48
ASMD1206-110	1.60	1.45	1.30	1.10	0.95	0.80	0.72	0.66	0.55
ASMD1206-150	2.18	1.94	1.72	1.50	1.28	1.17	1.06	0.96	0.77
ASMD1206-200	2.88	2.63	2.34	2.00	1.74	1.58	1.42	1.17	0.93
ASMD1206-260	3.43	3.22	2.93	2.60	2.23	2.03	1.87	1.57	1.35
ASMD1206-300	4.05	3.66	3.36	3.00	2.50	2.28	2.00	1.62	1.35
ASMD1206-350	4.65	4.23	3.92	3.50	2.92	2.68	2.35	1.91	1.42

Soldering Parameters

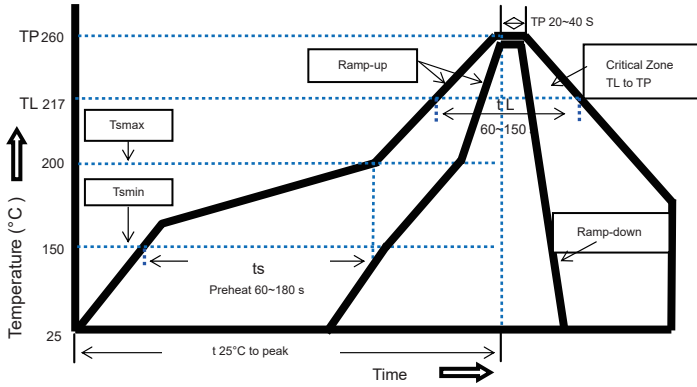

Recommended reflow methods: IR, vapor phase oven, hot air oven, N2 environment for lead-free
 Recommended maximum paste thickness is 0.25mm
 Devices can be cleaned using standard industry methods and solvents.

Note 1: All temperature refer to topside of the package, measured on the package body surface.
 Note 2: If reflow temperatures exceed the recommended profile, devices may not meet the performance requirements.

Profile Feature	Pb-Free Assembly
Average Ramp-Up Rate (Ts max to T p)	3°C/second max.
Preheat	
-Temperature Min(Ts min)	150°C
-Temperature Max(Ts max)	200°C
-Time(Ts min to Ts max)	60~180 seconds
Time maintained above:	
-Temperature(TL)	217°C
-Time(tL)	60~150 seconds
Peak Temperature(Tp)	260°C
Ramp-Down Rate	6°C/second max.
Time 25°C to Peak Temperature	8 minutes max
Storage Condition	0°C~35°C, ≤70%RH

Physical Dimensions(mm.)

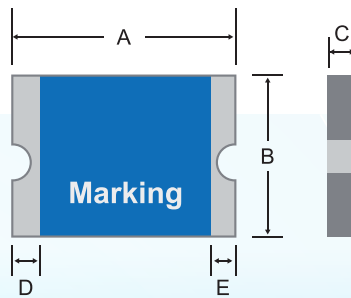

Model	A		B		C		D	E
	Min.	Max.	Min.	Max.	Min.	Max.	Min.	Min.
ASMD1206-005	3.0	3.6	1.5	1.9	0.6	1.2	0.15	0.1
ASMD1206-010	3.0	3.6	1.5	1.9	0.6	1.2	0.15	0.1
ASMD1206-012	3.0	3.6	1.5	1.9	0.6	1.2	0.15	0.1
ASMD1206-016	3.0	3.6	1.5	1.9	0.4	1.0	0.15	0.1
ASMD1206-020	3.0	3.6	1.5	1.9	0.4	1.0	0.15	0.1
ASMD1206-020-30V	3.0	3.6	1.5	1.9	0.4	1.0	0.15	0.1
ASMD1206-020-48V	3.0	3.6	1.5	1.9	0.4	1.0	0.15	0.1
ASMD1206-025	3.0	3.6	1.5	1.9	0.4	1.0	0.15	0.1
ASMD1206-025-30V	3.0	3.6	1.5	1.9	0.4	1.0	0.15	0.1
ASMD1206-025-48V	3.0	3.6	1.5	1.9	0.4	1.0	0.15	0.1
ASMD1206-035	3.0	3.6	1.5	1.9	0.35	0.8	0.15	0.1
ASMD1206-035-16V	3.0	3.6	1.5	1.9	0.35	0.8	0.15	0.1
ASMD1206-035-30V	3.0	3.6	1.5	1.9	0.4	0.9	0.15	0.1
ASMD1206-050	3.0	3.6	1.5	1.9	0.35	0.8	0.15	0.1
ASMD1206-050-13.2V	3.0	3.6	1.5	1.9	0.35	0.8	0.15	0.1
ASMD1206-050-16V	3.0	3.6	1.5	1.9	0.35	0.8	0.15	0.1
ASMD1206-050-30V	3.0	3.6	1.5	1.9	0.5	1.0	0.15	0.1
ASMD1206-075	3.0	3.6	1.5	1.9	0.35	0.8	0.15	0.1
ASMD1206-075-16V	3.0	3.6	1.5	1.9	0.5	1.0	0.15	0.1
ASMD1206-075-30V	3.0	3.6	1.5	1.9	0.5	1.0	0.15	0.1
ASMD1206-100	3.0	3.6	1.5	1.9	0.35	0.8	0.15	0.1
ASMD1206-100-16V	3.0	3.6	1.5	1.9	0.5	1.0	0.15	0.1
ASMD1206-100-24V	3.0	3.6	1.5	1.9	0.5	1.0	0.15	0.1
ASMD1206-110	3.0	3.6	1.5	1.9	0.35	0.8	0.15	0.1
ASMD1206-110-16V	3.0	3.6	1.5	1.9	0.5	1.0	0.15	0.1
ASMD1206-110-24V	3.0	3.6	1.5	1.9	0.5	1.0	0.15	0.1
ASMD1206-150	3.0	3.6	1.5	1.9	0.5	1.0	0.15	0.1
ASMD1206-150-13.2V	3.0	3.6	1.5	1.9	1.0	1.6	0.15	0.1
ASMD1206-200	3.0	3.6	1.5	1.9	0.7	1.6	0.15	0.1
ASMD1206-200-12V	3.0	3.6	1.5	1.9	0.7	1.6	0.15	0.1
ASMD1206-200-16V	3.0	3.6	1.5	1.9	0.7	1.6	0.15	0.1
ASMD1206-260	3.0	3.6	1.5	1.9	1.0	1.6	0.15	0.1
ASMD1206-300	3.0	3.6	1.5	1.9	1.0	1.6	0.15	0.1
ASMD1206-350	3.0	3.5	1.5	1.9	1.0	1.6	0.15	0.1

Termination Pad Characteristics

Terminal pad materials: Tin-plated Nickel-Copper

Terminal pad solder ability: Meets EIA specification RS186-9E and ANSI/J-STD-002 Category 3

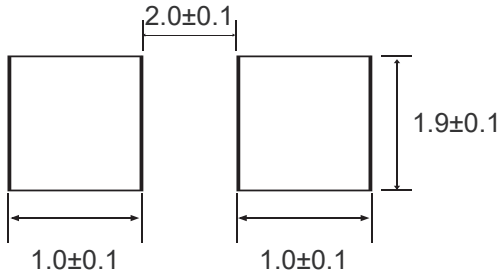
Packaging Quantity and Marking

Part Number	Quantity
ASMD1206	3500 pcs/reel
Tape & reel packaging per EIA481-1	

Tape And Reel Specifications (mm)

Governing Specifications	EIA 481-1
W	8.15 ± 0.3
P0	4.0 ± 0.10
P1	4.0 ± 0.10
P2	2.0 ± 0.05
A0	1.95 ± 0.10
B0	3.40 ± 0.10
B1max.	4.35
D0	1.50 + 0.1, -0
F	3.5 ± 0.05
E1	1.75 ± 0.10
E2min.	6.25
T	0.6
T1max.	0.1
K0	1.04 ± 0.1
Leader min.	390
Trailer min.	160
Reel Dimensions	
A max.	178
N min.	60
W1	9 ± 0.5
W2	12.6 ± 0.5

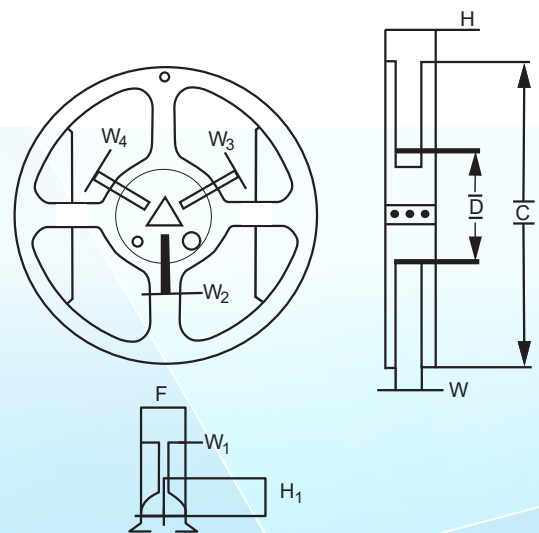
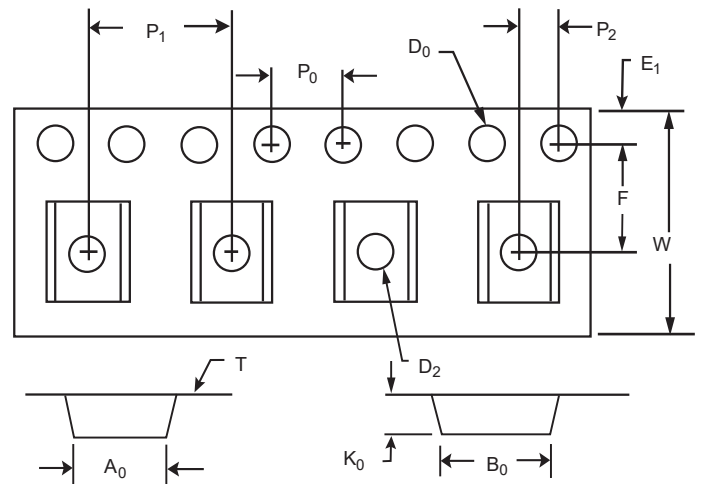
Storage And Handling

- Storage conditions: 40°C max, 70% R.H.
- Devices may not meet specified performance if storage conditions are exceeded. Technology Corp.

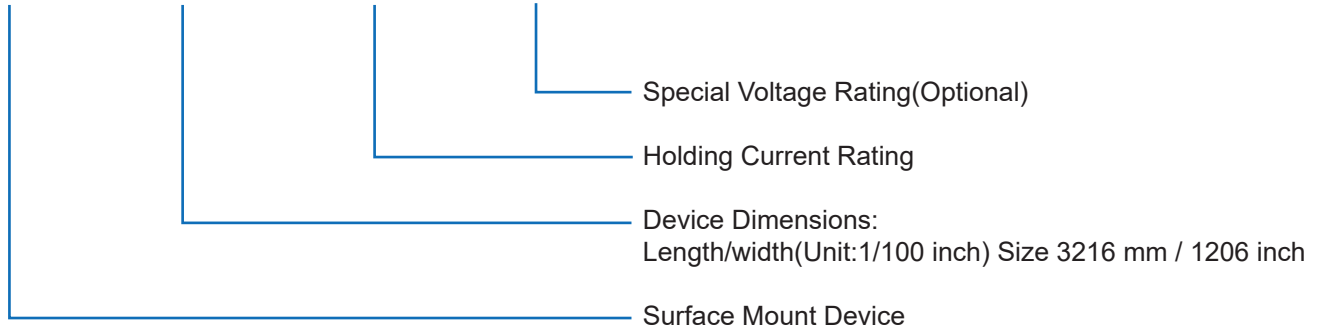
Part Number System
ASMD 1206 - □□□ - □□

Cross Reference

Model	Cross Reference		
	Tyco / PolySwitch®	Littelfuse / POLY-FUSE®	Polytronics / EVERFUSE®
ASMD1206-005	-	-	-
ASMD1206-010	-	-	-
ASMD1206-012	nanoSMDC012F	1206L012	SMD1206P012TF
ASMD1206-020	nanoSMDC020F	1206L020	SMD1206P020TF/24
ASMD1206-025	-	1206L025	SMD1206P025TF
ASMD1206-035	nanoSMDC035F	1206L035	-SMD1206P035TF
ASMD1206-050	nanoSMDC050F	1206L050	SMD1206P050TF
ASMD1206-050-13.2V	nanoSMDC050F/13.2	1206L050/15	SMD1206P050TF/15
ASMD1206-075	nanoSMDC075F	1206L075	SMD1206P075TF
ASMD1206-075-16V	nanoSMDC075F/16	1206L075/16	SMD1206P075TF/16
ASMD1206-100	-	-	-
ASMD1206-110	nanoSMDC110F	1206L110	SMD1206P110TF
ASMD1206-150	nanoSMDC150F	1206L150	SMD1206P150TF
ASMD1206-200	nanoSMDC200F	1206L200	SMD1206P200TF

“PolySwitch” is a registered trademark of Tyco Electronics.

“POLY-FUSE” is a registered trademark of Littelfuse, Inc.

“EVERFUSE” is a registered trademark of Polytronics Technology Corp.