

# 1N4148WS-HAF

## Silicon Epitaxial Planar Switching Diode

### Features

- SC-76 package
- Fast switching
- These diodes are also available in other case style including the DO-35 case with the type designation 1N4148, the MiniMELF case with the type designation LL4148 and the MicroMELF case with the type designation MCL4148.
- Halogen and Antimony Free(HAF), RoHS compliant

### PINNING

PIN	DESCRIPTION
1	Cathode
2	Anode

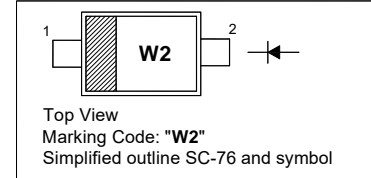

### Absolute Maximum Ratings ( $T_a = 25\text{ }^\circ\text{C}$ )

Parameter	Symbol	Value	Unit
Peak Reverse Voltage	$V_{RM}$	100	V
Reverse Voltage	$V_R$	75	V
Average Rectified Forward Current	$I_{F(AV)}$	150	mA
Surge Forward Current	$I_{FSM}$	2 1	A
			at $t < 1\text{ }\mu\text{s}$ at $t < 1\text{ s}$
Power Dissipation	$P_{tot}$	200	mW
Thermal Resistance from Junction to Ambient Air	$R_{\theta JA}$	625	$^\circ\text{C/W}$
Junction Temperature	$T_j$	150	$^\circ\text{C}$
Storage Temperature Range	$T_{stg}$	- 65 to + 150	$^\circ\text{C}$

### Characteristics at $T_a = 25\text{ }^\circ\text{C}$

Parameter	Symbol	Min.	Max.	Unit
Reverse Breakdown Voltage at $I_R = 1\text{ }\mu\text{A}$	$V_{(BR)R}$	75	-	V
Forward Voltage at $I_F = 1\text{ mA}$ at $I_F = 10\text{ mA}$ at $I_F = 50\text{ mA}$ at $I_F = 150\text{ mA}$	$V_F$	- - - -	0.715 0.855 1 1.25	V
Peak Reverse Current at $V_R = 75\text{ V}$ at $V_R = 20\text{ V}$ at $V_R = 75\text{ V}, T_J = 150\text{ }^\circ\text{C}$ at $V_R = 25\text{ V}, T_J = 150\text{ }^\circ\text{C}$	$I_R$	- - - -	1 25 50 30	$\mu\text{A}$ nA $\mu\text{A}$ $\mu\text{A}$
Total Capacitance at $V_R = 0\text{ V}, f = 1\text{ MHz}$	$C_T$	-	2	pF
Reverse Recovery Time at $I_{rr} = 0.1 \times I_R, I_F = 10\text{ mA}, V_R = 6\text{ V}, R_L = 100\text{ }\Omega$	$t_{rr}$	-	4	ns

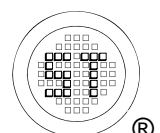

# 1N4148WS-HAF

## Electrical Characteristics Curves

Fig 1. Power Dissipation vs Ambient Temperature

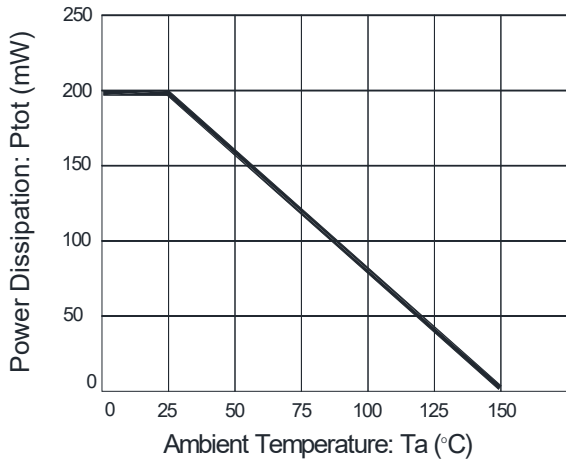

Fig 2. Total Capacitance vs. Reverse Voltage

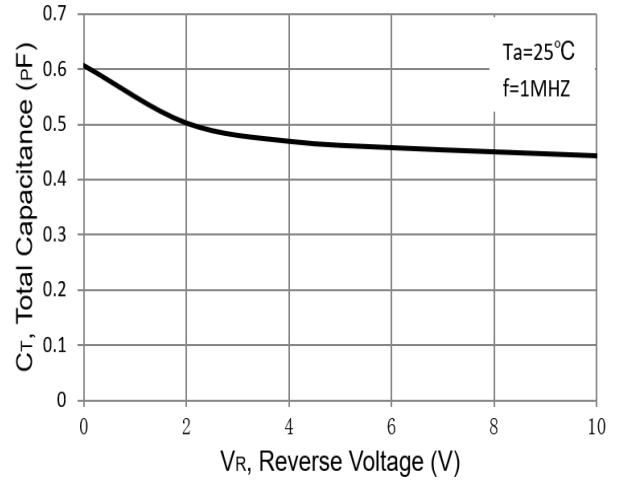

Fig 3. Reverse Current vs. Reverse Voltage

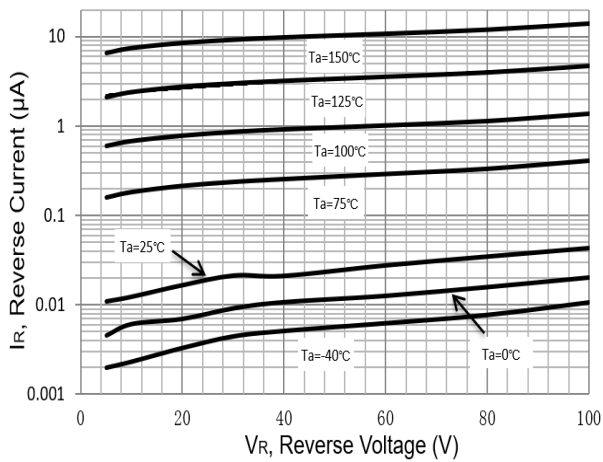
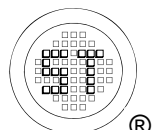
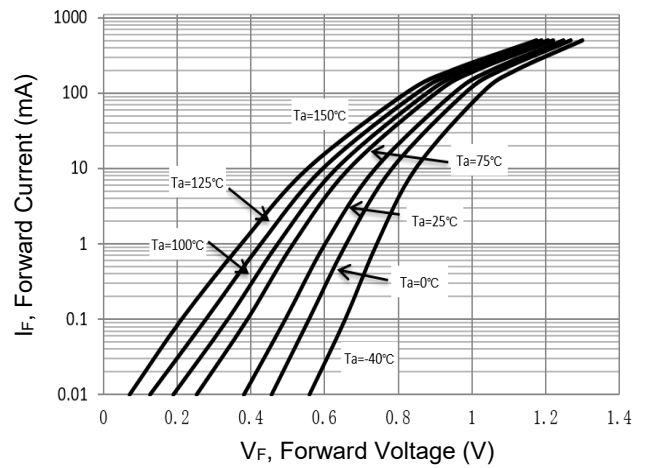

Fig 4. Forward Characteristics



# 1N4148WS-HAF

## PACKAGE OUTLINE

Plastic surface mounted package; 2 leads

SC-76

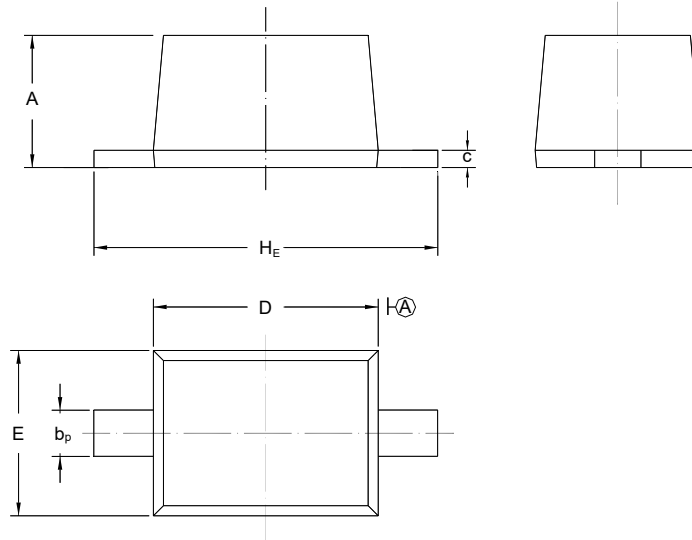

UNIT	A	b <sub>p</sub>	C	D	E	H <sub>E</sub>
mm	1.10 0.80	0.40 0.25	0.15 0.10	1.80 1.60	1.35 1.15	2.80 2.30

## Recommended Soldering Footprint

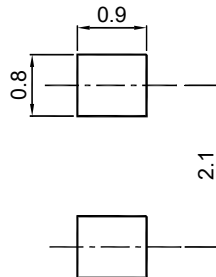

## Packing information

Package	Tape Width (mm)	Pitch		Reel Size		Per Reel Packing Quantity
		mm	inch	mm	inch	
SC-76	8	4 ± 0.1	0.157 ± 0.004	178	7	3,000

## Marking information

" • " = HAF (Halogen and Antimony Free)  
 " W2 " = Part No  
 " III " = Cathode line  
 Font type: Arial

