

Features

- N-Channel
20V/10A,
 $R_{DS(ON)} = 12m\Omega$ (Typ.) @ $V_{GS} = 4.5V$
 $R_{DS(ON)} = 15m\Omega$ (Typ.) @ $V_{GS} = 2.5V$
- P-Channel
-20V/-10A,
 $R_{DS(ON)} = 20m\Omega$ (Typ.) @ $V_{GS} = -4.5V$
 $R_{DS(ON)} = 30m\Omega$ (Typ.) @ $V_{GS} = -2.5V$
- Reliable and Rugged
- Lead Free and Green Devices Available (RoHS Compliant)

Applications

- Load Switch

Pin Description

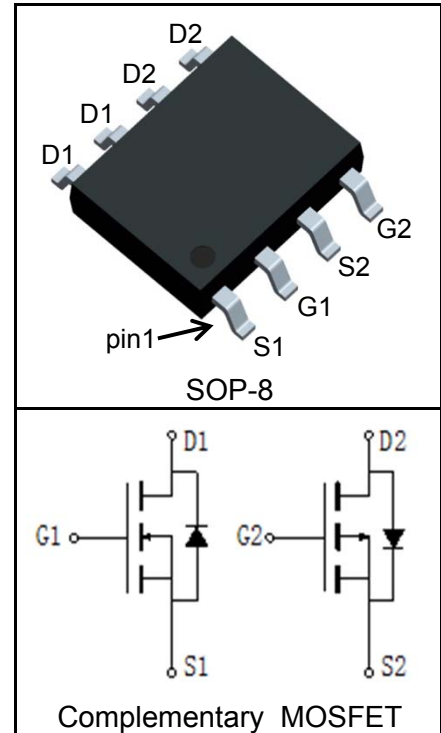

Absolute Maximum Ratings

Symbol	Parameter		N-Channel	P-Channel	Unit
Common Ratings ($T_A = 25^\circ C$ Unless Otherwise Noted)					
V_{DSS}	Drain-Source Voltage		20	-20	V
V_{GSS}	Gate-Source Voltage		± 12	± 12	
T_J	Maximum Junction Temperature		150	150	$^\circ C$
T_{STG}	Storage Temperature Range		-55 to 150	-55 to 150	$^\circ C$
I_S	Diode Continuous Forward Current	$T_A = 25^\circ C$	1	1	A
Mounted on Large Heat Sink					
$I_{DP}^{①}$	300 μs Pulse Drain Current Tested	$T_A = 25^\circ C$	40	40	A
$I_D^{②}$	Continuous Drain Current ($V_{GS} = \pm 10V$)	$T_A = 25^\circ C$	10	-10	A
		$T_A = 70^\circ C$	5	-5	
P_D	Maximum Power Dissipation	$T_A = 25^\circ C$	1.25	1.25	W
		$T_A = 70^\circ C$	0.75	0.75	
$R_{\theta JC}$	Thermal Resistance-Junction to Case		TBD	TBD	$^\circ C/W$
$R_{\theta JA}^{③}$	Thermal Resistance-Junction to Ambient		62.5	62.5	$^\circ C/W$
Drain-Source Avalanche Ratings					
$E_{AS}^{④}$	Avalanche Energy, Single Pulsed		TBD	TBD	mJ

Electrical Characteristics ($T_A=25^\circ\text{C}$ Unless Otherwise Noted)

Symbol	Parameter	Test Condition	RU20C10H			Unit	
			Min.	Typ.	Max.		
Static Characteristics							
BV_{DSS}	Drain-Source Breakdown Voltage	$V_{GS}=0V, I_{DS}=250\mu A$	N	20		V	
		$V_{GS}=0V, I_{DS}=-250\mu A$	P	-20			
I_{DSS}	Zero Gate Voltage Drain Current	$V_{DS}=20V, V_{GS}=0V$	N		1	μA	
		$T_J=125^\circ C$			30		
		$V_{DS}=-20V, V_{GS}=0V$	P		-1		
		$T_J=125^\circ C$			-30		
$V_{GS(th)}$	Gate Threshold Voltage	$V_{DS}=V_{GS}, I_{DS}=250\mu A$	N	0.5	0.7	1.1	V
		$V_{DS}=V_{GS}, I_{DS}=-250\mu A$	P	-0.4	0.7	-1.1	
I_{GSS}	Gate Leakage Current	$V_{GS}=\pm 12V, V_{DS}=0V$	N			± 10	μA
		$V_{GS}=\pm 12V, V_{DS}=0V$	P			± 10	
$R_{DS(ON)}^{(5)}$	Drain-Source On-state Resistance	$V_{GS}=4.5V, I_{DS}=5A$	N		12	14	m Ω
		$V_{GS}=-4.5V, I_{DS}=-5A$	P		20	25	
		$V_{GS}=2.5V, I_{DS}=4A$	N		15	18	
		$V_{GS}=-2.5V, I_{DS}=-4A$	P		30	35	
Diode Characteristics							
$V_{SD}^{(5)}$	Diode Forward Voltage	$I_{SD}=5A, V_{GS}=0V$	N			1.2	V
		$I_{SD}=-5A, V_{GS}=0V$	P			-1.2	
t_{rr}	Reverse Recovery Time	N-Channel $I_{SD}=10A, dI_{SD}/dt=100A/\mu s$	N		15	ns	
			P		17		
Q_{rr}	Reverse Recovery Charge	P-Channel $I_{SD}=-10A, dI_{SD}/dt=100A/\mu s$	N		8	nC	
			P		23		
Dynamic Characteristics ⁽⁶⁾							
R_G	Gate Resistance	$V_{GS}=0V, V_{DS}=0V, F=1MHz$	N		1.5	Ω	
			P		1.3		
C_{iss}	Input Capacitance	N-Channel $V_{GS}=0V, V_{DS}=10V,$ Frequency=1.0MHz	N		590	pF	
			P		640		
C_{oss}	Output Capacitance	P-Channel $V_{GS}=0V, V_{DS}=-10V,$ Frequency=1.0MHz	N		125		
			P		135		
C_{rss}	Reverse Transfer Capacitance	Frequency=1.0MHz	N		90		
			P		85		

Electrical Characteristics ($T_A=25^{\circ}\text{C}$ Unless Otherwise Noted)

Symbol	Parameter	Test Condition	RU20C10H			Unit	
			Min.	Typ.	Max.		
Dynamic Characteristics ^⑥							
$t_{d(ON)}$	Turn-on Delay Time	N-Channel $V_{DD}=10\text{V}, I_{DS}=10\text{A},$ $V_{GEN}=4.5\text{V}, R_G=4.7\Omega$ P-Channel $V_{DD}=-10\text{V}, I_{DS}=-10\text{A},$ $V_{GEN}= -4.5\text{V}, R_G=4.7\Omega$	N		8		ns
			P		9		
t_r	Turn-on Rise Time		N		15		
			P		15		
$t_{d(OFF)}$	Turn-off Delay Time		N		33		
			P		34		
t_f	Turn-off Fall Time		N		13		
			P		15		
Gate Charge Characteristics ^⑥							
Q_g	Total Gate Charge	N-Channel $V_{DS}=16\text{V}, V_{GS}=4.5\text{V},$ $I_{DS}=10\text{A}$ P-Channel $V_{DS}=-16\text{V}, V_{GS}= -4.5\text{V},$ $I_{DS}=-10\text{A}$	N		10		nC
			P		10		
Q_{gs}	Gate-Source Charge		N		1.4		
			P		2		
Q_{gd}	Gate-Drain Charge		N		3.6		
			P		3		

- Notes:
- ① Pulse width limited by safe operating area.
 - ② Calculated continuous current based on maximum allowable junction temperature.
 - ③ When mounted on 1 inch square copper board, $t \leq 10\text{sec}$. The value in any given application depends on the user's specific board design.
 - ④ Limited by T_{Jmax} . Starting $T_J = 25^{\circ}\text{C}$.
 - ⑤ Pulse test; Pulse width $\leq 300\mu\text{s}$, duty cycle $\leq 2\%$.
 - ⑥ Guaranteed by design, not subject to production testing.

Ordering and Marking Information

Device	Marking	Package	Packaging	Quantity	Reel Size	Tape width
RU20C10H	RU20C10H	SOP-8	Tape&Reel	2500	13"	12mm

Typical Characteristics(N-Channel)

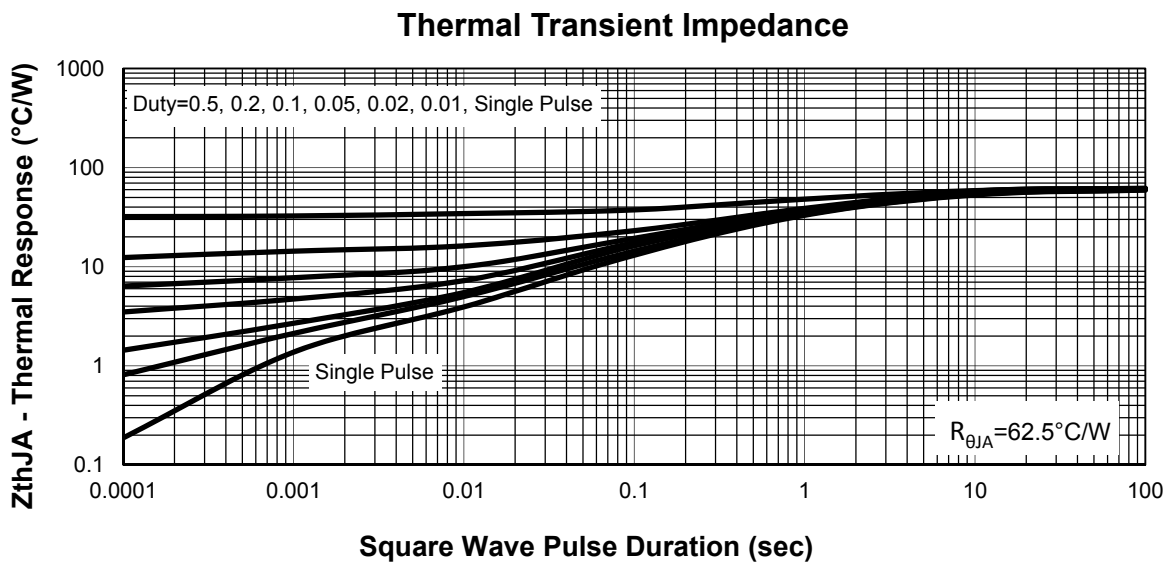
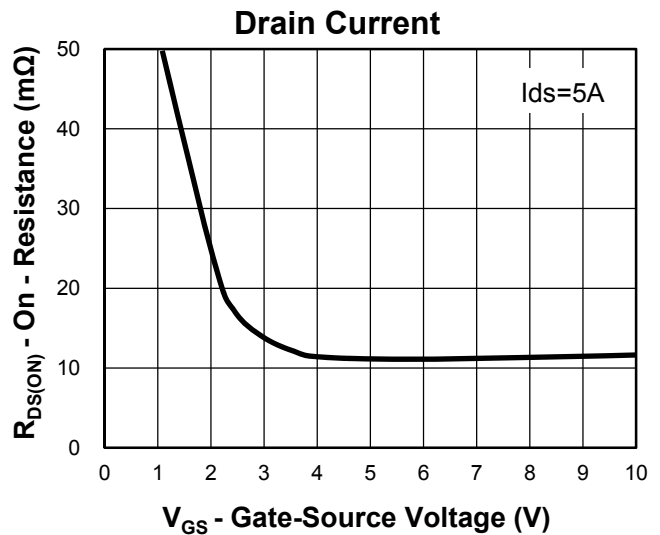
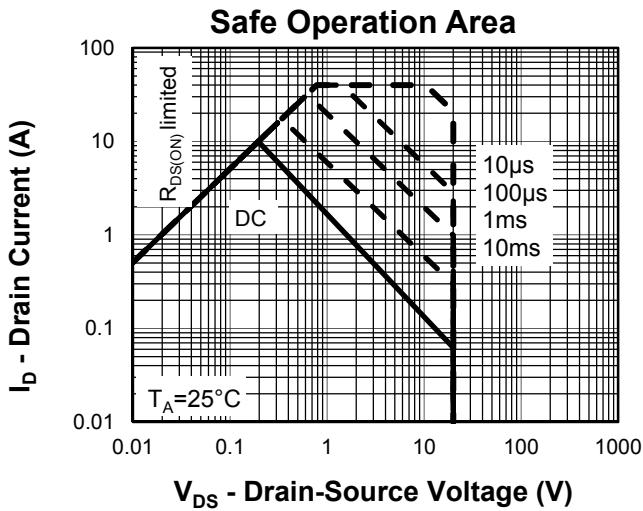
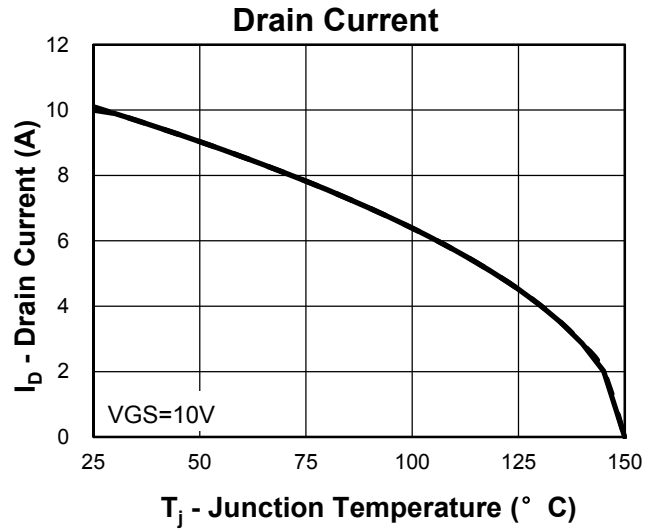
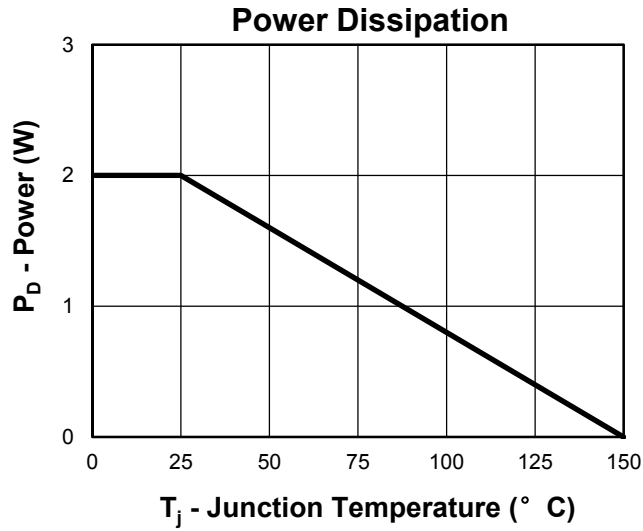

Typical Characteristics(N-Channel)

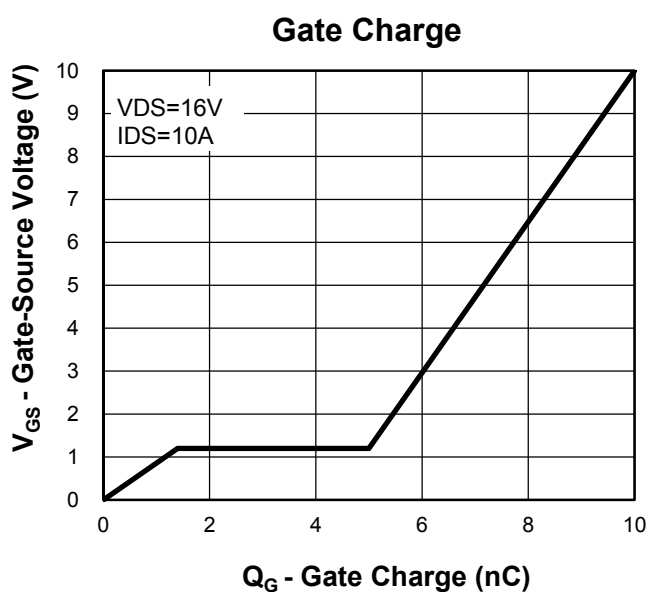
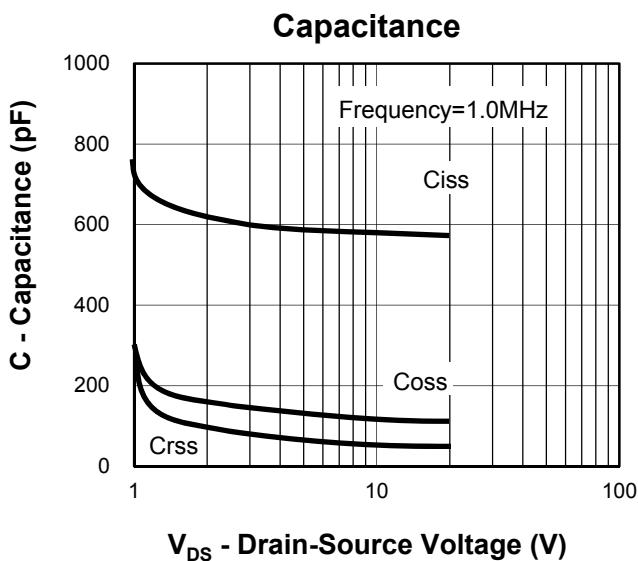
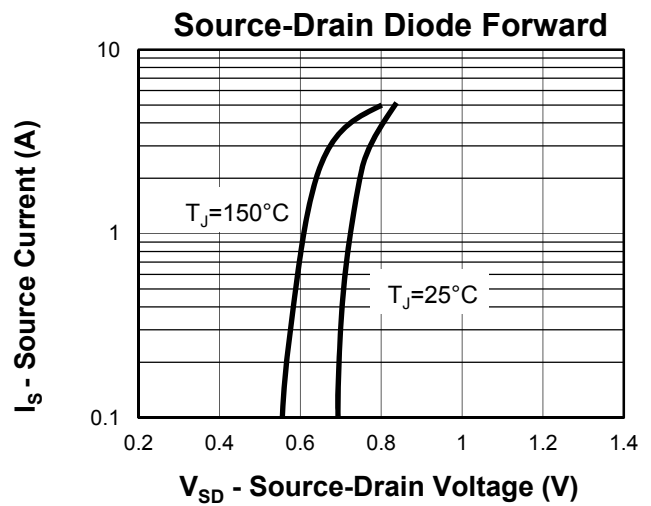
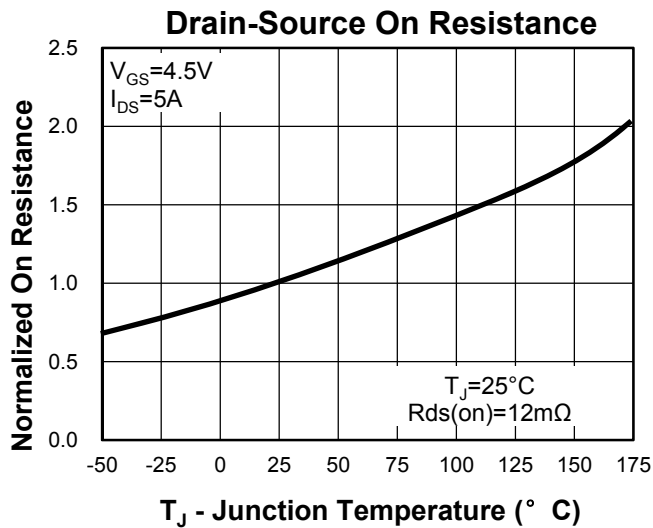
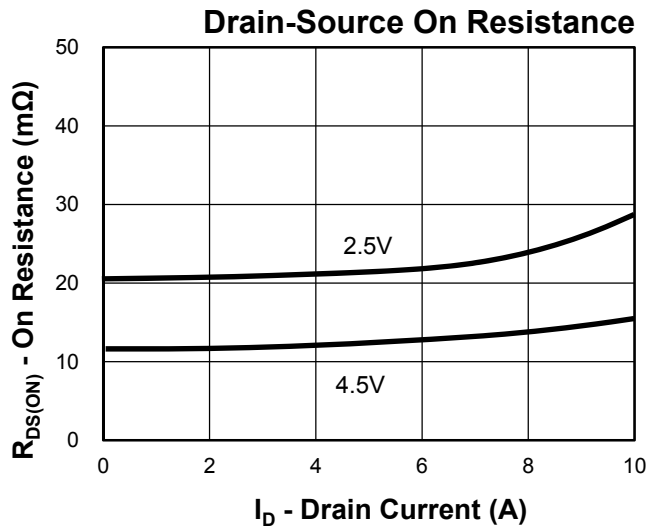
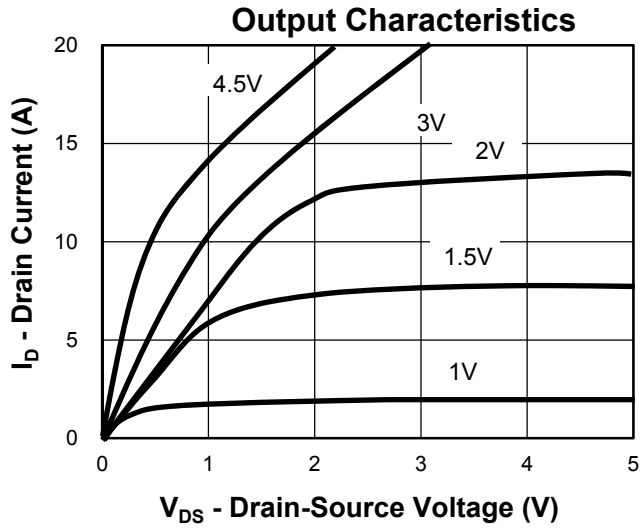

Typical Characteristics(P-Channel)

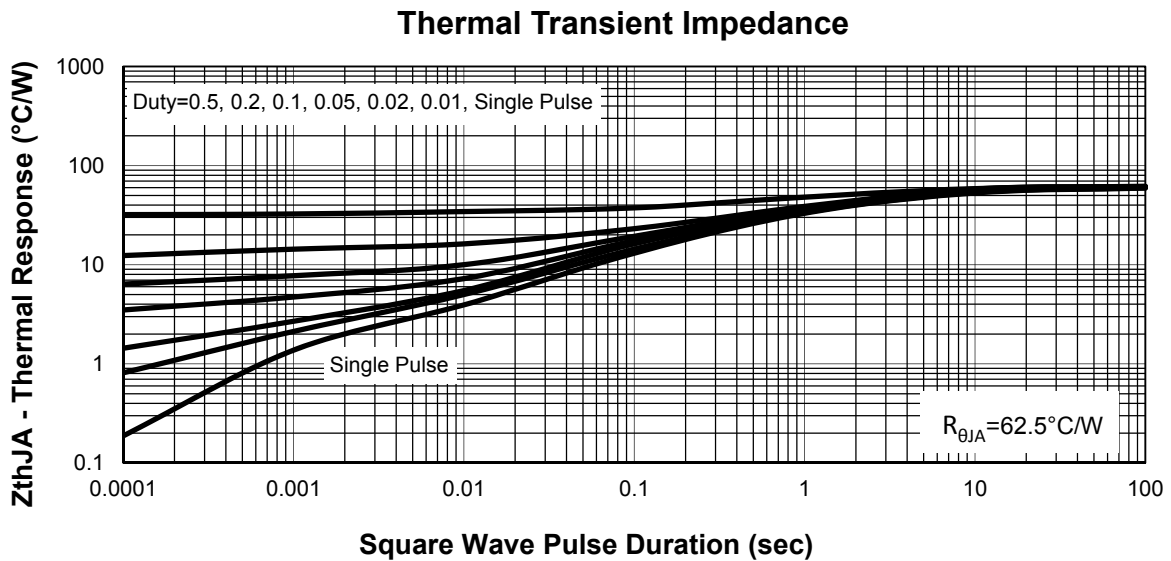
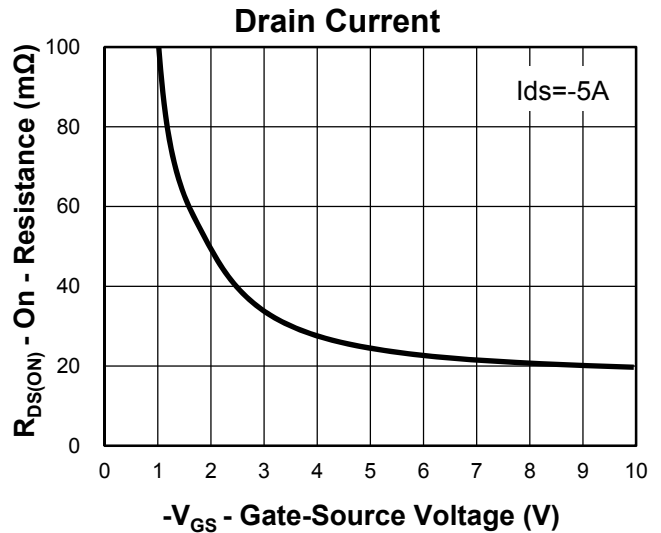
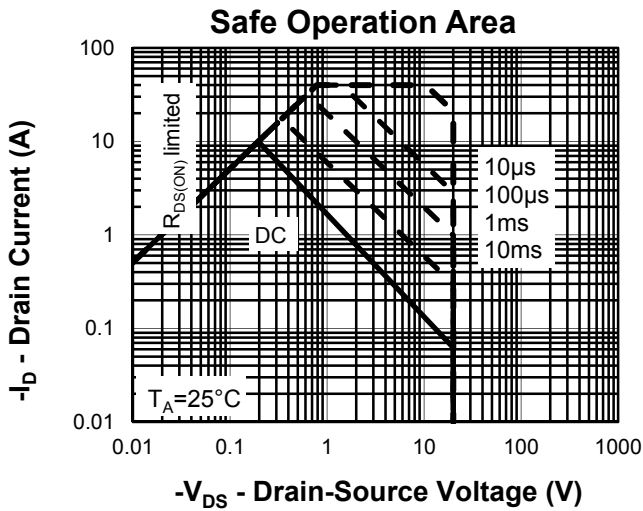
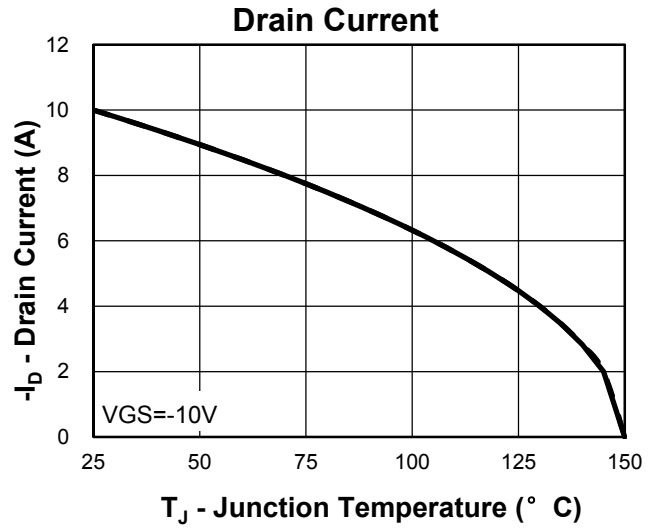
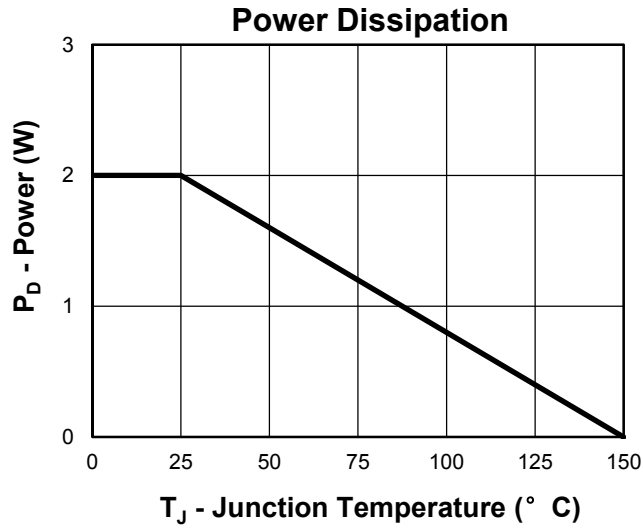

Typical Characteristics(P-Channel)

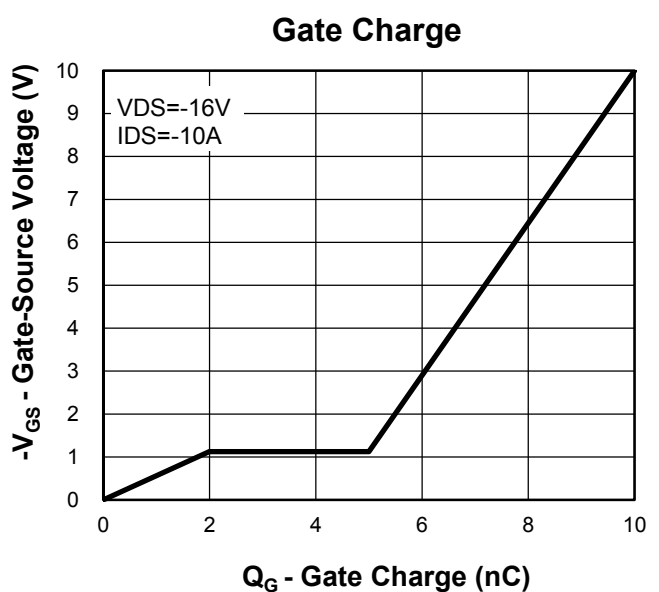
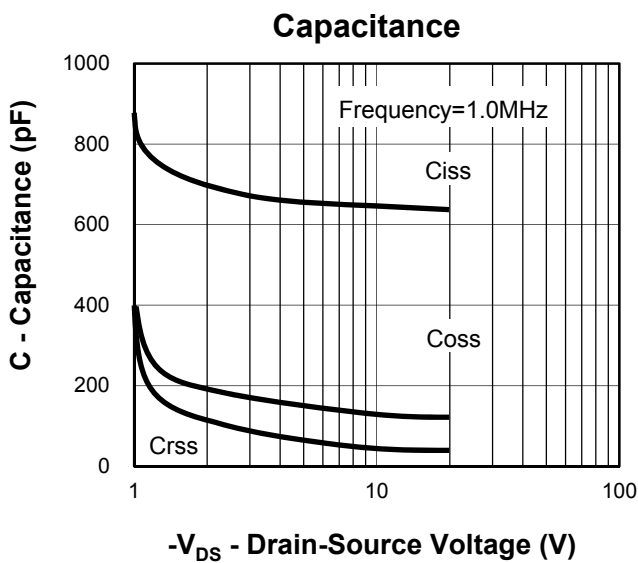
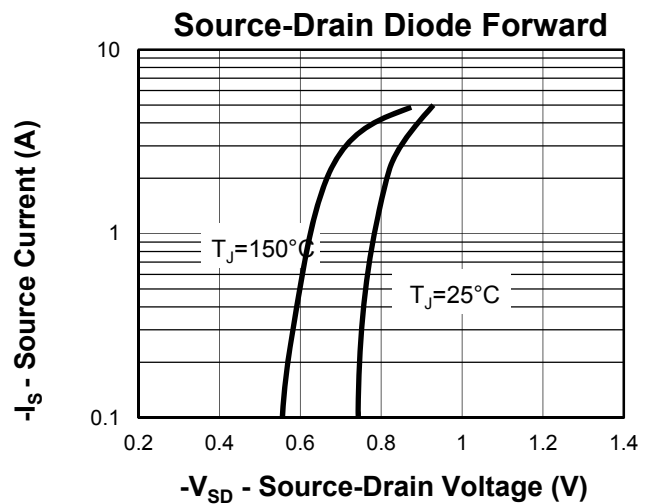
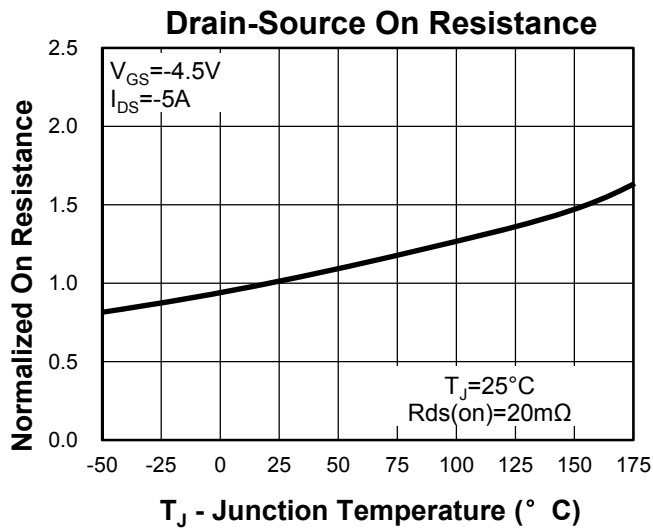
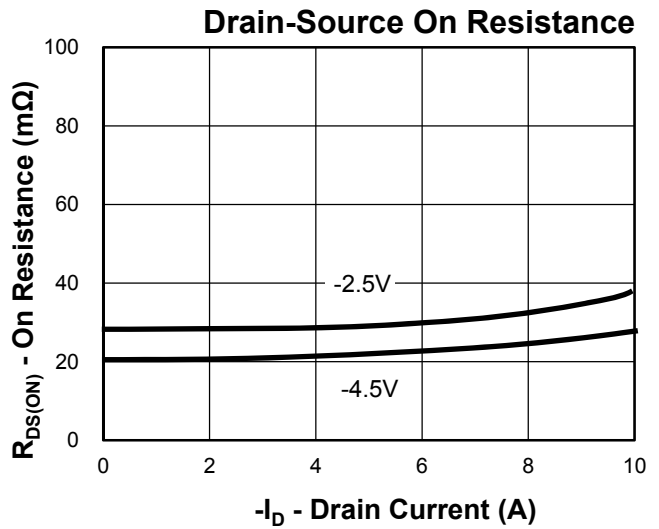
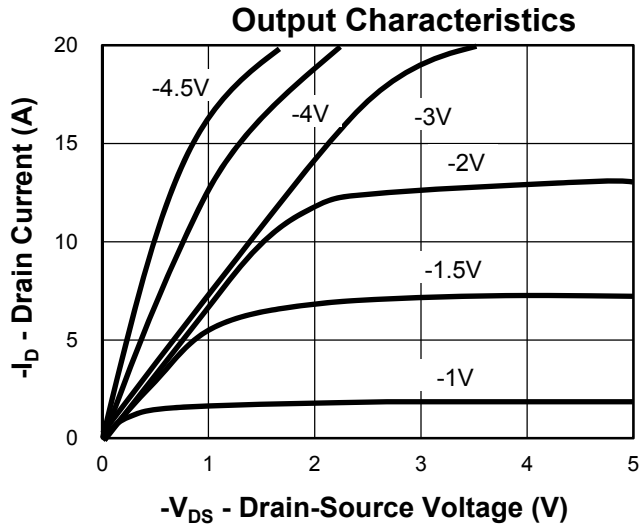

Package Information

SOP-8

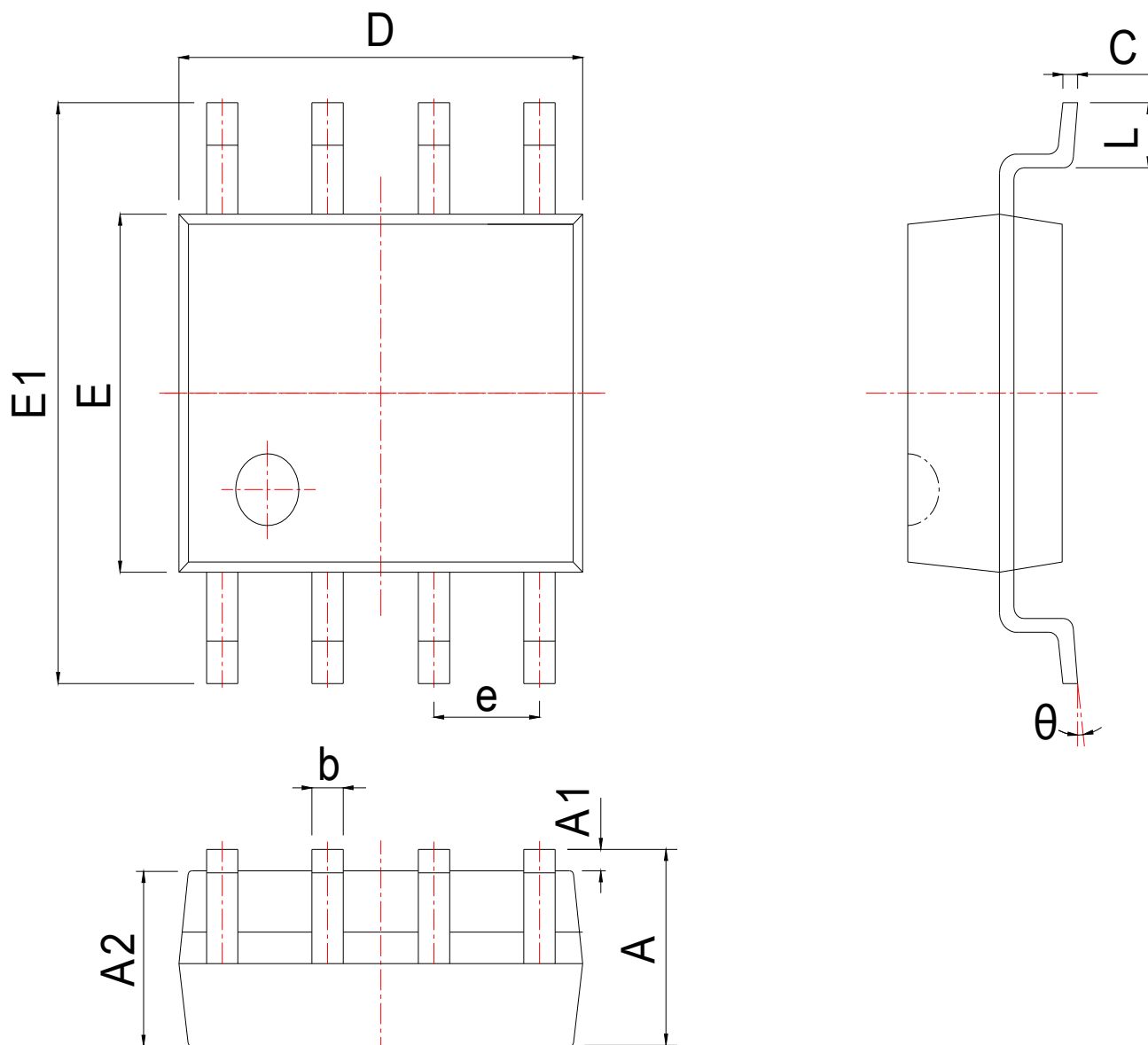

SYMBOL	MM			INCH		
	MIN	NOM	MAX	MIN	NOM	MAX
A	1.300	1.525	1.750	0.051	0.060	0.069
A1	0.050	0.150	0.250	0.002	0.006	0.010
A2	1.350	1.450	1.550	0.053	0.057	0.061
b	0.330	0.420	0.510	0.013	0.017	0.020
c	0.170	0.210	0.250	0.007	0.008	0.010
D	4.700	4.900	5.100	0.185	0.193	0.201
E	3.800	3.900	4.000	0.150	0.154	0.157
E1	5.800	6.000	6.200	0.228	0.236	0.244
e	1.270 BSC			0.050 BSC		
L	0.400	0.835	1.270	0.016	0.033	0.050
θ	0°		8°	0°		8°

Customer Service**Worldwide Sales and Service:**

Sales@ruichips.com

Technical Support:

Technical@ruichips.com

Investor Relations Contacts:

Investor@ruichips.com

Marcom Contact:

Marcom@ruichips.com

Editorial Contact:

Editorial@ruichips.com

HR Contact:

HR@ruichips.com

Legal Contact:

Legal@ruichips.com

Shen Zhen RUICHIPS Semiconductor CO., LTD

4th Floor, Block 8, Changyuan New Material Port, Keyuan Middle Road, Science & Industry Park,
Nanshan District, Shenzhen, CHINA

TEL: (86-755) 8311-5334

FAX: (86-755) 8311-4278

E-mail: Sales-SZ@ruichips.com