

MULTI-LAYER HIGH-Q CAPACITORS

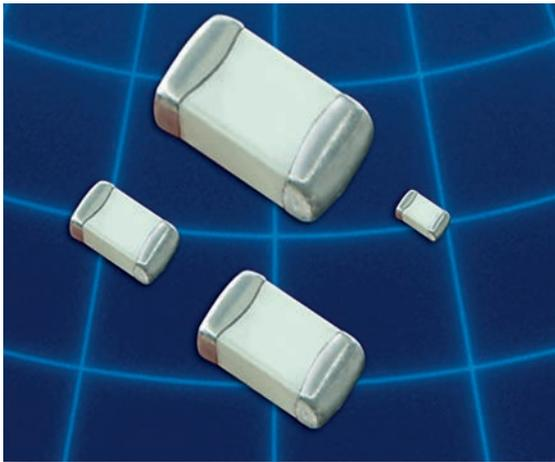

These lines of multilayer capacitors have been developed for High-Q and microwave applications.

- The **S-Series** (R03S, R07S, R14S, R15S) capacitors give an ultra-high Q performance, and exhibit NP0 temperature characteristics.
- The **L-Series** (R05L) capacitors give mid-high Q performance, and exhibit NP0 temperature characteristics.
- The **E-Series** (S42E, S48E, S58E) capacitors give excellent high-Q performance from HF to Microwave frequencies. Typical uses are high voltage, high current applications. They are offered in chip (Ni barrier or Non-Magnetic Pt.-Ag) or in Non-Magnetic leaded form.
- The **W-Series** (R05W) capacitors offer a large capacitance value in an ultra-small 0201 package size. These exhibit a X7R temperature characteristic.
- RoHS compliance is standard for all unleaded parts (see termination options box).

HOW TO ORDER

252	S48	E	470	K	V	4	E
VOLTAGE (DC) 6R3 = 6.3 V 101 = 100 V 160 = 16 V 250 = 25 V 500 = 50 V 201 = 200 V 251 = 250 V 301 = 300 V 501 = 500 V 102 = 1000 V 152 = 1500 V 202 = 2000 V 252 = 2500 V 362 = 3600 V 502 = 5000 V 722 = 7200 V	CASE SIZE R03 (01005) R05 (0201) R07 (0402) R14 (0603) R15 (0805) S42 (1111) S48 (2525) S58 (3838)	CAPACITANCE (pF) 1st two digits are significant; third digit denotes number of zeros, R = decimal. 100 = 10 pF 101 = 100 pF	DIELECTRIC S = Ultra High Q NPO L = High Q NPO E = Ultra High Q NPO, High Voltage, High Power, *T = High Temp (175C) Ultra High Q NPO W = X7R	TOLERANCE A = ± 0.05 pF B = ± 0.10 pF C = ± 0.25 pF D = ± 0.50 pF F = ± 1 % G = ± 2 % J = ± 5 % K = ± 10 % For tolerance availability, see chart.	TERMINATION Nickel Barrier V = Ni/Sn (Green) T = Ni/SnPb G = Ni/Au (Green) Non-Mag* U = Cu/Sn (Green) C = Cu/SnPb Leaded (All Non-Mag)* 1 = Microstrip 2 = Axial Ribbon 3 = Axial Wire 4 = Radial Ribbon 5 = Radial Wire	PACKAGING S = Bulk W = Waffle Pack 01005 - 0603 Y = Paper 5" Reel T = Paper 7" Reel *R = Paper 13" Reel *J = Paper 5" Reel - Horizontally Oriented Electrodes *N = Paper 5" Reel - Vertically Oriented Electrodes *L = Paper 7" Reel - Horizontally Oriented Electrodes *V = Paper 7" Reel - Vertically Oriented Electrodes 0805 - 3838 Z = Embossed 5" Reel E = Embossed 7" Reel *U = Embossed 13" Reel *M = Embossed 5" Reel - Horizontally Oriented Electrodes *Q = Embossed 5" Reel - Vertically Oriented Electrodes *G = Embossed 7" Reel - Horizontally Oriented Electrodes *P = Embossed 7" Reel - Vertically Oriented Electrodes Tape specifications conform to EIA RS481	
Part Number written: 252S48E470KV4E						MARKING 3 = Cap Code & Tolerance 4 = No Marking 6 = EIA Code (Marking on 0805 and larger only)	



** - Not available for all MLCC - Call factory for info.

LOW ESR / HIGH-Q CAPACITOR SELECTION CHART

EIA Size		Miniature Size - Portable Electronics				RF Power Applications							
		01005 (R03S)	0201 (R05)		0402 (R07S)	0603 (R14S)	0805 (R15S)	0805 (R15E)	1111 (S42E)	2525 (S48E)	3838 (S58E)		
NPO (R05L)	X7R* (R05W)												
Cap. Value	Code	Voltage											
0.1	0R1												
0.2	0R2	16 V	25 V	50/200 V	250 V			500V	1000V				
0.3	0R3	16 V	25 V	50/200 V	250 V	250 V	500V	500V	1000V				
0.4	0R4	16 V	25 V	50/200 V	250 V	250 V	500V	500V	1000V				
0.5	0R5	16 V	25 V	50/200 V	250 V	250 V	500V	500V	1000V	2500V			
0.6	0R6	16 V	25 V	50/200 V	250 V	250 V	500V	500V	1000V	2500V	3600V	7200V	
0.7	0R7	16 V	25 V	50/200 V	250 V	250 V	500V	500V	1000V	2500V	3600V	7200V	
0.8	0R8	16 V	25 V	50/200 V	250 V	250 V	500V	500V	1000V	2500V	3600V	7200V	
0.9	0R9	16 V	25 V	50/200 V	250 V	250 V	500V	500V	1000V	2500V	3600V	7200V	
1.0	1R0	16 V	25 V	50/200 V	250 V	250 V	500V	500V	1000V	2500V	3600V	7200V	
1.1	1R1	16 V	25 V	50/200 V	250 V	250 V	500V	500V	1000V	2500V	3600V	7200V	
1.2	1R2	16 V	25 V	50/200 V	250 V	250 V	500V	500V	1000V	2500V	3600V	7200V	
1.3	1R3	16 V	25 V	50/200 V	250 V	250 V	500V	500V	1000V	2500V	3600V	7200V	
1.4	1R4	16 V	25 V	50/200 V	250 V	250 V	500V	500V	1000V	2500V	3600V	7200V	
1.5	1R5	16 V	25 V	50/200 V	250 V	250 V	500V	500V	1000V	2500V	3600V	7200V	
1.6	1R6	16 V	25 V	50/200 V	250 V	250 V	500V	500V	1000V	2500V	3600V	7200V	
1.7	1R7	16 V	25 V	50/200 V	250 V	250 V	500V	500V	1000V	2500V	3600V	7200V	
1.8	1R8	16 V	25 V	50/200 V	250 V	250 V	500V	500V	1000V	2500V	3600V	7200V	
1.9	1R9	16 V	25 V	50/200 V	250 V	250 V	500V	500V	1000V	2500V	3600V	7200V	
2.0	2R0	16 V	25 V	50/200 V	250 V	250 V	500V	500V	1000V	2500V	3600V	7200V	
2.1	2R1	16 V	25 V	50/200 V	250 V	250 V	500V	500V	1000V	2500V	3600V	7200V	
2.2	2R2	16 V	25 V	50/200 V	250 V	250 V	500V	500V	1000V	2500V	3600V	7200V	
2.4	2R4	16 V	25 V	50/200 V	250 V	250 V	500V	500V	1000V	2500V	3600V	7200V	
2.7	2R7	16 V	25 V	50 V	250 V	250 V	500V	500V	1000V	2500V	3600V	7200V	
3.0	3R0	16 V	25 V	50 V	250 V	250 V	500V	500V	1000V	2500V	3600V	7200V	
3.3	3R3	16 V	25 V	50 V	250 V	250 V	500V	500V	1000V	2500V	3600V	7200V	
3.6	3R6	16 V	25 V	50 V	250 V	250 V	500V	500V	1000V	2500V	3600V	7200V	
3.9	3R9	16 V	25 V	50 V	250 V	250 V	500V	500V	1000V	2500V	3600V	7200V	
4.3	4R3	16 V	25 V	50 V	250 V	250 V	500V	500V	1000V	2500V	3600V	7200V	
4.7	4R7	16 V	25 V	50 V	250 V	250 V	500V	500V	1000V	2500V	3600V	7200V	
5.1	5R1	16 V	25 V	50 V	250 V	250 V	500V	500V	1000V	2500V	3600V	7200V	
5.6	5R6	16 V	25 V	50 V	250 V	250 V	500V	500V	1000V	2500V	3600V	7200V	
6.2	6R2	16 V	25 V	50 V	250 V	250 V	500V	500V	1000V	2500V	3600V	7200V	
6.8	6R8	16 V	25 V	50 V	250 V	250 V	500V	500V	1000V	2500V	3600V	7200V	
7.5	7R5	16 V	25 V	50 V	250 V	250 V	500V	500V	1000V	2500V	3600V	7200V	
8.2	8R2	16 V	25 V	50 V	250 V	250 V	500V	500V	1000V	2500V	3600V	7200V	
9.1	9R1	16 V	25 V	50 V	250 V	250 V	500V	500V	1000V	2500V	3600V	7200V	
10	100	16 V	25 V	50 V	250 V	250 V	500V	500V	1000V	2500V	3600V	7200V	
11	110	16 V	25 V	50 V	250 V	250 V	500V	500V	1000V	2500V	3600V	7200V	
12	120	16 V	25 V	50 V	250 V	250 V	500V	500V	1000V	2500V	3600V	7200V	
13	130	16 V	25 V	50 V	250 V	250 V	500V	500V	1000V	2500V	3600V	7200V	
15	150	16 V	25 V	50 V	250 V	250 V	500V	500V	1000V	2500V	3600V	7200V	
16	160	16 V	25 V	50 V	250 V	250 V	500V	500V	1000V	2500V	3600V	7200V	
18	180		25 V	50 V	250 V	250 V	500V	500V	1000V	2500V	3600V	7200V	
20	200		25 V	50 V	250 V	250 V	500V	500V	1000V	2500V	3600V	7200V	
22	220		25 V	50 V	250 V	250 V	500V	500V	1000V	2500V	3600V	7200V	
24	240		25 V	50 V	250 V	250 V	500V	500V	1000V	2500V	3600V	7200V	
27	270		25 V	50 V	250 V	250 V	500V	500V	1000V	2500V	3600V	7200V	
30	300		25 V	50 V	250 V	250 V	500V	500V	1000V	2500V	3600V	7200V	
33	330		25 V	50 V	250 V	250 V	500V	500V	1000V	2500V	3600V	7200V	

* The R05W parts, which are X7R, can only be provided with "K" or "M" tolerance.

Consult factory for Non-Standard values.

**A tolerance only available for R07S (0402) and R14S(0603) caps

LOW ESR / HIGH-Q CAPACITOR SELECTION CHART

EIA Size Cap. Value		Miniature Size - Portable Electronics				RF Power Applications								
		01005 (R03S)	0201 (R05) NPO (R05L) X7R* (R05W)		0402 (R07S)	0603 (R14S)	0805 (R15S)	0805 (R15E)	1111 (S42E)	2525 (S48E)	3838 (S58E)			
Capacitance pF	Code	Voltage												
36	360		25 V			250 V	250 V	500V	500V	1000V	2500V	3600V	7200V	
39	390		25 V			250 V	250 V	500V	500V	1000V	2500V	3600V	7200V	
43	430		25 V			250 V	250 V	500V	500V	1000V	2500V	3600V	7200V	
47	470		25 V			250 V	250 V	500V	500V	1000V	2500V	3600V	7200V	
51	510		25 V			250 V	250 V	500V	500V	1000V	2500V	3600V	7200V	
56	560		25 V			250 V	250 V	500V	500V	1000V	2500V	3600V	7200V	
62	620		25 V			250 V	250 V	500V	500V	1000V	2500V	3600V	7200V	
68	680		25 V			250 V	250 V	500V	500V	1000V	2500V	3600V	7200V	
75	750		25 V			250 V	250 V	500V	500V	1000V	2500V	3600V	7200V	
82	820	F	25 V			250 V	250 V	500V	500V	1000V	2500V	3600V	7200V	
91	910		25 V			250 V	250 V	500V	500V	1000V	2500V	3600V	7200V	
100	101		25 V			250 V	250 V	500V	500V	1000V	2500V	3600V	7200V	
110	111	G		16 V			250 V		300V	500V	2500V	3600V	7200V	
120	121						250 V		300V	500V	2500V	3600V	7200V	
130	131	J					250 V		300V	500V	2500V	3600V	7200V	
150	151						250 V		300V	500V	2500V	3600V	7200V	
160	161	K					250 V		300V	500V	2500V	3600V	7200V	
180	181						250 V		300V	500V	2500V	3600V	7200V	
200	201						250 V		300V	500V	2500V	3600V		
220	221			16 V			250 V		200V	500V	2500V	3600V		
240	241								200V	500V	2500V	3600V		
270	271								200V	500V	2500V	3600V		
300	301								200V	500V	1500V	2500V		
330	331								200V	500V	1500V	2500V		
360	361								200V	500V	1500V	2500V		
390	391								200V	500V	1500V	2500V		
430	431								200V	500V	1500V	2500V		
470	471			16 V					200V	500V	1500V	2500V		
510	511								100V	500V	1000V	2500V		
560	561								100V	500V	1000V	2500V		
620	621								100V	500V	1000V	2500V		
680	681			16 V					50V		1000V	2500V		
750	751								50V		1000V	2500V		
820	821	G		16 V					50V		1000V	2500V		
910	911								50V		1000V	1000V		
1000	102			10 V					50V		1000V	1000V		
1200	122	J									1000V	1000V		
1500	152										500V	1000V		
1800	182	K									500V	1000V		
2200	222			10 V							300V	1000V		
2700	272										300V	500V		
3300	332											500V		
3900	392											500V		
4700	472			10 V								500V		
5100	512											500V		
10000	103			6.3 V										

* The R05W parts, which are X7R, can only be provided with "K" and "M" tolerance.
Consult factory for Non-Standard values.

DIELECTRIC CHARACTERISTICS

NPO

X7R

TEMPERATURE COEFFICIENT:	0 ± 30ppm /°C, -55 to 125°C	± 15%, -55 to 125°C
QUALITY FACTOR / DF:	Q > 1,000 @ 1 MHz, Typical 10,000	16VDC DF ≤ 3.5% @ 1 KHz, 25°C 10VDC DF ≤ 5.0% @ 1 KHz, 25°C
INSULATION RESISTANCE:	> 100 GΩ @ 25°C, WVDC; 125°C IR is 10% of 25°C rating	> 500 ΩF* or 10 GΩ* @ 25°C, WVDC; 125°C IR is 10% of 25°C rating * whichever is less
DIELECTRIC STRENGTH:	500 V ≤ 2.5 X WVDC Min., 25°C, 50 mA max 1000 V ≤ 1.5 X WVDC Min., 25°C, 50 mA max > 1500 = 1 X WVDC Min., 25°C, 50 mA max	2.5 X WVDC Min., 25°C, 50 mA max 1KHz ±50Hz, 1.0±0.2 VRMS, 25°C 100 - 10,000 pF
TEST PARAMETERS::	1MHz ±50kHz, 1.0±0.2 VRMS, 25°C	
AVAILABLE CAPACITANCE:		
Size 01005:	0.2 - 10 pF	Size 0805: 0.3 - 220 pF
Size 0201:	0.2 - 100 pF	Size 1111: 0.2 - 1000 pF
Size 0402:	0.2 - 33 pF	Size 2525: 1.0 - 2700 pF
Size 0603:	0.2 - 100 pF	Size 3838: 1.0 - 5100 pF

MECHANICAL & ENVIRONMENTAL CHARACTERISTICS

	SPECIFICATION	TEST PARAMETERS
SOLDERABILITY:	Solder coverage ≥ 90% of metalized areas No termination degradation	Preheat chip to 120°-150°C for 60 sec., dip terminals in rosin flux then dip in Sn62 solder @ 240°±5°C for 5±1 sec
RESISTANCE TO SOLDERING HEAT:	No mechanical damage Capacitance change: ±2.5% or 0.25pF Q>500 I.R. >10 G Ohms Breakdown voltage: 2.5 x WVDC	Preheat device to 80°-100°C for 60 sec. followed by 150°-180°C for 60 sec. Dip in 260°±5°C solder for 10±1 sec. Measure after 24±2 hour cooling period
TERMINAL ADHESION:	Termination should not pull off. Ceramic should remain undamaged.	Linear pull force* exerted on axial leads soldered to each terminal. *0402 ≥ 2.0lbs, 0603 ≥ 2.0lbs (min.)
PCB DEFLECTION:	No mechanical damage. Capacitance change: 2% or 0.5pF Max	Glass epoxy PCB: 0.5 mm deflection
LIFE TEST:	MIL-STD-202, Method 108I No mechanical damage Capacitance change: ±3.0% or 0.3 pF Q>500 I.R. >1 G Ohms Breakdown voltage: 2.5 x WVDC	Applied voltage: 120% of WDVC for capacitors rated at 500 volts DC or less. 100% of WDVC for capacitors rated at 1250 volts DC or less. Temperature: 125°±3°C Test time: 1000+48-0 hours
THERMAL CYCLE:	No mechanical damage. Capacitance change: ±2.5% or 0.25pF Q>2000 I.R. >10 G Ohms Breakdown voltage: 2.5 x WVDC	5 cycles of: 30±3 minutes @ -55°+0/-3°C, 2-3 min. @ 25°C, 30±3 min. @ +125°+3/-0°C, 2-3 min. @ 25°C Measure after 24±2 hour cooling period
HUMIDITY, STEADY STATE:	No mechanical damage. Capacitance change: ±5.0% or 0.50pF max. Q>300 I.R. ≥ 1 G-Ohm Breakdown voltage: 2.5 x WVDC	Relative humidity: 90-95% Temperature: 40°±2°C Test time: 500 +12/-0 Hours Measure after 24±2 hour cooling period
HUMIDITY, LOW VOLTAGE:	No mechanical damage. Capacitance change: ±5.0% or 0.50pF max. Q>300 I.R. = 1 G-Ohm min. Breakdown voltage: 2.5 x WVDC	Applied voltage: 1.5 VDC, 50 mA max. Relative humidity: 85±2% Temperature: 40°±2°C Test time: 240 +12/-0 Hours Measure after 24±2 hour cooling period
VIBRATION:	No mechanical damage. Capacitance change: ±2.5% or 0.25pF Q>1000 I.R. ≥ 10 G-Ohm Breakdown voltage: 2.5 x WVDC	Cycle performed for 2 hours in each of three perpendicular directions Frequency range 10Hz to 55 Hz to 10 Hz traversed in 1 minute. Harmonic motion amplitude: 1.5mm



MECHANICAL CHARACTERISTICS

Size	Units	Length	Width	Thickness	End Band
EIA 01005	In	.016 ±.001	.008 ±.001	.008 ±.001	.006 Max.
Metric (0402)	mm	(0.40 ±0.03)	(0.20 ±0.03)	(0.20 ±0.03)	(0.15 Max.)
EIA 0201	In	.024 ±.001	.012 ±.001	.012 ±.001	.008 Max.
Metric (0603)	mm	(0.60 ±0.03)	(0.30 ±0.03)	(0.30 ±0.03)	(0.20 Max.)
EIA 0402	In	.040 ±.004	.020 ±.004	.020 ±.004	.010 ±.006
Metric (1005)	mm	(1.02 ±0.1)	(0.51 ±0.1)	(0.51 ±0.1)	(0.25 ±.15)
EIA 0603	In	.062 ±.006	.032 ±.006	.030 +.005/-.003	.014 ±.006
Metric (1608)	mm	(1.57 ±0.15)	(0.81 ±0.15)	(0.76 +.13-.08)	(0.35 ±.15)
EIA 0805	In	.080 ±.008	.050 ±.008	.040 ±.006	.020 ±.010
Metric (2012)	mm	(2.03 ±0.20)	(1.27 ±0.20)	(1.02 ±.15)	(0.50 ±.25)

HORIZONTAL AND VERTICAL ORIENTED CAPACITORS

Horizontal Electrode Orientation

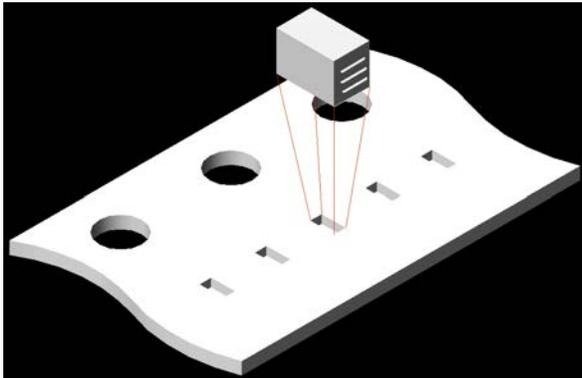

Vertical Electrode Orientation

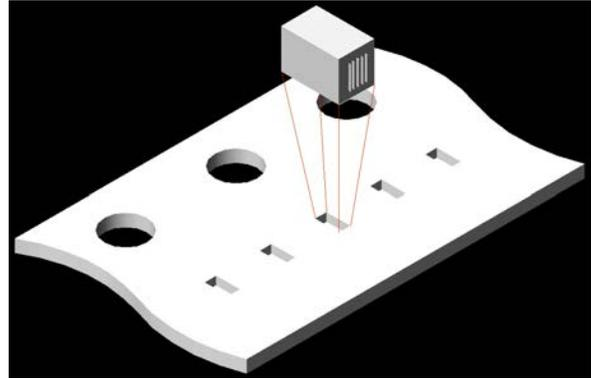

APPLICATIONS & FEATURES

Size:	EIA 0201, 0402
Performance:	SRF's up to 20 GHz, Ultra High Q, Tight tolerance, Ultralow ESR
Termination:	Ni/Au, Ni/Sn, Ni/SnPb
Applications:	High Frequency Wireless Communications, Portable Wireless Products, Battery Powered Products

RoHS Compliant

BENEFITS OF USING ORIENTED CAPACITORS

- Consistent Orientation - Improved repeatability of production circuits.
- Consistent Orientation - More consistent filter performance.
- Vertical Orientation - The elimination of parallel frequencies.
- Vertical Orientation - Lower inductance for a given capacitor.
- Horizontal Orientation - Lower coupling between adjacent capacitors.

E-SERIES TERMINATIONS AND LEADS

Termination	Size	Units	L	Tol	W	Tol	T	E / B	Tol
V, T U, C	S42E	In	0.110	+0.020 -0.010	0.110	+/- .015	0.102 Max.	0.015 Typ.	+/- 0.008
		mm	2.79	+0.51 -0.25	2.79	+/- 0.38	2.59 Max.	0.38 Typ.	+/- 0.20
	S48E	In	0.230	+0.025 -0.010	0.250	+/- .015	0.150 Max.	0.025 Typ.	
		mm	5.84	+0.63 -0.25	6.35	+/- 0.38	3.81 Max.	0.63 Typ.	
	S58E	In	0.380	+0.015 -0.010	0.380	+/- .010	0.170 Max.	0.025 Typ.	
		mm	9.65	+0.38 -0.25	9.65	+/- 0.25	4.32 Max.	0.63 Typ.	

For all E-Series Models:

OPERATING TEMP. :

-55 to +125°C

INSULATION RESISTANCE:

>1000 ΩF or >10 GΩ,
whichever is less
@ 25°C WVDC

TEMPERATURE COEFFICIENT:

0 ± 30ppm /°C, -55 to 125°C

DISSIPATION FACTOR (TYP):

< 0.05% @ 1 MHz

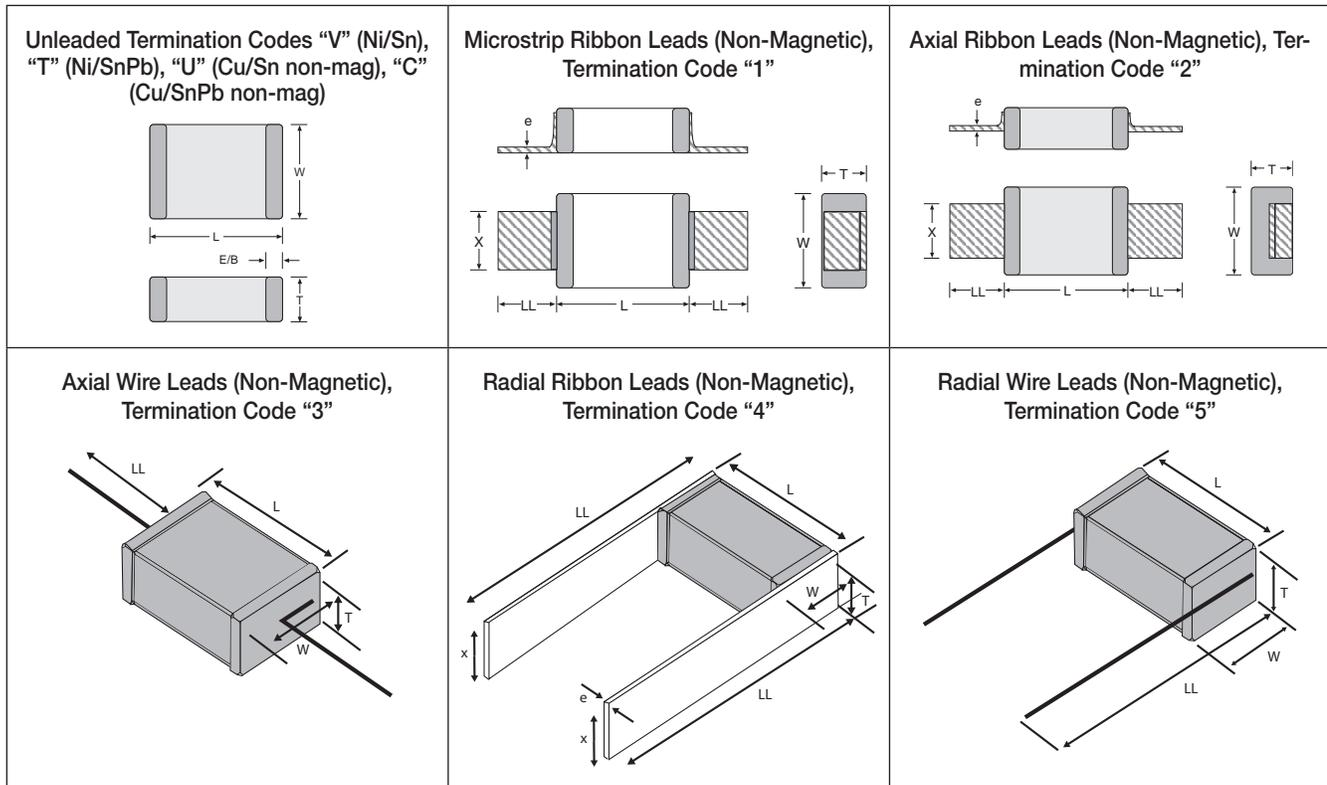

Lead	Size	Units	L	Tol	W	Tol	T (max)	E/B (typ)	LL(min)	X	Tol	e	Tol
1	S42E	In	0.135	+/- .015	0.110	+/- .020	0.102	0.015	0.25	0.093	+/-0.005	0.004	+/- 0.001
		mm	3.43	+/- 0.38	2.79	+/- 0.51	3.05	0.38	6.35	2.36	+/- 0.13	0.102	+/- 0.025
	S48E	In	0.245	+/- 0.025	0.250	+/- 0.015	0.160	0.025	0.50	0.240	+/- 0.005	0.004	+/- 0.001
		mm	6.22	+/- 0.64	6.35	+/- 0.38	3.81	0.63	12.7	6.10	+/- 0.13	0.102	+/- 0.025
	S58E	In	0.38	+0.035 / - 0.010	0.38	+/- 0.010	0.170	0.04 MAX.	0.750	0.35	+/- 0.010	0.010	+/- 0.005
		mm	9.65	+0.89 / -0.25	9.65	+/- 0.25	4.32	1.02 MAX.	19.05	8.89	+/- 0.25	0.25	+/- 0.13
2	S42E	In	0.135	+/- .015	0.110	+/- .020	0.102	0.015	0.25	0.093	+/-0.005	0.004	+/- 0.001
		mm	3.43	+/- 0.38	2.79	+/- 0.51	2.59	0.38	6.35	2.36	+/- 0.13	0.102	+/- 0.025
	S48E	In	0.245	+/- 0.025	0.250	+/- 0.015	0.160	0.025	0.50	0.240	+/- 0.005	0.004	+/- 0.001
		mm	6.22	+/- 0.64	6.35	+/- 0.38	3.81	0.63	12.7	6.10	+/- 0.13	0.102	+/- 0.025
	S58E	In	0.38	+0.035 / - 0.010	0.38	+/- 0.010	0.170	0.04 MAX.	0.750	0.35	+/- 0.010	0.010	+/- 0.005
		mm	9.65	+0.89 / -0.25	9.65	+/- 0.25	4.32	1.02 MAX.	19.05	8.89	+/- 0.25	0.25	+/- 0.13
3	S42E S48E S58E	In	0.145	+/- .020	0.110	+/- .015	0.102		0.50	#26 AWG, .016 (.406) dia. nominal			
		mm	3.68	+/- 0.51	2.79	+/- 0.38	2.59		12.70				
4	S42E S48E S58E	In	0.135	+/- .015	0.110	+/- .015	0.102		0.25	0.093	+/-0.005	0.004	+/- 0.001
		mm	3.43	+/- 0.38	2.79	+/- 0.38	2.59		6.35	2.36	+/- 0.13	0.102	+/- 0.025
5	S42E S48E S58E	In	0.145	+/- .020	0.110	+/- .015	0.102		0.50	#26 AWG, .016 (.406) dia. nominal			
		mm	3.68	+/- 0.51	2.79	+/- 0.38	2.59		12.70				

SERIES RESONANCE CHART

Typical Series Resonant Frequency (Series Mounted)

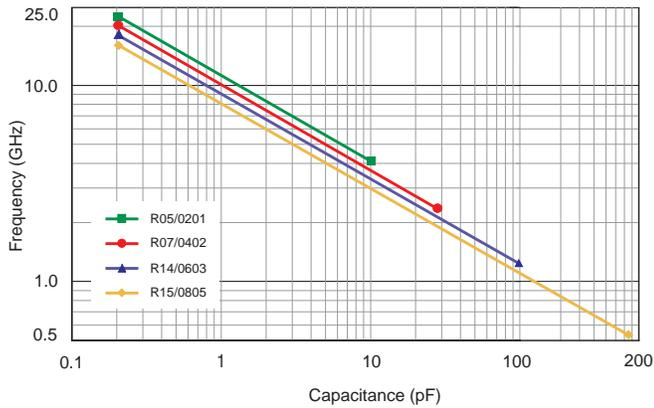

RF CHARACTERISTICS - L-SERIES

ESR vs Frequency: 0201/R05L

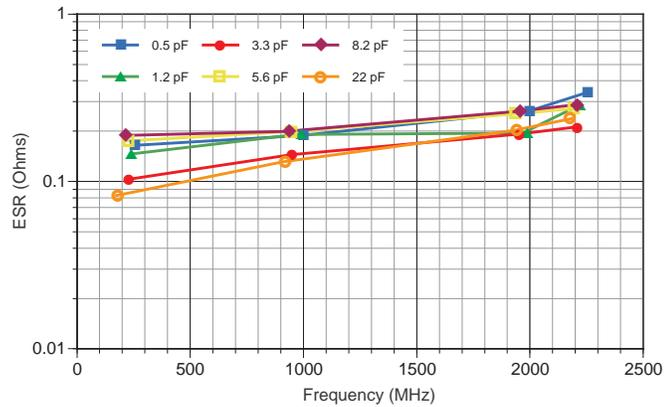

Q vs Frequency: 0201/R05L

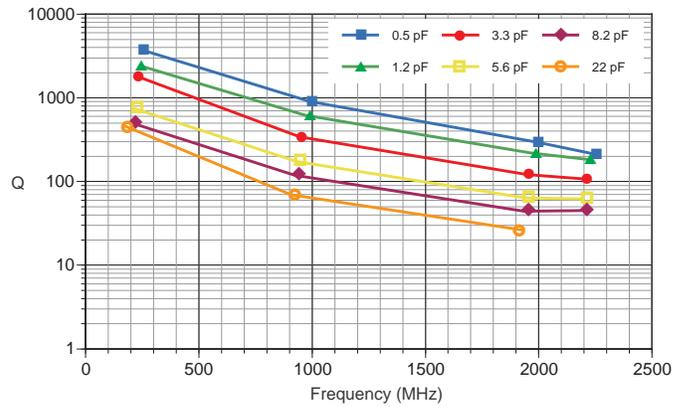

ESR vs Capacitance: 0201/R05L

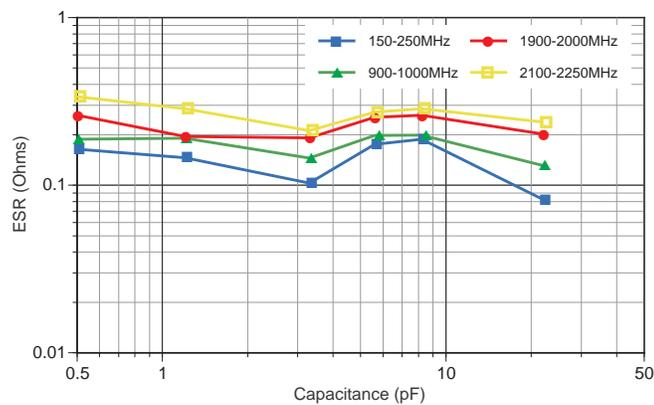

Q vs Capacitance: 0201/R05L

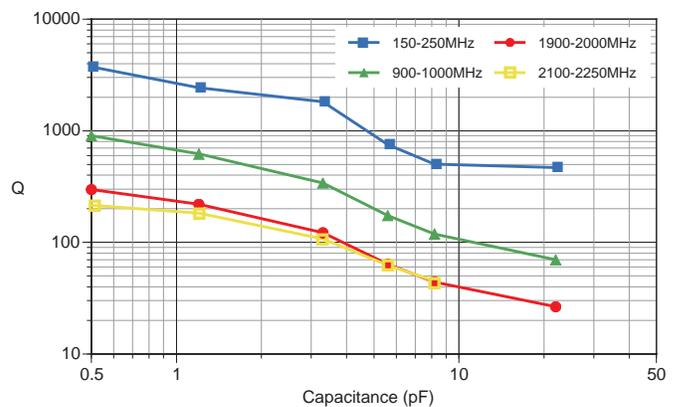

S-SERIES RF CHARACTERISTICS VERSUS FREQUENCY

Equivalent Series Resistance: 0402/R07S

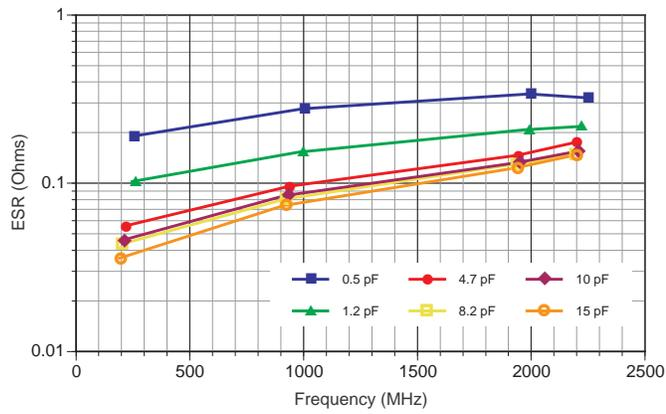

Q Factor: 0402/R07S

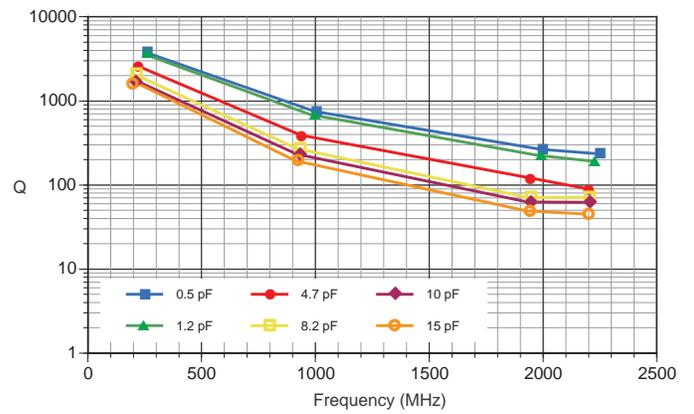

Equivalent Series Resistance: 0603/R14S

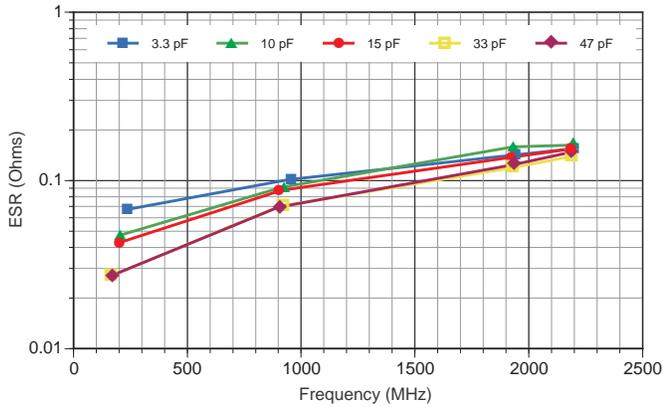

Q Factor: 0603/R14S

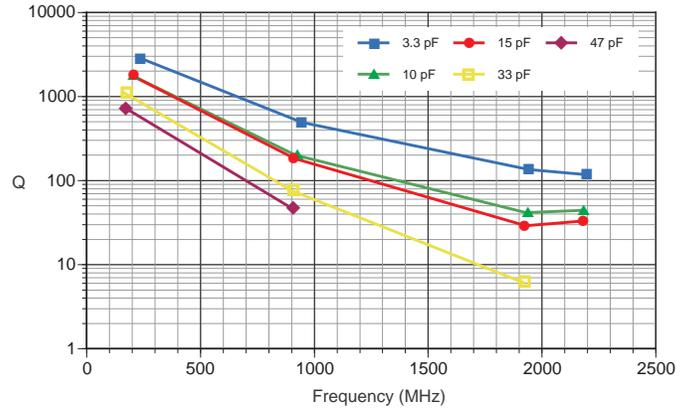

Equivalent Series Resistance: 0805/R15S

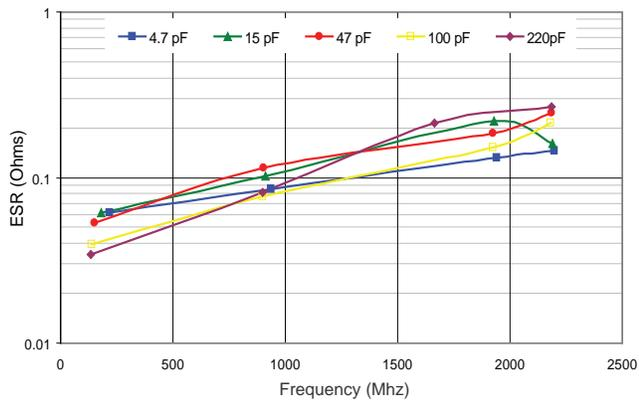

Q Factor: 0805/R15S

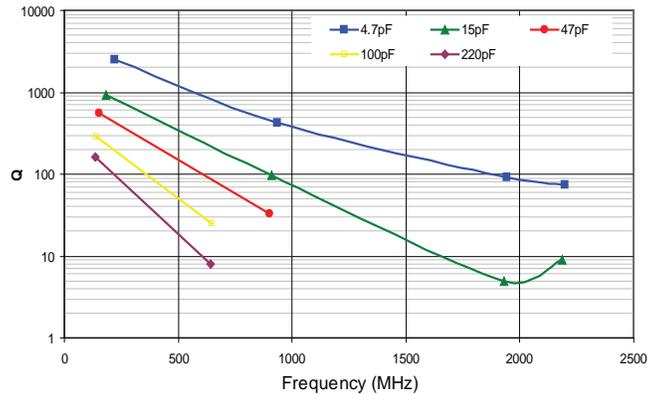

Measurements performed on a Boonton 34A Resonant Coaxial Line and represent typical capacitor performance.

S-SERIES RF CHARACTERISTICS VERSUS CAPACITANCE

Equivalent Series Resistance: 0402/R07S

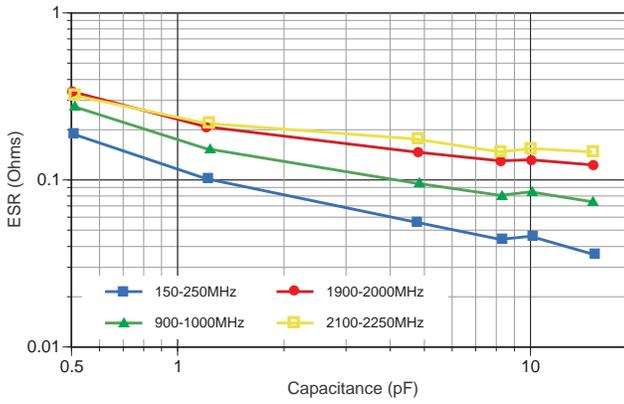

Q Factor: 0402/R07S

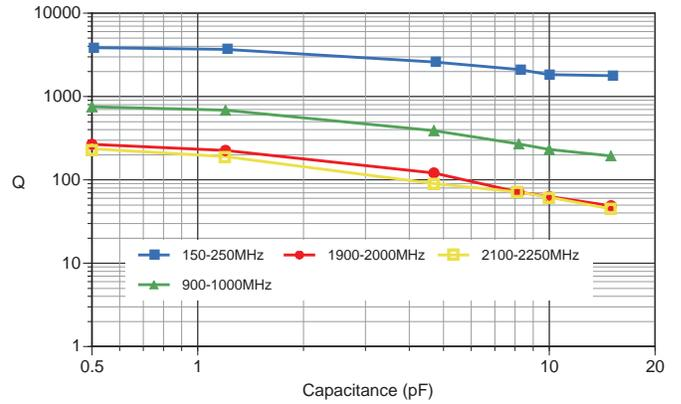

Equivalent Series Resistance: 0603/R14S

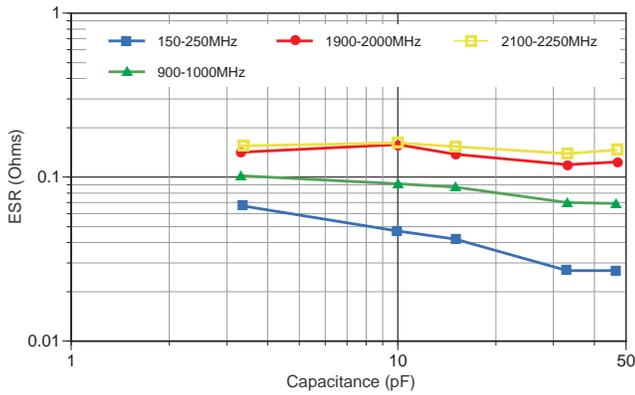

Q Factor: 0603/R14S

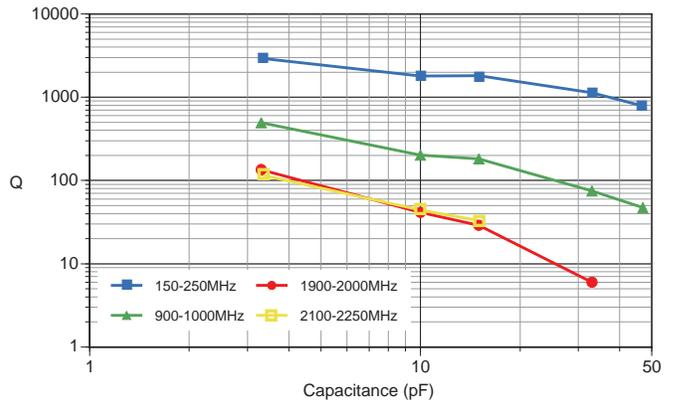

Equivalent Series Resistance: 0805/R15S

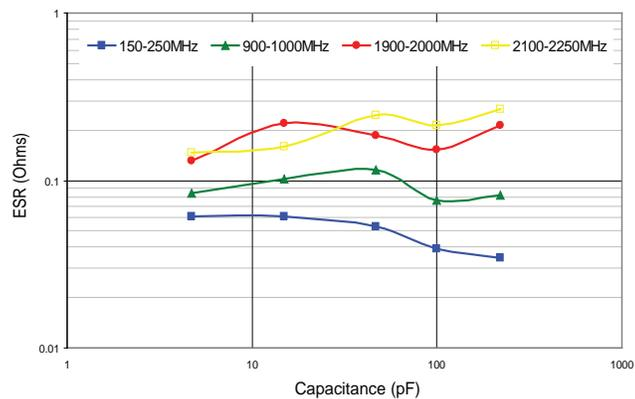

Q Factor: 0805/R15S

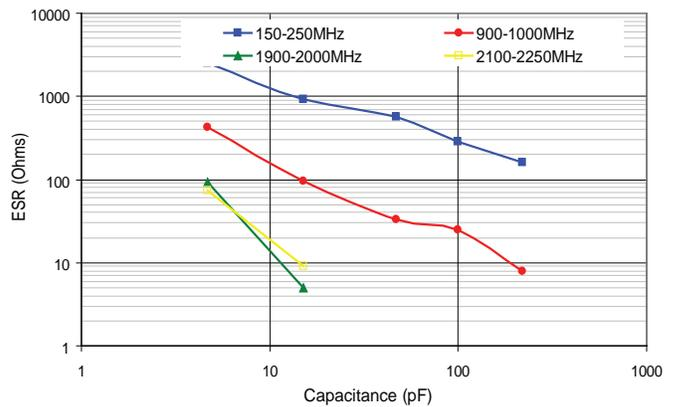

Measurements performed on a Boonton 34A Resonant Coaxial Line and represent typical capacitor performance.

S42E SERIES RF CHARACTERISTICS VERSUS FREQUENCY

Equivalent Series Resistance: 1111/S42E

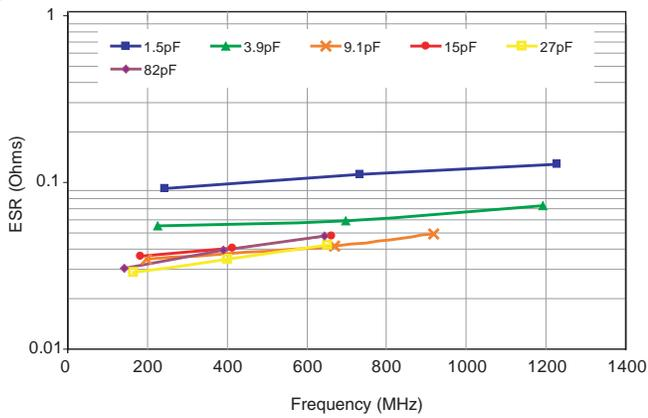

Q Factor: 1111/S42E

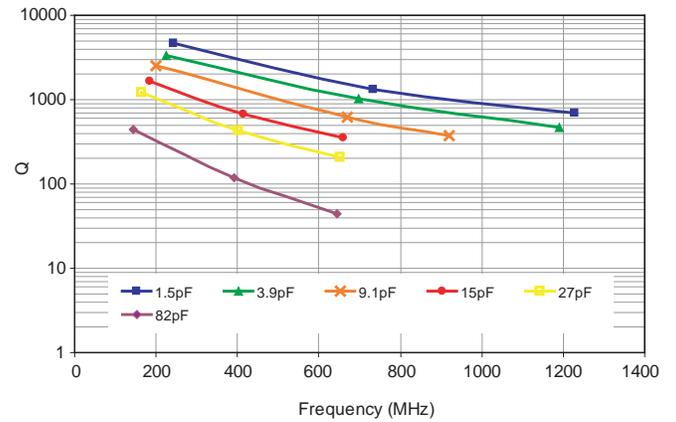

S42E SERIES RF CHARACTERISTICS VERSUS CAPACITANCE

S42E Equivalent Series Resistance vs Capacitance, Typical

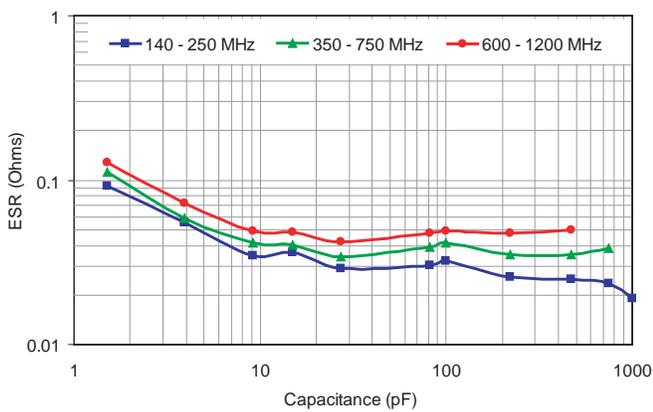

S42E Q vs. Capacitance, Typical

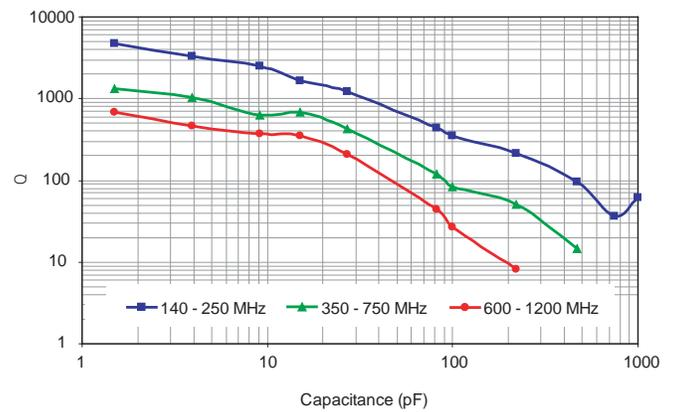

S42E SRF (Series Mount), Typical

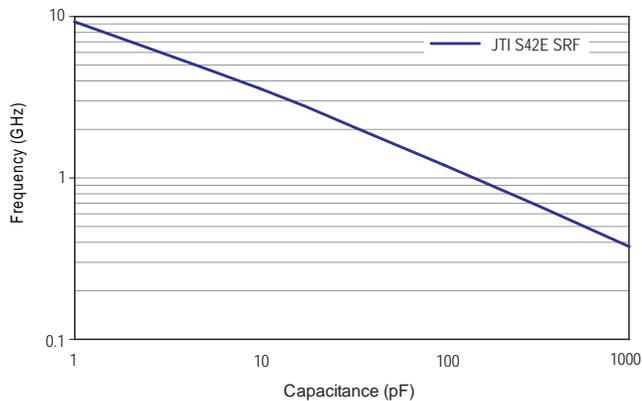

SRF (Shunt Mount), S48E, Typical (Preliminary)

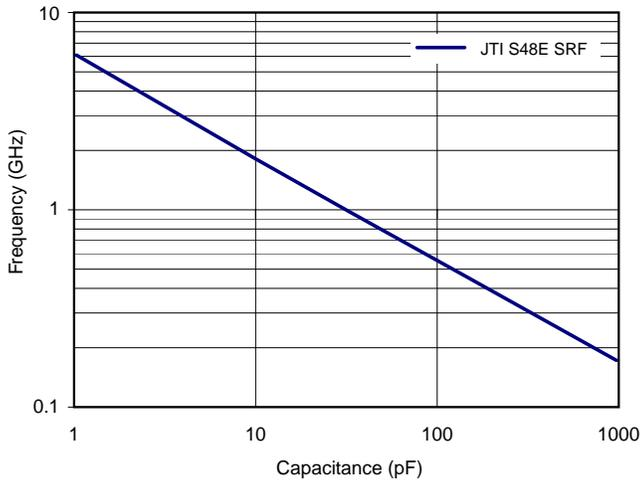

As measured on a 8720C VNA, using a Shunt-Through fixture, and using the S11 magnitude dip to determine the SRF

Current Rating vs. Capacitance, S48E, Typical (Preliminary)

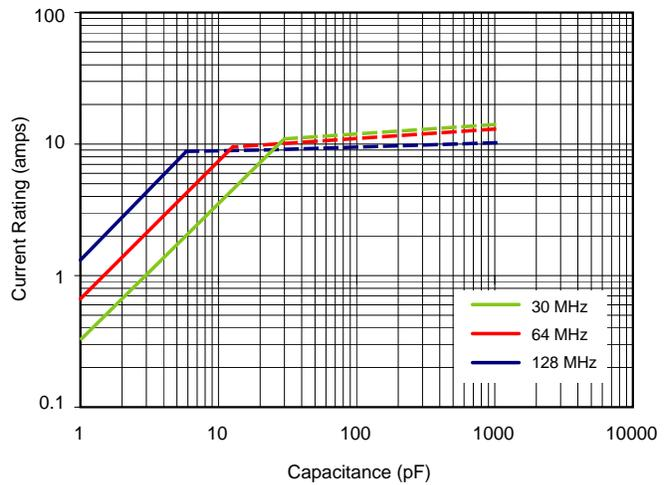

Solid traces show voltage limited current (Vrms)

Dotted traces show power dissipation limited current (Based on 4 Watts Power Dissipation, and 125 degrees C case temp.)

S48E Q vs. Capacitance, Typical (Preliminary)

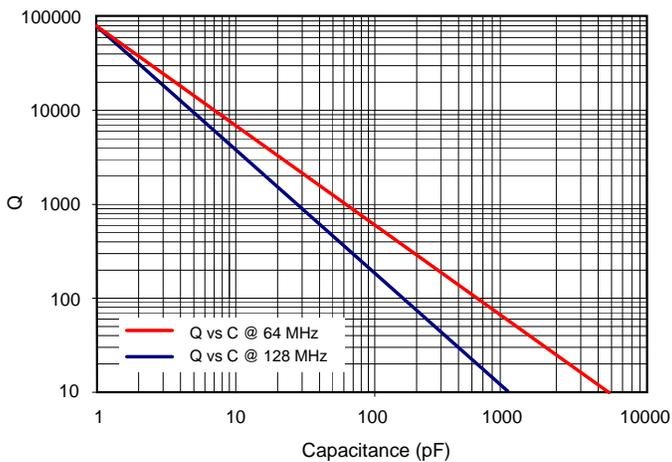

As measured on a 4287A LCR meter, using a 16092A fixture

S48E ESR vs. Capacitance, Typical (Preliminary)

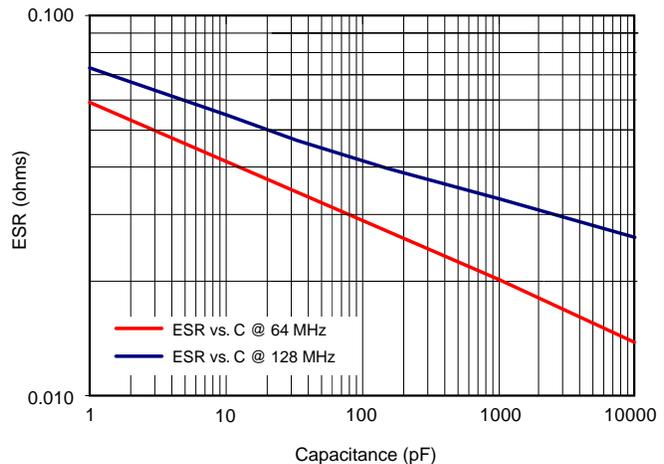

As measured on a 4287A LCR meter, using a 16092A fixture

JTI S48E GRAPHICAL DATA

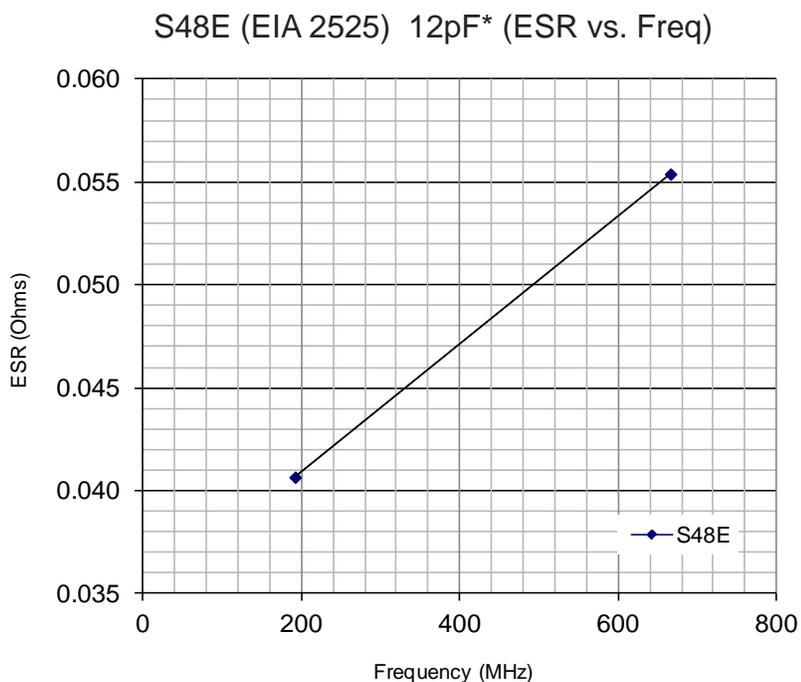

JTI S58E GRAPHICAL DATA

