

CMOS LDO Regulator Series for Automotive Ultra-Small Package FULL CMOS LDO Regulator

BUxxJA2MNVX-C series

General Description

BUxxJA2MNVX-C series are high-performance FULL CMOS regulators with 200mA output, which are mounted on versatile package SSON004R1010 (1.00mm x 1.00mm x 0.60mm). These devices have excellent noise characteristics and load responsiveness characteristics despite its low circuit current consumption of 35 μ A. They are most appropriate for various applications such as power supplies for radar and camera of the automotive.

Features

- AEC-Q100 Qualified^(Note 1)
- High Accuracy Output
- Low Current Consumption
- Compatible With Small Ceramic Capacitor($C_{IN}=C_O=0.47\mu F$)
- With Built-in Output Discharge Circuit
- High Ripple Rejection
- ON/OFF Control of Output Voltage
- Built-in Over Current Protection Circuit
- Built-in Thermal Shutdown Circuit
(Note 1) Grade1

Applications

- Radar and camera for automotive, etc.

Key Specifications

- Input Voltage Range: 1.7V to 6.0V
- Output Voltage: 1.0V to 3.4V
- Output Voltage Accuracy: $\pm 2.0\%$ ($T_a=-40^\circ C$ to $125^\circ C$)
- Output Current: 200mA(Max)
- Standby Current: 35 μ A (Typ)
- Operating Temperature Range: $-40^\circ C$ to $+125^\circ C$

Package

SSON004R1010 : W(Typ) x D(Typ) x H(Max)
1.00mm x 1.00mm x 0.60mm

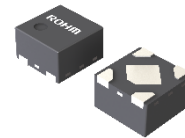

SSON004R1010

Typical Application Circuit

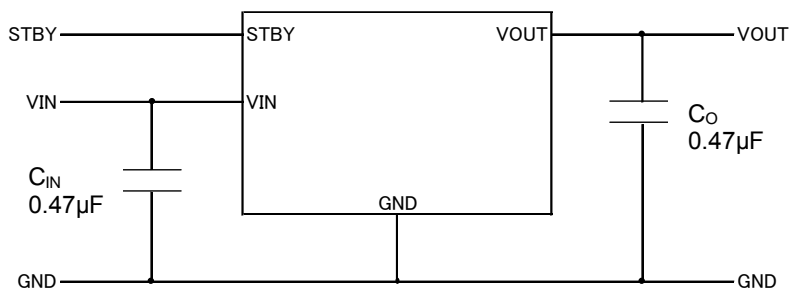

Figure 1. Application Circuit

Ordering Information

| | | | | | |
|-------------------------------|---|----------------|--------------|------------------|--|
| B U x x J A 2 M N V X - C T L | | | | | |
| Part Number | Output Voltage | Output Current | Category | Package | Product Rank |
| | 10 : 1.0V 11 : 1.1V 12 : 1.2V 1C : 1.25V 15 : 1.5V 18 : 1.8V 25 : 2.5V 28 : 2.8V 2J : 2.85V 29 : 2.9V 30 : 3.0V 33 : 3.3V 34 : 3.4V | 200mA | M:Automotive | NVX:SSON004R1010 | C:for Automotive Packaging and forming specification TL: Embossed tape and reel |

Block Diagram

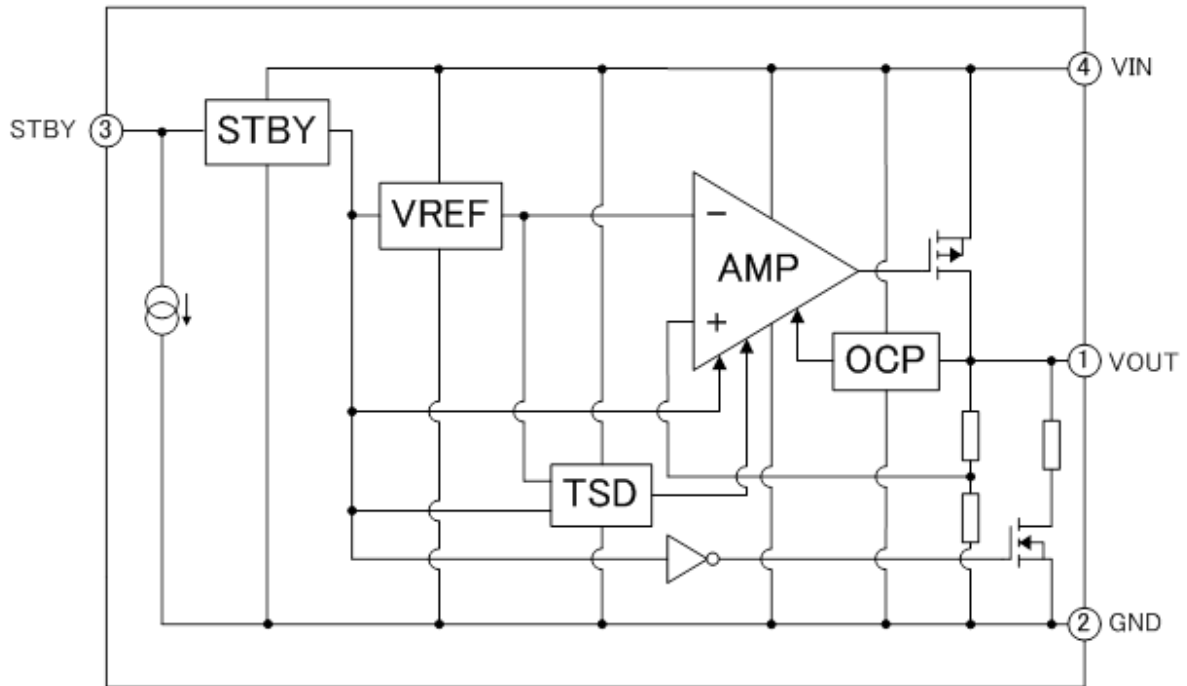
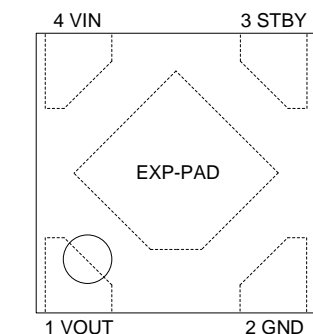

Figure 2. Block Diagram

Pin Descriptions

| Pin No. | Pin name | Pin Function |
|-----------|----------|---|
| 1 | VOUT | Output Voltage |
| 2 | GND | Ground |
| 3 | STBY | ON/OFF control of output voltage (High: ON, Low: OFF) |
| 4 | VIN | Power Supply Voltage |
| Back side | EXP-PAD | Connect to GND |

Pin Configurations



SSON004R1010 (TOP VIEW)^(Note1)
(Note1)The dashed line is the electrode position of the back side.

Absolute Maximum Ratings

| Parameter | Symbol | Rating | Unit |
|------------------------------|------------|--------------|------|
| Power Supply Voltage | V_{IN} | -0.3 to +6.5 | V |
| STBY Voltage | V_{STBY} | -0.3 to +6.5 | V |
| Operating Temperature Range | T_{opr} | -40 to +125 | °C |
| Storage Temperature Range | T_{stg} | -55 to +150 | °C |
| Maximum junction temperature | T_{jmax} | +150 | °C |

Recommended Operating Range

| Parameter | Symbol | Min | Max | Unit |
|------------------------|------------|-----|-----|------|
| Power Supply Voltage | V_{IN} | 1.7 | 6.0 | V |
| STBY Voltage | V_{STBY} | 0.0 | 6.0 | V |
| Maximum Output Current | I_{OUT} | - | 200 | mA |

Recommended Operating Conditions

| Parameter | Symbol | Min | Typ | Max | Unit | Conditions |
|------------------|----------|------------------|------|-----|---------------|-------------------------------|
| Input Capacitor | C_{IN} | 0.22 (Note 1) | 0.47 | - | μF | Ceramic capacitor recommended |
| Output Capacitor | C_{O} | 0.22 (Note 1) | 0.47 | - | μF | Ceramic capacitor recommended |

(Note 1) Caution that the capacitance to be kept higher than this specified values under all conditions considering temperature, DC bias, etc.

Thermal Resistance (Note 1)

| Parameter | Symbol | Thermal Resistance (Typ) | | Unit |
|--|---------------|--------------------------|--------------------------|------|
| | | 1s ^(Note 3) | 2s2p ^(Note 4) | |
| SSON004R1010 | | | | |
| Junction to Ambient | θ_{JA} | 450.2 | 97.1 | °C/W |
| Junction to Top Characterization Parameter ^(Note 2) | Ψ_{JT} | 99 | 22 | °C/W |

(Note 1) Based on JE51-2A(Still-Air).

(Note 2) The thermal characterization parameter to report the difference between junction temperature and the temperature at the top center of the outside surface of the component package.

(Note 3) Using a PCB board based on JE51-3.

(Note 4) Using a PCB board based on JE51-5, 7.

| Layer Number of Measurement Board | Material | Board Size |
|-----------------------------------|----------|-------------------------------|
| Single | FR-4 | 114.3 mm x 76.2 mm x 1.57 mmt |

| Top | |
|-----------------------|------------|
| Copper Pattern | Thickness |
| Footprints and Traces | 70 μ m |

| Layer Number of Measurement Board | Material | Board Size | Thermal Via ^(Note 5) | |
|-----------------------------------|----------|------------------------------|---------------------------------|----------------|
| | | | Pitch | Diameter |
| 4 Layers | FR-4 | 114.3 mm x 76.2 mm x 1.6 mmt | 1.20 mm | Φ 0.30 mm |

| Top | | 2 Internal Layers | | Bottom | |
|-----------------------|------------|-------------------|------------|-------------------|------------|
| Copper Pattern | Thickness | Copper Pattern | Thickness | Copper Pattern | Thickness |
| Footprints and Traces | 70 μ m | 74.2 mm x 74.2 mm | 35 μ m | 74.2 mm x 74.2 mm | 70 μ m |

(Note 5) This thermal via connects with the copper pattern of all layers.

Electrical Characteristics

(Ta= -40°C to 125°C, VIN=VOUT+1.0V (Note 1), STBY=VIN, CIN=0.47μF, Co=0.47μF, unless otherwise specified.)

| Parameter | Symbol | Limit | | | Unit | Conditions | |
|---------------------------------------|--------|---------------|-----|---------------|------|---|--|
| | | Min | Typ | Max | | | |
| [Regulator Block] | | | | | | | |
| Output Voltage 1 | VOUT1 | VOUT ×0.98 | - | VOUT ×1.02 | V | IOUT=0.01mA, VOUT≥1.8V | |
| | | VOUT -36mV | - | VOUT +36mV | | IOUT=0.01mA, VOUT<1.8V | |
| Output Voltage 2 | VOUT2 | VOUT ×0.97 | - | VOUT ×1.03 | V | IOUT=0.01mA to 200mA VOUT≥1.8V | |
| | | VOUT -54mV | - | VOUT +54mV | | IOUT=0.01mA to 200mA VOUT<1.8V | |
| Circuit Current | IIN | - | 35 | 90 | μA | IOUT=0mA | |
| Circuit Current (STBY) | ISTBY | - | - | 2.0 | μA | STBY=0V | |
| Ripple Rejection Ratio | RR | 45 | 70 | - | dB | VRR=-20dBV, fRR=1kHz IOUT=10mA, Ta=25°C | |
| Dropout Voltage | VSAT | - | 800 | 1100 | mV | 1.0V ≤ VOUT < 1.2V(IOUT=200mA) | |
| | | - | 600 | 900 | mV | 1.2V ≤ VOUT < 1.5V(IOUT=200mA) | |
| | | - | 440 | 830 | mV | 1.5V ≤ VOUT < 1.8V(IOUT=200mA) | |
| | | - | 380 | 710 | mV | 1.8V ≤ VOUT < 2.5(IOUT=200mA) | |
| | | - | 280 | 620 | mV | 2.5V ≤ VOUT ≤ 2.6(IOUT=200mA) | |
| | | - | 260 | 580 | mV | 2.7V ≤ VOUT ≤ 2.85(IOUT=200mA) | |
| | | - | 240 | 530 | mV | 2.9V ≤ VOUT ≤ 3.1V(IOUT=200mA) | |
| | | - | 220 | 490 | mV | 3.2V ≤ VOUT ≤ 3.4V(IOUT=200mA) | |
| Line Regulation | VDL | - | 2 | 20 | mV | VIN=VOUT+1.0V to 5.5V (Note 2) IOUT=0.01mA | |
| Load Regulation | VDLO | - | 10 | 80 | mV | IOUT=0.01mA to 100mA | |
| [Over Current Protection (OCP) Block] | | | | | | | |
| Limit Current | ILMAX | 220 | 400 | 700 | mA | ILMAX@VOUT×0.95, Ta=25°C | |
| Short Current | ISHORT | 20 | 70 | 150 | mA | VOUT=0V, Ta=25°C | |
| [Standby Block] | | | | | | | |
| Discharge Resistor | RDSC | 20 | 50 | 80 | Ω | VIN=4.0V, STBY=0V VOUT=4.0V, Ta=25°C | |
| STBY Pin Pull-down Current | ISTB | 0.1 | 0.6 | 2.0 | μA | STBY=1.5V | |
| STBY Control Voltage | ON | VSTBH | 1.2 | - | 6.0 | V | |
| | OFF | VSTBL | 0 | - | 0.3 | V | |

(Note 1) VIN=2.5V for VOUT≤1.5V
 (Note 2) VIN=2.5V to 3.6V for VOUT≤1.5V

Reference data BU33JA2MNVX-C (Ta=25°C unless otherwise specified.)

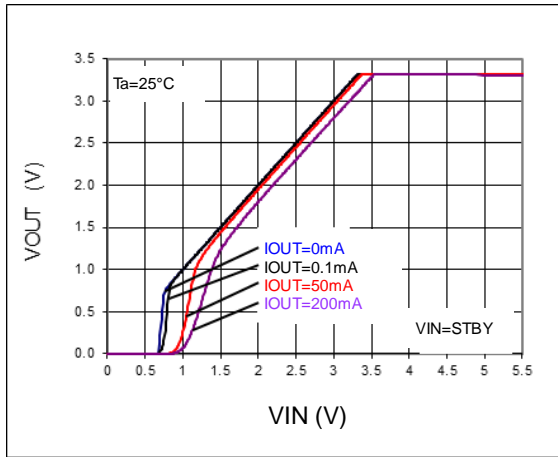

Figure 3. Output Voltage

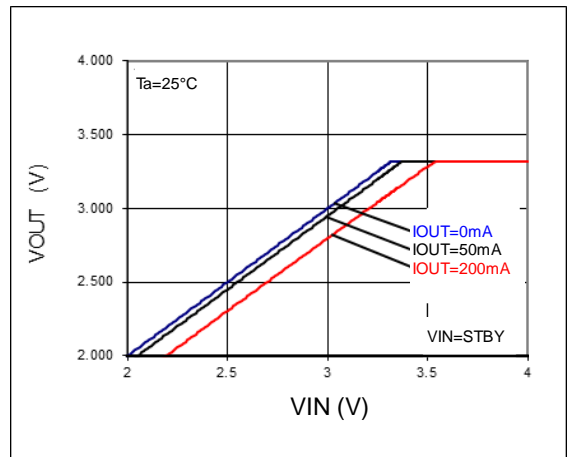

Figure 4. Output Voltage

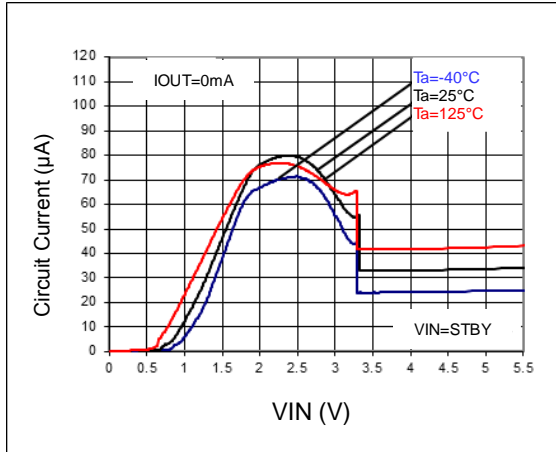

Figure 5. Circuit Current

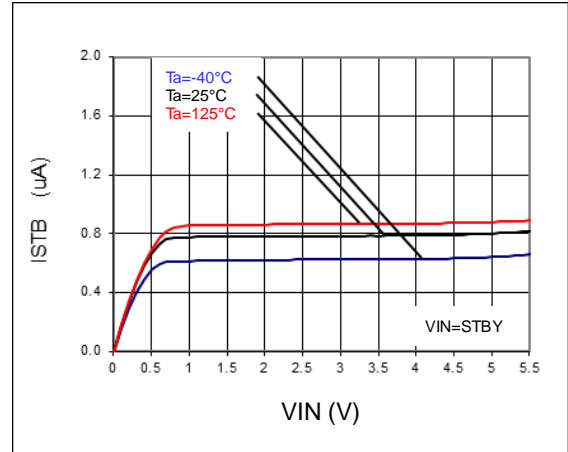

Figure 6. VSTBY - ISTB

Reference data BU33JA2MNVX-C (Ta=25°C unless otherwise specified.)

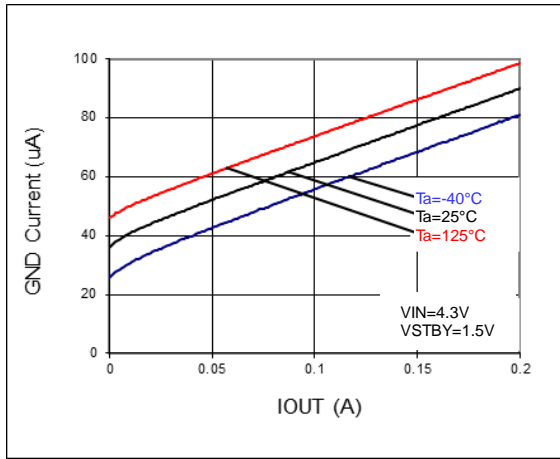

Figure 7. IOUT - IGND

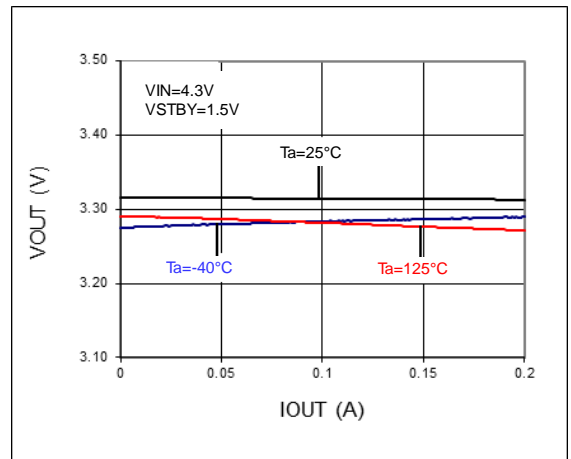

Figure 8. Load Regulation

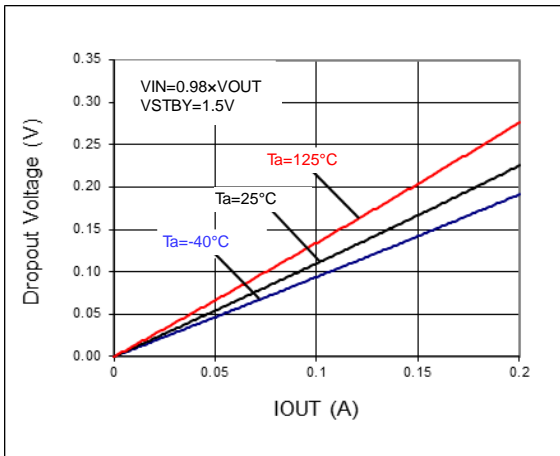

Figure 9. Dropout Voltage

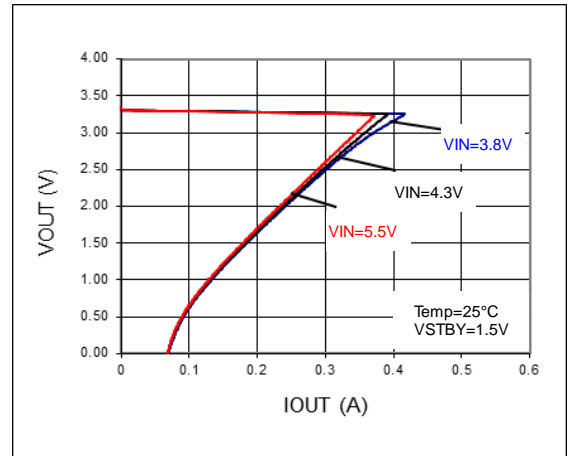

Figure 10. OCP Threshold

Reference data BU33JA2MNVX-C (Ta=25°C unless otherwise specified.)

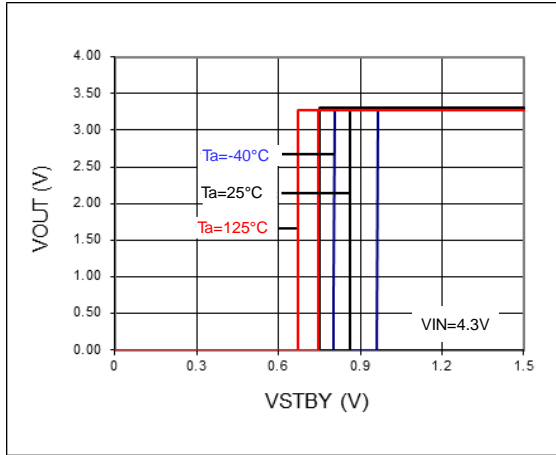

Figure 11. STBY Threshold

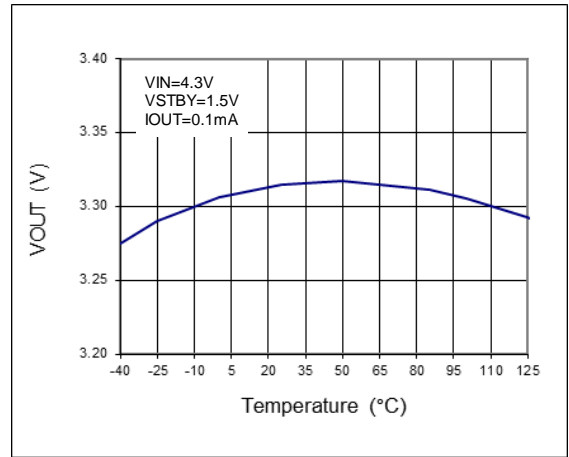

Figure 12. VOUT - Temp

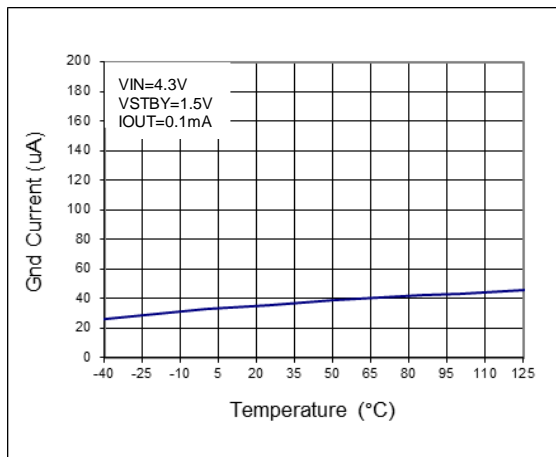

Figure 13. IGND - Temp

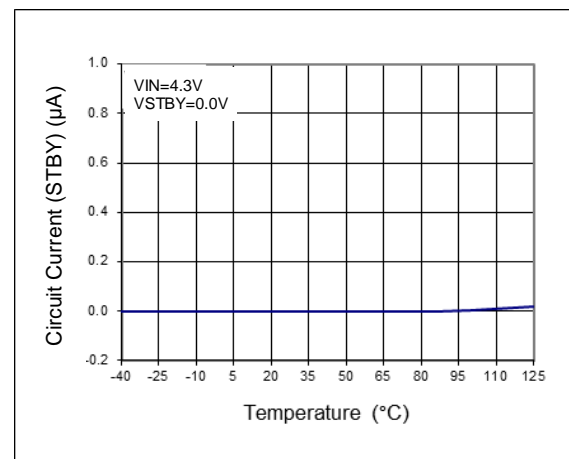

Figure 14. Circuit Current (STBY) - Temp

Reference data BU33JA2MNVX-C (Ta=25°C unless otherwise specified.)

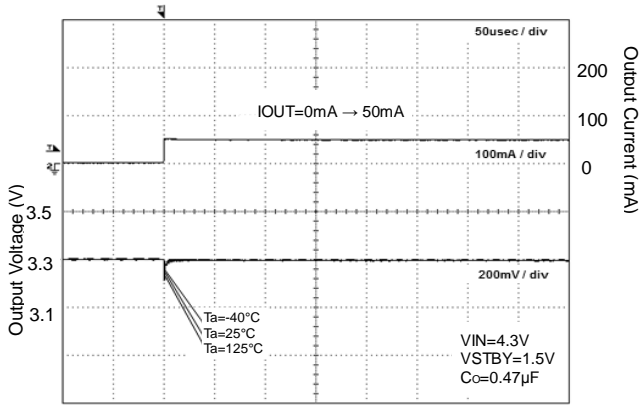

Figure 15. Load Response

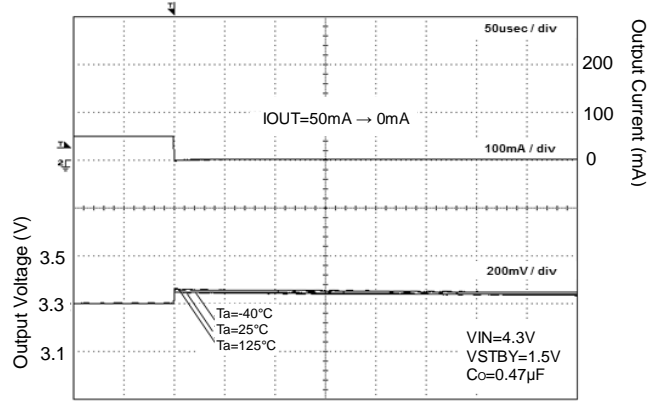

Figure 16. Load Response

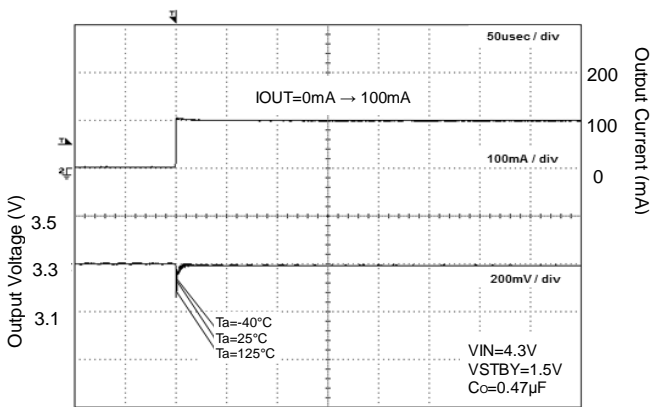

Figure 17. Load Response

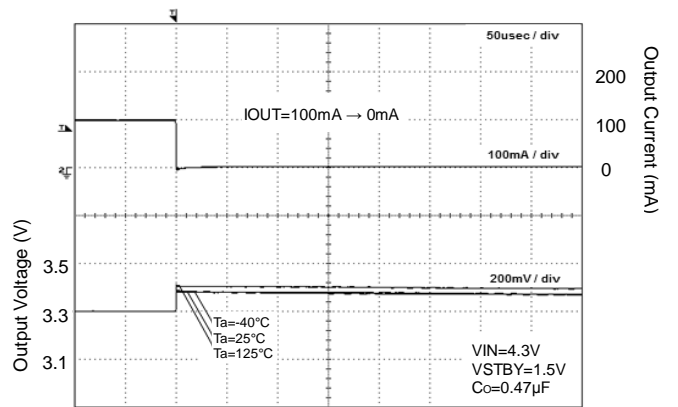

Figure 18. Load Response

Reference data BU33JA2MNVX-C (Ta=25°C unless otherwise specified.)

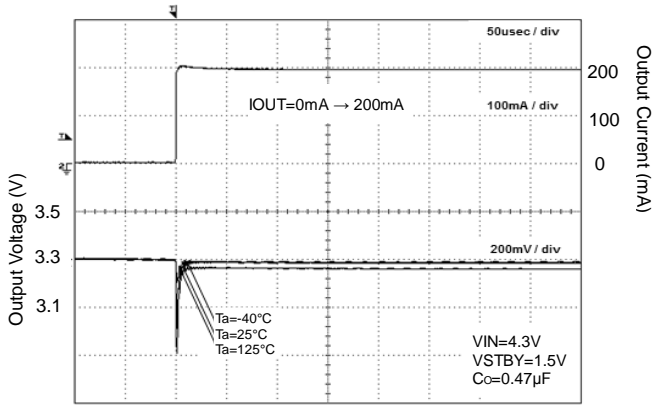

Figure 19. Load Response

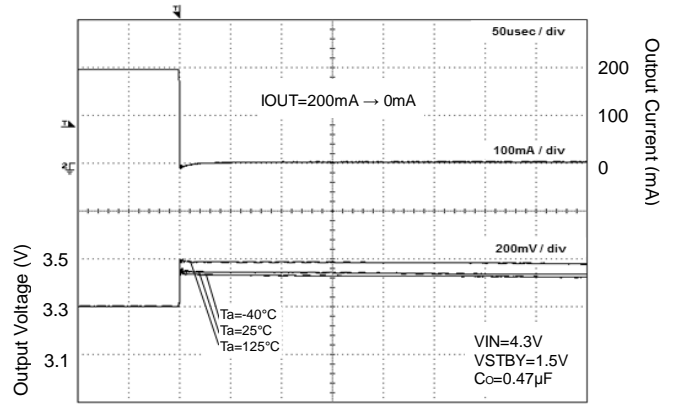

Figure 20. Load Response

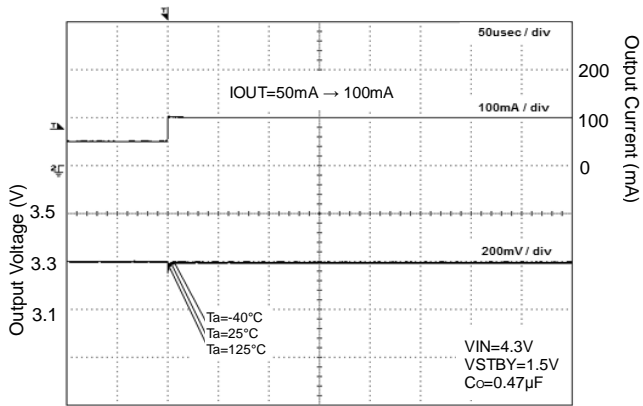

Figure 21. Load Response

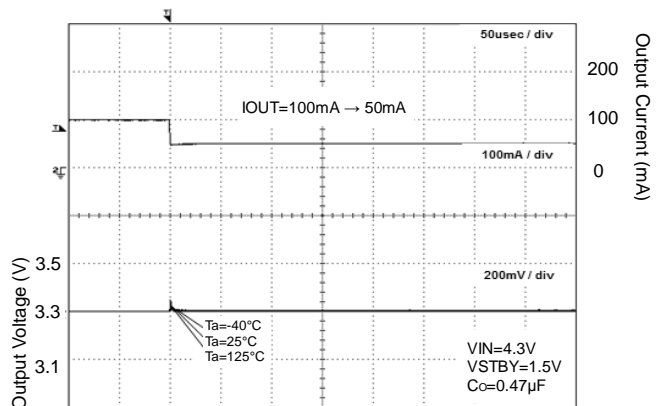

Figure 22. Load Response

Reference data BU33JA2MNVX-C (Ta=25°C unless otherwise specified.)

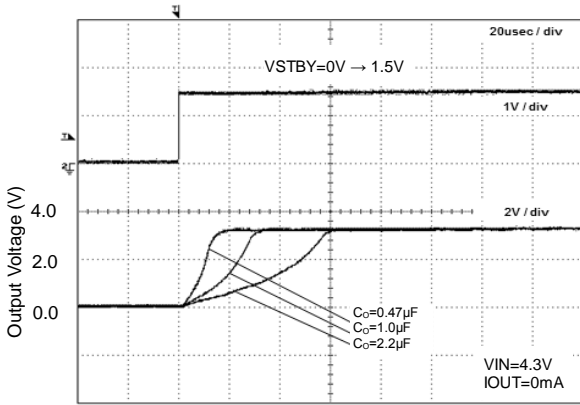

Figure 23. Start Up Time
IOUT=0mA

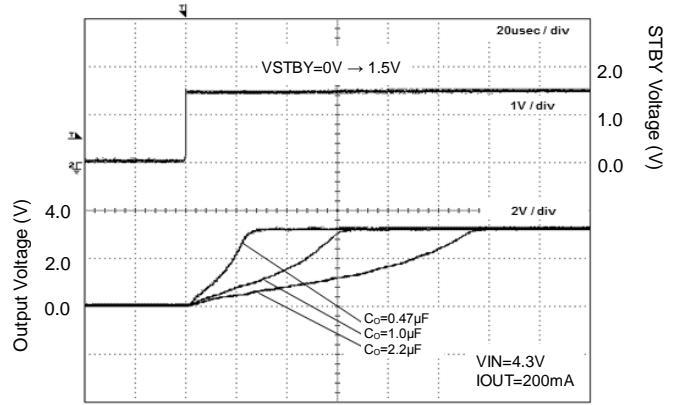

Figure 24. Start Up Time
IOUT=200mA

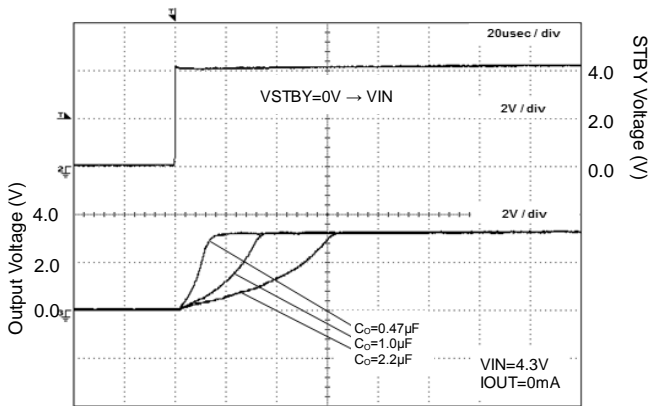

Figure 25. Start Up Time
(VIN=STBY) IOUT=0mA

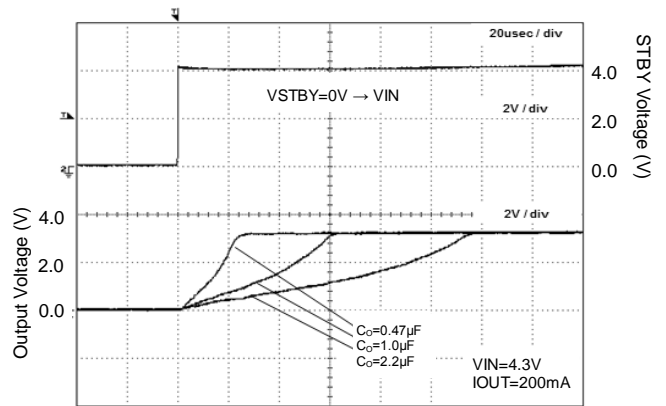
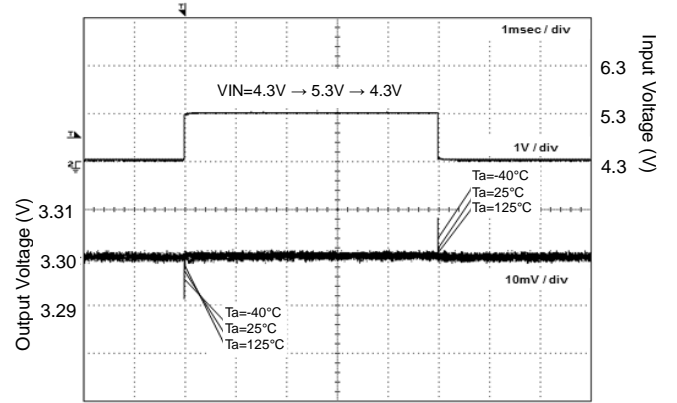
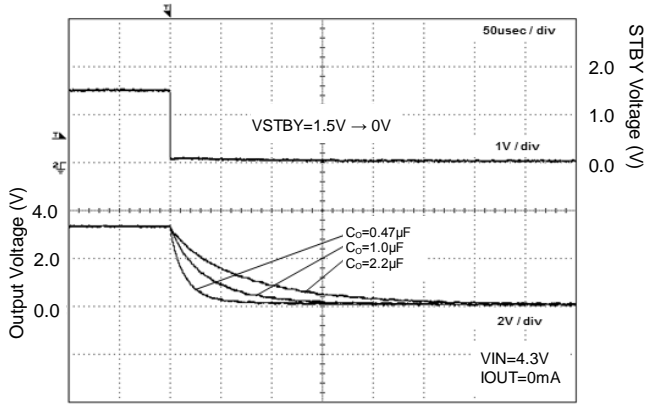

Figure 26. Start Up Time
(VIN=STBY) IOUT=200mA

Reference data BU33JA2MNVX-C (Ta=25°C unless otherwise specified.)



Power Dissipation

SSON004R1010

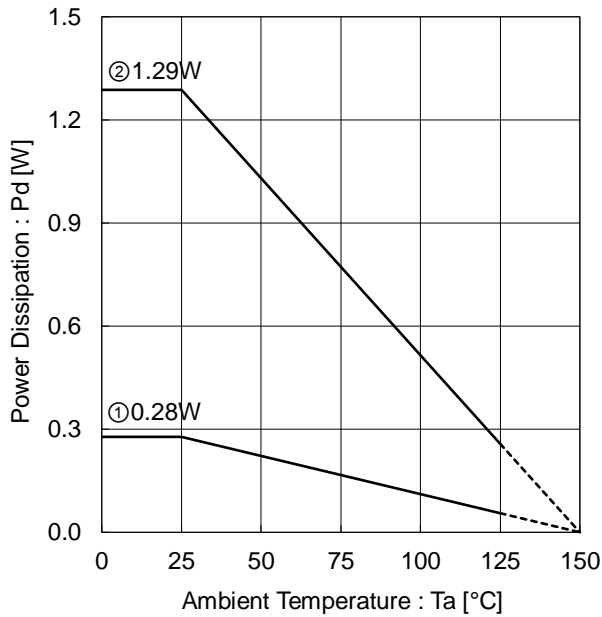

Figure 29. SSON004R1010 Package Data (Reference Data)

IC mounted on ROHM standard board based on JEDEC.

- ① : 1-layer PCB
 (Copper foil area on the reverse side of PCB: 0 mm × 0 mm)
 Board material: FR4
 Board size: 114.3 mm × 76.2 mm × 1.57 mmt
 Mount condition: PCB and exposed pad are soldered.
 Top copper foil: ROHM recommended footprint + wiring to measure, 2 oz. copper.
- ② : 4-layer PCB
 (2 inner layers copper foil area of PCB, copper foil area on the reverse side of PCB: 74.2 mm × 74.2 mm)
 Board material: FR4
 Board size: 114.3 mm × 76.2 mm × 1.6 mmt
 Mount condition: PCB and exposed pad are soldered.
 Top copper foil: ROHM recommended footprint + wiring to measure, 2 oz. copper.
 2 inner layers copper foil area of PCB : 74.2 mm × 74.2 mm, 1 oz. copper.
 Copper foil area on the reverse side of PCB : 74.2 mm × 74.2 mm, 2 oz. copper.

Condition① : $\theta_{JA} = 450.2 \text{ }^\circ\text{C/W}$, $\Psi_{JT} \text{ (top center)} = 99 \text{ }^\circ\text{C/W}$

Condition② : $\theta_{JA} = 97.1 \text{ }^\circ\text{C/W}$, $\Psi_{JT} \text{ (top center)} = 22 \text{ }^\circ\text{C/W}$

Thermal Design

Within this IC, the power consumption is decided by the dropout voltage condition, the load current and the circuit current. Refer to power dissipation curves illustrated in Figure 29 when using the IC in an environment of $T_a \geq 25\text{ }^\circ\text{C}$. Even if the ambient temperature T_a is at $25\text{ }^\circ\text{C}$, depending on the input voltage and the load current, chip junction temperature can be very high. Consider the design to be $T_j \leq T_{jmax} = 150\text{ }^\circ\text{C}$ in all possible operating temperature range.

Should by any condition the maximum junction temperature $T_{jmax} = 150\text{ }^\circ\text{C}$ rating be exceeded by the temperature increase of the chip, it may result in deterioration of the properties of the chip. The thermal impedance in this specification is based on recommended PCB and measurement condition by JEDEC standard. Verify the application and allow sufficient margins in the thermal design by the following method is used to calculate the junction temperature T_j .

T_j can be calculated by either of the two following methods.

1. The following method is used to calculate the junction temperature T_j .

$$T_j = T_a + P_C \times \theta_{JA}$$

Where:

T_j : Junction Temperature
 T_a : Ambient Temperature
 P_C : Power Consumption
 θ_{JA} : Thermal Impedance
 (Junction to Ambient)

2. The following method is also used to calculate the junction temperature T_j .

$$T_j = T_T + P_C \times \Psi_{JT}$$

Where:

T_j : Junction Temperature
 T_T : Top Center of Case's (mold) Temperature
 P_C : Power consumption
 Ψ_{JT} : Thermal Impedance
 (Junction to Top Center of Case)

The following method is used to calculate the power consumption P_C (W).

$$P_C = (V_{IN} - V_{OUT}) \times I_{OUT} + V_{IN} \times I_{GND}$$

Where:

P_C : Power Consumption
 V_{IN} : Input Voltage
 V_{OUT} : Output Voltage
 I_{OUT} : Load Current
 I_{GND} : Circuit Current

• Calculation Example (SSON004R1010)

If $V_{IN} = 3.0\text{ V}$, $V_{OUT} = 1.8\text{ V}$, $I_{OUT} = 50\text{ mA}$, $I_{GND} = 35\text{ }\mu\text{A}$, the power consumption P_C can be calculated as follows:

$$\begin{aligned} P_C &= (V_{IN} - V_{OUT}) \times I_{OUT} + V_{IN} \times I_{GND} \\ &= (3.0\text{ V} - 1.8\text{ V}) \times 50\text{ mA} + 3.0\text{ V} \times 35\text{ }\mu\text{A} \\ &= 0.06\text{ W} \end{aligned}$$

At the ambient temperature $T_{max} = 125^\circ\text{C}$, the thermal Impedance (Junction to Ambient) $\theta_{JA} = 97.1\text{ }^\circ\text{C/W}$ (4-layer PCB),

$$\begin{aligned} T_j &= T_{max} + P_C \times \theta_{JA} \\ &= 125\text{ }^\circ\text{C} + 0.06\text{ W} \times 97.1\text{ }^\circ\text{C/W} \\ &= 130.8\text{ }^\circ\text{C} \end{aligned}$$

When operating the IC, the top center of case's (mold) temperature $T_T = 100\text{ }^\circ\text{C}$, $\Psi_{JT} = 22\text{ }^\circ\text{C/W}$ (4-layer PCB),

$$\begin{aligned} T_j &= T_T + P_C \times \Psi_{JT} \\ &= 100\text{ }^\circ\text{C} + 0.06\text{ W} \times 22\text{ }^\circ\text{C/W} \\ &= 101.3\text{ }^\circ\text{C} \end{aligned}$$

For optimum thermal performance, it is recommended to expand the copper foil area of the board, increasing the layer and thermal via between thermal land pad.

Linear Regulators Surge Voltage Protection

The following provides instructions on surge voltage overs absolute maximum ratings polarity protection for ICs.

1. Applying positive surge to the input

If the possibility exists that surges higher than absolute maximum ratings 6.5 V will be applied to the input, a Zener Diode should be placed to protect the device in between the V_{IN} and the GND as shown in the figure 30.

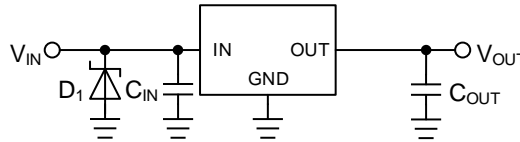

Figure 30. Surges Higher than 6.5 V will be Applied to the Input

2. Applying negative surge to the input

If the possibility exists that surges lower than absolute maximum ratings -0.3 V will be applied to the input, a Schottky Diode should be placed to protect the device in between the V_{IN} and the GND as shown in the figure 31.

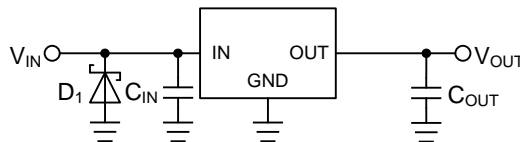

Figure 31. Surges Lower than -0.3 V will be Applied to the Input

Linear Regulators Reverse Voltage Protection

A linear regulator integrated circuit (IC) requires that the input voltage is always higher than the regulated voltage. Output voltage, however, may become higher than the input voltage under specific situations or circuit configurations, and that reverse voltage and current may cause damage to the IC. A reverse polarity connection or certain inductor components can also cause a polarity reversal between the input and output pins. The following provides instructions on reversed voltage polarity protection for ICs.

1. about Input /Output Voltage Reversal

In an MOS linear regulator, a parasitic element exists as a body diode in the drain-source junction portion of its power MOSFET. Reverse input/output voltage triggers the current flow from the output to the input through the body diode. The inverted current may damage or destroy the semiconductor elements of the regulator since the effect of the parasitic body diode is usually disregarded for the regulator behavior (Figure 32).

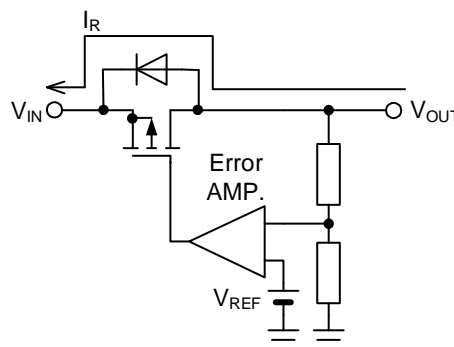

Figure 32. Reverse Current Path in an MOS Linear Regulator

An effective solution to this is an external bypass diode connected in-between the input and output to prevent the reverse current flow inside the IC (see Figure 33). Note that the bypass diode must be turned on before the internal circuit of the IC. Bypass diodes in the internal circuits of MOS linear regulators must have low forward voltage V_F . Some ICs are configured with current-limit thresholds to shut down high reverse current even when the output is off, allowing large leakage current from the diode to flow from the input to the output; therefore, it is necessary to choose one that has a small reverse current. Specifically, select a diode with a rated peak inverse voltage greater than the input to output voltage differential and rated forward current greater than the reverse current during use.

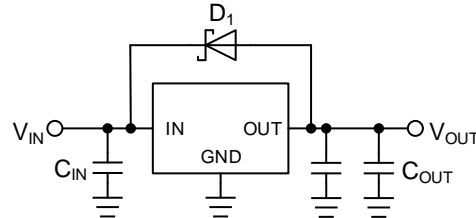

Figure 33. Bypass Diode for Reverse Current Diversion

The lower forward voltage (V_F) of Schottky barrier diodes cater to requirements of MOS linear regulators, however the main drawback is found in the level of their reverse current (I_R), which is relatively high. So, one with a low reverse current is recommended when choosing a Schottky diode. The V_R - I_R characteristics versus temperatures show increases at higher temperatures.

If V_{IN} is open in a circuit as shown in the following Figure 34 with its input/output voltage being reversed, the only current that flows in the reverse current path is the bias current of the IC. Because the amperage is too low to damage or destroy the parasitic element, a reverse current bypass diode is not required for this type of circuit.

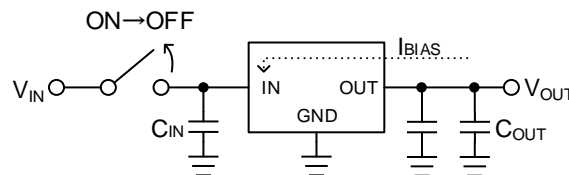

Figure 34. Open V_{IN}

2. Protection against Input Reverse Voltage

Accidental reverse polarity at the input connection flows a large current to the diode for electrostatic breakdown protection between the input pin of the IC and the GND pin, which may destroy the IC (see Figure 35).

A Schottky barrier diode or rectifier diode connected in series with the power supply as shown in Figure 36 is the simplest solution to prevent this from happening. The solution, however, is unsuitable for a circuit powered by batteries because there is a power loss calculated as $V_F \times I_{OUT}$, as the forward voltage V_F of the diode drops in a correct connection. The lower V_F of a Schottky barrier diode than that of a rectifier diode gives a slightly smaller power loss. Because diodes generate heat, care must be taken to select a diode that has enough allowance in power dissipation. A reverse connection allows a negligible reverse current to flow in the diode.

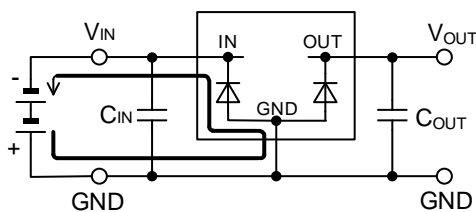

Figure 35. Current Path in Reverse Input Connection

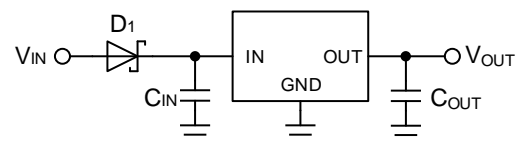

Figure 36. Protection against Reverse Polarity 1

Figure 37 shows a circuit in which a P-channel MOSFET is connected in series with the power. The diode located in the drain-source junction portion of the MOSFET is a body diode (parasitic element). The voltage drop in a correct connection is calculated by multiplying the resistance of the MOSFET being turned on by the output current I_{OUT} , therefore it is smaller than the voltage drop by the diode (see Figure 36) and results in less of a power loss. No current flows in a reverse connection where the MOSFET remains off.

If the voltage taking account of derating is greater than the voltage rating of MOSFET gate-source junction, lower the gate-source junction voltage by connecting voltage dividing resistors as shown in Figure 38.

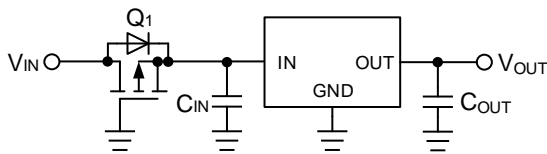

Figure 37. Protection against Reverse Polarity 2

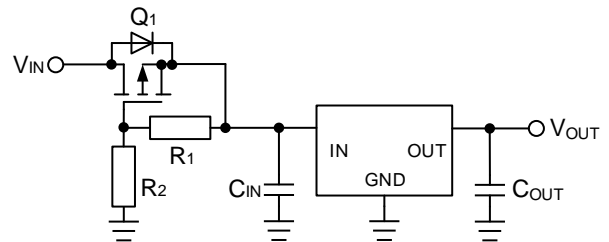

Figure 38. Protection against Reverse Polarity 3

3. Protection against Output Reverse Voltage when Output Connect to an Inductor

If the output load is inductive, electrical energy accumulated in the inductive load is released to the ground upon the output voltage turning off. In-between the IC output and ground pins is a diode for preventing electrostatic breakdown, in which a large current flows that could destroy the IC. To prevent this from happening, connect a Schottky barrier diode in parallel with the diode (see Figure 39).

Further, if a long wire is in use for the connection between the output pin of the IC and the load, observe the waveform on an oscilloscope, since it is possible that the load becomes inductive. An additional diode is needed for a motor load that is affected by its counter electromotive force, as it produces an electrical current in a similar way.

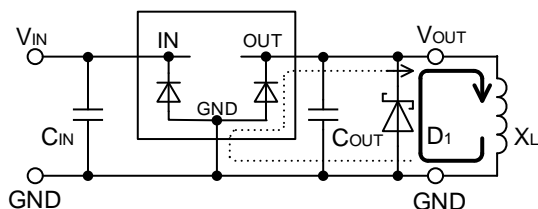

Figure 39. Current Path in Inductive Load (Output: Off)

Operation Notes

1. Absolute maximum ratings

Use of the IC exceeding the absolute maximum ratings (such as the input voltage or operating temperature range) may result in damage to the IC. Damage mode of the IC in such case cannot be assumed (e.g. short mode or open mode). If operational values are expected to exceed the maximum ratings for the device, consider adding protective circuitry (such as fuses) to eliminate the risk of damaging the IC.

2. GND potential

The potential of the GND pin must be the minimum potential in the system in all operating conditions. Never connect a potential lower than GND to any pin, even if only transiently.

3. Thermal design

Use a thermal design which ensure sufficient margin to the power dissipation rating (Pd) under actual operating conditions.

4. Inter-pin shorts and mounting errors

Caution on the orientation and positioning of the IC for mounting on printed circuit boards. Improper mounting or shorts between pins may result in damage to the IC.

5. Common impedance

Wiring traces should be as short and wide as possible to minimize common impedance. Bypass capacitors should be use to keep ripple to a minimum.

6. Voltage of STBY pin

To enable standby mode for all channels, set the STBY pin to 0.3 V or less, and for normal operation, to 1.2 V or more. Setting STBY to a voltage between 0.3 and 1.2 V may cause malfunction and should be avoided. Keep transition time between high and low (or vice versa) to a minimum.

Additionally, if STBY is shorted to VIN, the IC will switch to standby mode and disable the output discharge circuit, causing a temporary voltage to remain on the output pin. If the IC is switched on again while this voltage is present, overshoot may occur on the output. Therefore, in applications where these pins are shorted, the output should always be completely discharged before turning the IC on.

7. Over-current protection circuit (OCP)

This IC features an integrated over-current and short-protection circuitry on the output to prevent destruction of the IC when the output is shorted. The OCP circuitry is designed only to protect the IC from irregular conditions (such as motor output shorts) and is not designed to be used as an active security device for the application. Therefore, applications should not be designed under the assumption that this circuitry will engage.

8. Thermal shutdown circuit (TSD)

This IC also features a thermal shutdown circuit that is designed to turn the output off when the junction temperature of the IC exceeds approximately 150°C. This feature is intended to protect the IC only in the event of thermal overload and is not designed to guarantee operation or act as an active security device for the application. Therefore, applications should not be designed under the assumption that this circuitry will engage.

9. Input/output capacitor

Capacitors must be connected between the input/output pins and GND for stable operation, and should be physically mounted as close to the IC pins as possible. The input capacitor helps to counteract increases in power supply impedance, and increases stability in applications with long or winding power supply traces. The output capacitance value is directly related to the overall stability and transient response of the regulator, and should be set to the largest possible value for the application to increase these characteristics. During design, keep in mind that in general, ceramic capacitors have a wide range of tolerances, temperature coefficients and DC bias characteristics, and that their capacitance values tend to decrease over time. Confirm these details before choosing appropriate capacitors for your application. (Refer to the technical note of the intended ceramic capacitors.)

10. About the equivalent series resistance (ESR) of a ceramic capacitor

Capacitors generally have ESR (equivalent series resistance) and it operates stably in the ESR-IOUT area shown on the below. Since ceramic capacitors, tantalum capacitors, electrolytic capacitors, etc. generally have different ESR, please check the ESR of the capacitor to be used and use it within the stability area range shown in the right graph for evaluation of the actual application.

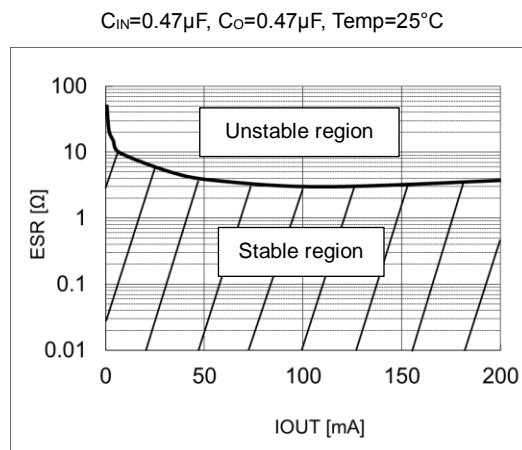

Figure 40. Stable region

Input/Output Capacitor

It is recommended that an input capacitor is placed near pins between the VIN pin and GND as well as an output capacitor between the VOUT pin and GND. The input is valid when the power supply impedance is high or when the PCB trace has significant length. For the output capacitor, the greater the capacitance, the more stable the output will be depending on the load and line voltage variations. However, please check the actual functionality of this capacitor by mounting it on a board for the actual application. Ceramic capacitors usually have different, thermal and equivalent series resistance characteristics, and may degrade gradually over continued use. For additional details, please check with the manufacturer, and select the best ceramic capacitor for your application.

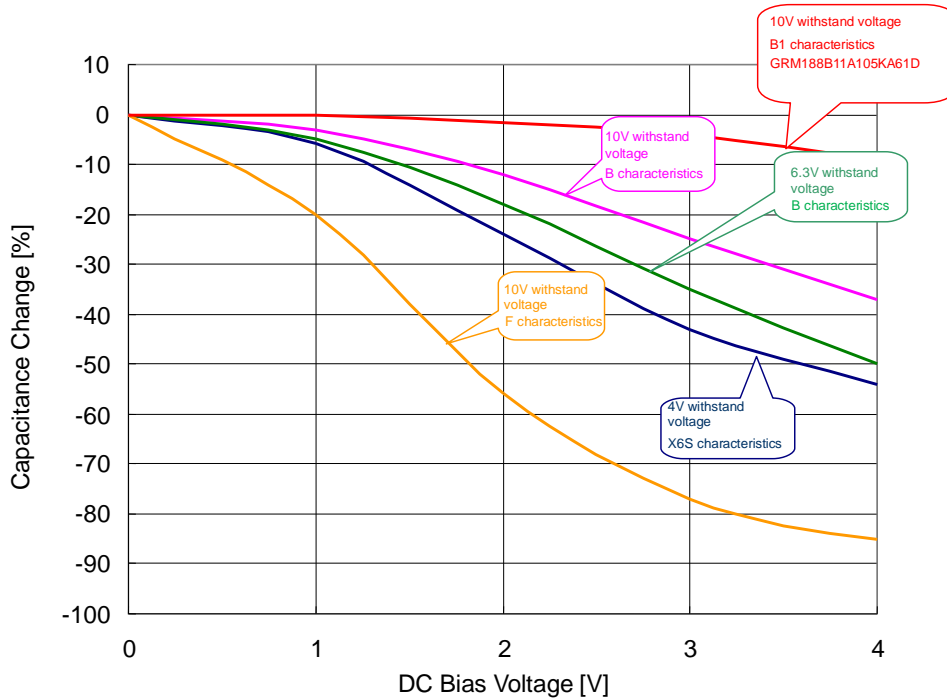

Figure 41. Capacity-bias characteristics (Characteristics Example)

I/O Equivalence Circuits

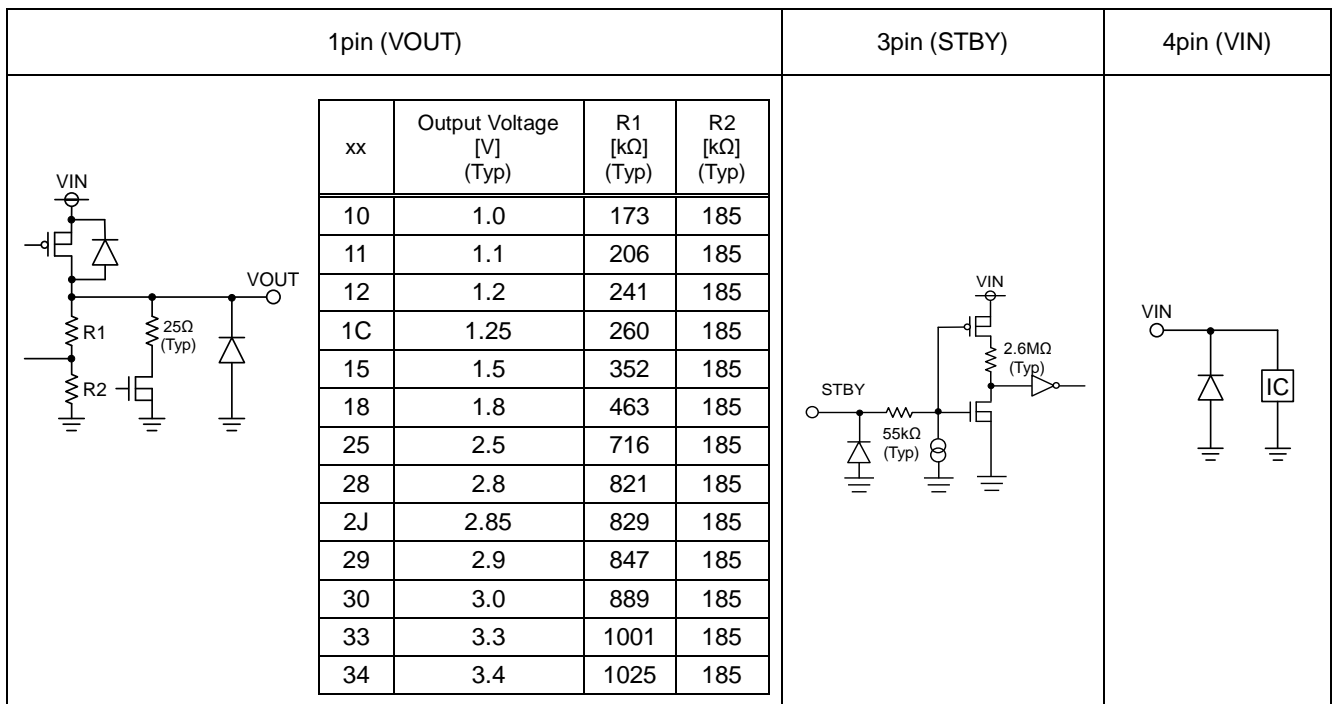
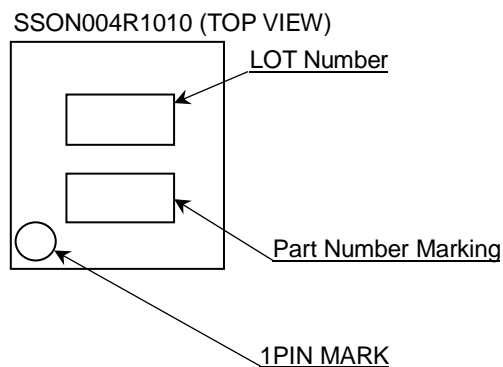

Figure 42. Input / Output equivalent circuit

Marking Diagram



| Part Number | Output Voltage [V] | Part Number Marking |
|---------------|--------------------|---------------------|
| BU10JA2MNVX-C | 1.0 | 5 |
| BU11JA2MNVX-C | 1.1 | 6 |
| BU12JA2MNVX-C | 1.2 | 4 |
| BU1CJA2MNVX-C | 1.25 | 3 |
| BU15JA2MNVX-C | 1.5 | 2 |
| BU18JA2MNVX-C | 1.8 | Q |
| BU25JA2MNVX-C | 2.5 | 1 |
| BU28JA2MNVX-C | 2.8 | U |
| BU2JJA2MNVX-C | 2.85 | 0 |
| BU29JA2MNVX-C | 2.9 | Ui |
| BU30JA2MNVX-C | 3.0 | Y |
| BU33JA2MNVX-C | 3.3 | R |
| BU34JA2MNVX-C | 3.4 | Yi |

Physical Dimension and Packing Information

| | |
|--------------|--------------|
| Package Name | SSON004R1010 |
|--------------|--------------|

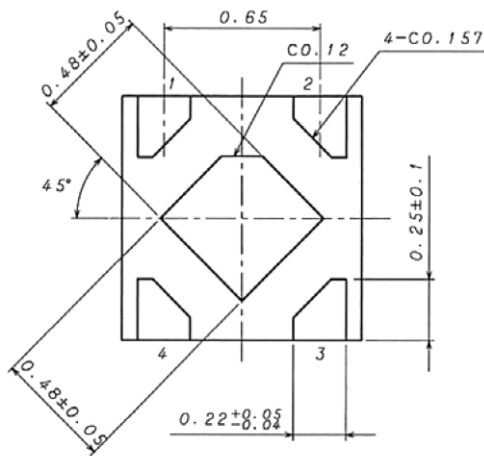
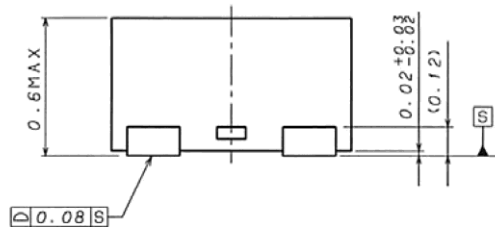
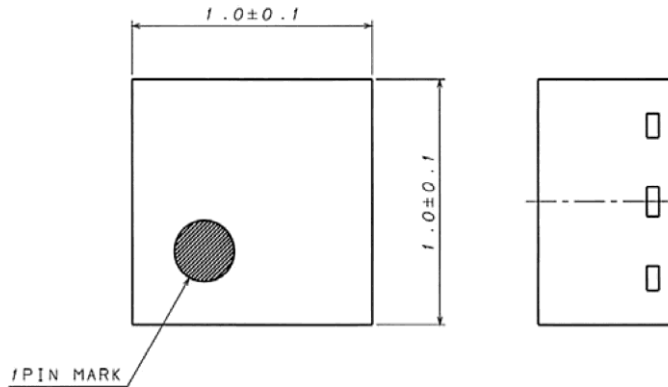

(UNIT : mm)
 PKG : SSON004R1010
 Drawing No. EX077-5001

< Tape and Reel Information >

| | |
|-------------------|--|
| Tape | Embossed carrier tape |
| Quantity | 5000pcs |
| Direction of feed | TL The direction is the pin 1 of product is at the lower left when you hold reel on the left hand and you pull out the tape on the right hand |

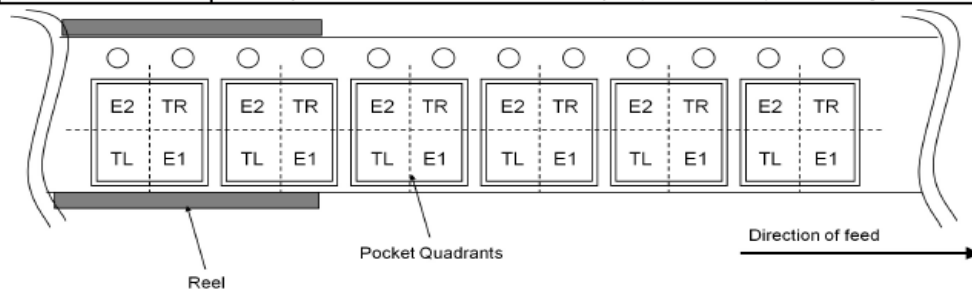

Revision History

| Date | Revision | Changes |
|---------------|----------|---|
| 26.Dec.2014 | 001 | New Release. |
| 27.Aug.2015 | 002 | P2 Add Lineup. |
| 11.Apr.2016 | 003 | Applied the ROHM Standard Style and improved understandability. Add Equivalence Circuits. |
| 21.Mar.2017 | 004 | p.1-20 Update of the footer. (Applied the rule.) p.2 The voltage lineup is added. (Output Voltage:1.1V) p.4 Changed the expression from "Power dissipation" to "Thermal Resistance". (Based on the JEDEC standard) p.5 Temperature condition of "Electrical Characteristics" is added. Changed the expression from "Operating Current" to "Circuit Current". p.8 Unified the item name of figure 14 for the parameter name of "Electrical Characteristics". p.13 Changed the expression from "About power dissipation(Pd)" to "Power Dissipation". (Based on the change of p.4) p.14 The item of "Thermal Design" is added. (Based on the change of p.4) p.15 The item of "Calculation Example(SSON004R1010)" is added. (Based on the change of p.4) p.17 Item of VIN is added in I/O Equivalence Circuits and resistance value is listed in I/O Equivalence Circuits. p.18 The lineup of "Marking Diagram" is added. (Output Voltage:1.1V) p.19 Update "Physical Dimension Tape and Reel Information" to the latest version. |
| 12. Mar. 2018 | 005 | p.2 Add Lineup. Added the electrode position of the back side to "Pin Configurations" in a dashed line. p.16-18 Added of the operation notes about the use of general linear regulator. p.20 Add Lineup p.21 Add Lineup |
| 9. Jul. 2018 | 006 | p.2 Add Lineup p.5 Correction of conditions errors in Ripple Rejection Ratio. p.20 Add Lineup p.21 Add Lineup Others, correction of errors. |

Notice

Precaution on using ROHM Products

1. If you intend to use our Products in devices requiring extremely high reliability (such as medical equipment ^(Note 1), aircraft/spacecraft, nuclear power controllers, etc.) and whose malfunction or failure may cause loss of human life, bodily injury or serious damage to property ("Specific Applications"), please consult with the ROHM sales representative in advance. Unless otherwise agreed in writing by ROHM in advance, ROHM shall not be in any way responsible or liable for any damages, expenses or losses incurred by you or third parties arising from the use of any ROHM's Products for Specific Applications.

(Note1) Medical Equipment Classification of the Specific Applications

| JAPAN | USA | EU | CHINA |
|-----------|-----------|------------|-----------|
| CLASS III | CLASS III | CLASS II b | CLASS III |
| CLASS IV | | CLASS III | |

2. ROHM designs and manufactures its Products subject to strict quality control system. However, semiconductor products can fail or malfunction at a certain rate. Please be sure to implement, at your own responsibilities, adequate safety measures including but not limited to fail-safe design against the physical injury, damage to any property, which a failure or malfunction of our Products may cause. The following are examples of safety measures:
 - [a] Installation of protection circuits or other protective devices to improve system safety
 - [b] Installation of redundant circuits to reduce the impact of single or multiple circuit failure
3. Our Products are not designed under any special or extraordinary environments or conditions, as exemplified below. Accordingly, ROHM shall not be in any way responsible or liable for any damages, expenses or losses arising from the use of any ROHM's Products under any special or extraordinary environments or conditions. If you intend to use our Products under any special or extraordinary environments or conditions (as exemplified below), your independent verification and confirmation of product performance, reliability, etc. prior to use, must be necessary:
 - [a] Use of our Products in any types of liquid, including water, oils, chemicals, and organic solvents
 - [b] Use of our Products outdoors or in places where the Products are exposed to direct sunlight or dust
 - [c] Use of our Products in places where the Products are exposed to sea wind or corrosive gases, including Cl₂, H₂S, NH₃, SO₂, and NO₂
 - [d] Use of our Products in places where the Products are exposed to static electricity or electromagnetic waves
 - [e] Use of our Products in proximity to heat-producing components, plastic cords, or other flammable items
 - [f] Sealing or coating our Products with resin or other coating materials
 - [g] Use of our Products without cleaning residue of flux (even if you use no-clean type fluxes, cleaning residue of flux is recommended); or Washing our Products by using water or water-soluble cleaning agents for cleaning residue after soldering
 - [h] Use of the Products in places subject to dew condensation
4. The Products are not subject to radiation-proof design.
5. Please verify and confirm characteristics of the final or mounted products in using the Products.
6. In particular, if a transient load (a large amount of load applied in a short period of time, such as pulse. is applied, confirmation of performance characteristics after on-board mounting is strongly recommended. Avoid applying power exceeding normal rated power; exceeding the power rating under steady-state loading condition may negatively affect product performance and reliability.
7. De-rate Power Dissipation depending on ambient temperature. When used in sealed area, confirm that it is the use in the range that does not exceed the maximum junction temperature.
8. Confirm that operation temperature is within the specified range described in the product specification.
9. ROHM shall not be in any way responsible or liable for failure induced under deviant condition from what is defined in this document.

Precaution for Mounting / Circuit board design

1. When a highly active halogenous (chlorine, bromine, etc.) flux is used, the residue of flux may negatively affect product performance and reliability.
2. In principle, the reflow soldering method must be used on a surface-mount products, the flow soldering method must be used on a through hole mount products. If the flow soldering method is preferred on a surface-mount products, please consult with the ROHM representative in advance.

For details, please refer to ROHM Mounting specification

Precautions Regarding Application Examples and External Circuits

1. If change is made to the constant of an external circuit, please allow a sufficient margin considering variations of the characteristics of the Products and external components, including transient characteristics, as well as static characteristics.
2. You agree that application notes, reference designs, and associated data and information contained in this document are presented only as guidance for Products use. Therefore, in case you use such information, you are solely responsible for it and you must exercise your own independent verification and judgment in the use of such information contained in this document. ROHM shall not be in any way responsible or liable for any damages, expenses or losses incurred by you or third parties arising from the use of such information.

Precaution for Electrostatic

This Product is electrostatic sensitive product, which may be damaged due to electrostatic discharge. Please take proper caution in your manufacturing process and storage so that voltage exceeding the Products maximum rating will not be applied to Products. Please take special care under dry condition (e.g. Grounding of human body / equipment / solder iron, isolation from charged objects, setting of Ionizer, friction prevention and temperature / humidity control).

Precaution for Storage / Transportation

1. Product performance and soldered connections may deteriorate if the Products are stored in the places where:
 - [a] the Products are exposed to sea winds or corrosive gases, including Cl₂, H₂S, NH₃, SO₂, and NO₂
 - [b] the temperature or humidity exceeds those recommended by ROHM
 - [c] the Products are exposed to direct sunshine or condensation
 - [d] the Products are exposed to high Electrostatic
2. Even under ROHM recommended storage condition, solderability of products out of recommended storage time period may be degraded. It is strongly recommended to confirm solderability before using Products of which storage time is exceeding the recommended storage time period.
3. Store / transport cartons in the correct direction, which is indicated on a carton with a symbol. Otherwise bent leads may occur due to excessive stress applied when dropping of a carton.
4. Use Products within the specified time after opening a humidity barrier bag. Baking is required before using Products of which storage time is exceeding the recommended storage time period.

Precaution for Product Label

A two-dimensional barcode printed on ROHM Products label is for ROHM's internal use only.

Precaution for Disposition

When disposing Products please dispose them properly using an authorized industry waste company.

Precaution for Foreign Exchange and Foreign Trade act

Since concerned goods might be fallen under listed items of export control prescribed by Foreign exchange and Foreign trade act, please consult with ROHM in case of export.

Precaution Regarding Intellectual Property Rights

1. All information and data including but not limited to application example contained in this document is for reference only. ROHM does not warrant that foregoing information or data will not infringe any intellectual property rights or any other rights of any third party regarding such information or data.
2. ROHM shall not have any obligations where the claims, actions or demands arising from the combination of the Products with other articles such as components, circuits, systems or external equipment (including software).
3. No license, expressly or implied, is granted hereby under any intellectual property rights or other rights of ROHM or any third parties with respect to the Products or the information contained in this document. Provided, however, that ROHM will not assert its intellectual property rights or other rights against you or your customers to the extent necessary to manufacture or sell products containing the Products, subject to the terms and conditions herein.

Other Precaution

1. This document may not be reprinted or reproduced, in whole or in part, without prior written consent of ROHM.
2. The Products may not be disassembled, converted, modified, reproduced or otherwise changed without prior written consent of ROHM.
3. In no event shall you use in any way whatsoever the Products and the related technical information contained in the Products or this document for any military purposes, including but not limited to, the development of mass-destruction weapons.
4. The proper names of companies or products described in this document are trademarks or registered trademarks of ROHM, its affiliated companies or third parties.

General Precaution

1. Before you use our Products, you are requested to carefully read this document and fully understand its contents. ROHM shall not be in any way responsible or liable for failure, malfunction or accident arising from the use of any ROHM's Products against warning, caution or note contained in this document.
2. All information contained in this document is current as of the issuing date and subject to change without any prior notice. Before purchasing or using ROHM's Products, please confirm the latest information with a ROHM sales representative.
3. The information contained in this document is provided on an "as is" basis and ROHM does not warrant that all information contained in this document is accurate and/or error-free. ROHM shall not be in any way responsible or liable for any damages, expenses or losses incurred by you or third parties resulting from inaccuracy or errors of or concerning such information.