

PTS 830 Series Microminiature SMT Top Actuated



Features/Benefits

- 3.5 x 2.6 mm footprint
- High number of cycles
- Optional ground pin

Typical Applications

- Wearable electronics
- Nomad devices
- Remote controls
- Keyless entry system

Specifications

FUNCTION: momentary action
 CONTACT ARRANGEMENT: 1 make contact = SPST N.O.
 TERMINALS: G type for SMT
 TRAVEL: 0.15 mm ± 0.1 mm

	Operating Force (gf)	Life Cycles	Ground Pin
PTS830 GM140 SMTR LFS	160 ± 50	500,000	No
PTS830 GG140 SMTR LFS	450 ± 80	200,000	No
PTS830 GM140G SMTR LFS	160 ± 50	500,000	Yes
PTS830 GG140G SMTR LFS	450 ± 80	200,000	Yes

Packaging

Switches in reels of 9,500 pieces
 Dimensions of reels according to EIA 481B
 External diameter 330 mm

Electrical

MAXIMUM VOLTAGE: 12 VDC
 MAXIMUM CURRENT DC: 50 mA
 DIELECTRIC STRENGTH: 100 VA C (1mn)
 CONTACT RESISTANCE: ≤ 100 mΩ
 INSULATION RESISTANCE: ≥ 100 MΩ
 BOUNCE TIME: ≤ 10 ms

Environmental

OPERATING TEMPERATURE: -40°C to 85°C

Process

SOLDERING: This component is suited to the following methods:
 Infrared Reflow Soldering in accordance with IEC61760-1

NOTE: Specifications listed above are for switches with standard options.
 For information on specific and custom switches, consult Customer Service Center.

How To Order

Our easy build-a-switch concept allows you to mix and match options to create the switch you need. To order, select desired option from each category and place it in the appropriate box.

For any part number different from those listed above, please consult your local representative.

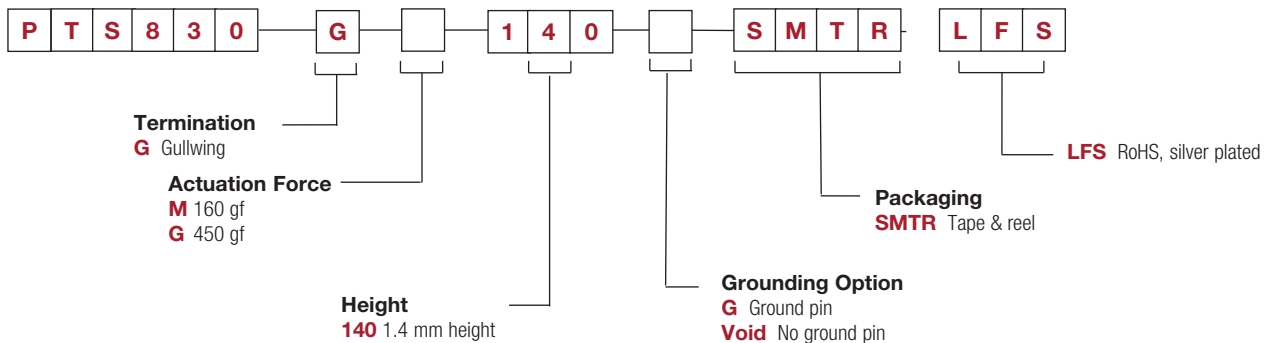

PTS 830 Series Microminiature SMT Top Actuated

PTS830 GX 140 SMTR LFS

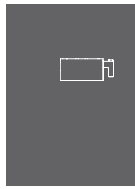

Tactile Switches

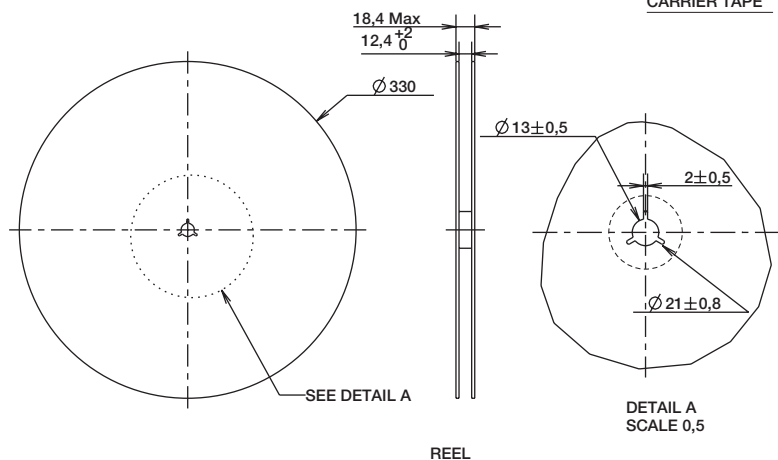
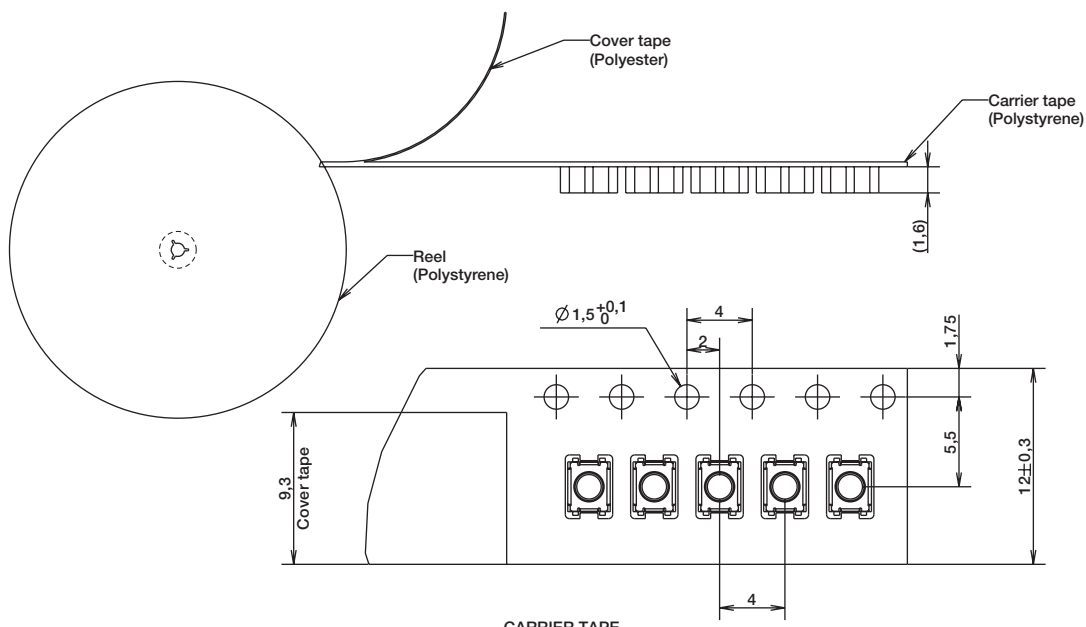
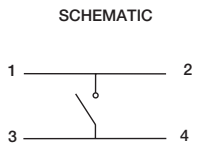
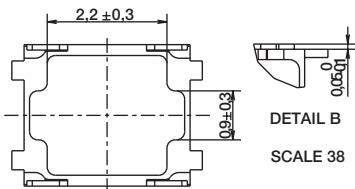
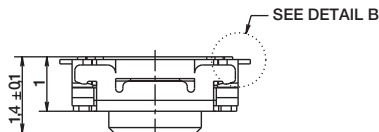
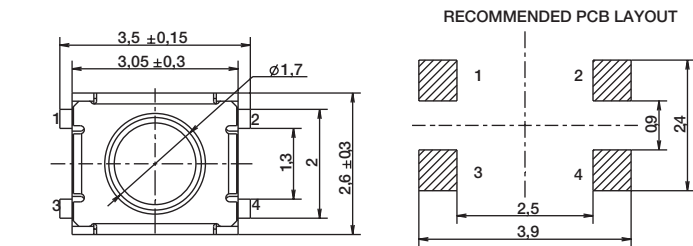

PTS 830 Series Microminiature SMT Top Actuated

PTS830 GX 140 G SMTR LFS

Tactile Switches

B

