

UMD6N Dual Digital Transistors (NPN+PNP)

FEATURES

- DTA143T(PNP) and DTC143T(NPN) transistors are built-in a package.
- Transistor elements are independent, eliminating interference.
- Mounting cost and area can be cut in half.

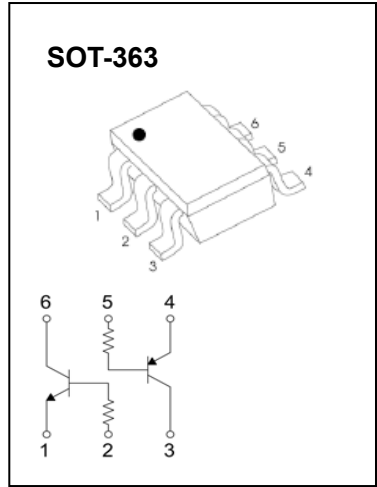

MARKING:D6

Absolute maximum ratings(Ta=25°C)

Parameter	Symbol	Limits	Unit
Collector-base voltage	$V_{(BR)CBO}$	50	V
Collector-emitter voltage	$V_{(BR)CEO}$	50	V
Emitter-base voltage	$V_{(BR)EBO}$	5	V
Collector current	I_C	100	mA
Collector Power dissipation	P_C	150	mW
Operation Junction and Storage Temperature Range	T_J, T_{stg}	-55~+150	°C

Electrical characteristics (Ta=25°C)

Parameter	Symbol	Min.	Typ	Max.	Unit	Conditions
Collector-base breakdown voltage	$V_{(BR)CBO}$	50			V	$I_C=50\mu A$
Collector-emitter breakdown voltage	$V_{(BR)CEO}$	50			V	$I_C=1mA$
Emitter-base breakdown voltage	$V_{(BR)EBO}$	5			V	$I_E=50\mu A$
Collector cut-off current	I_{CBO}			0.5	μA	$V_{CB}=50V$
Emitter cut-off current	I_{EBO}			0.5	μA	$V_{EB}=4V$
Collector-emitter saturation voltage	$V_{CE(sat)}$			0.3	V	$I_C=5mA, I_B=0.25mA$
DC current transfer ratio	h_{FE}	100		600		$V_{CE}=5V, I_C=1mA$
Input resistance	R_1	3.29	4.7	6.11	K Ω	
Transition frequency	f_T		250		MHz	$V_{CE}=10V, I_E=-5mA, f=100MHz$

Static Characteristic

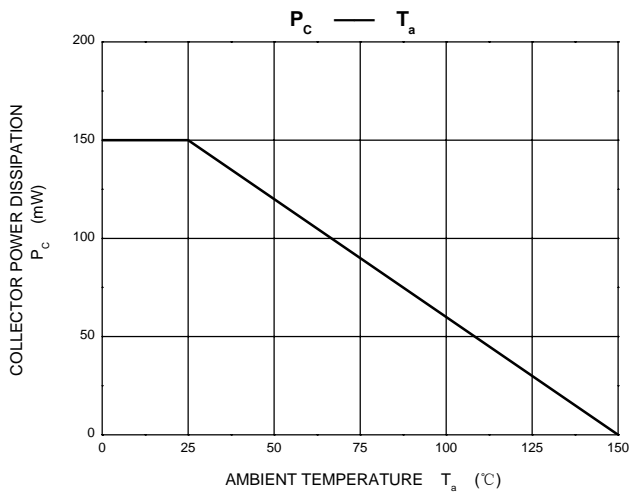
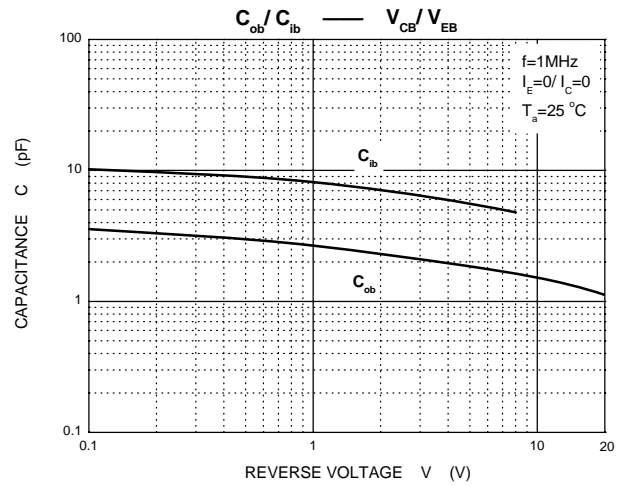
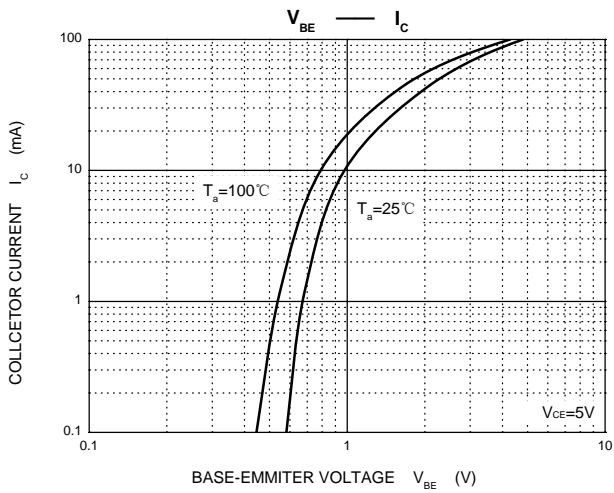
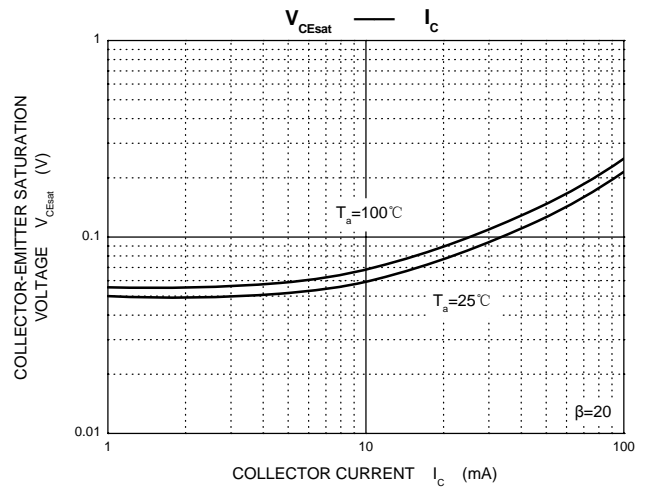
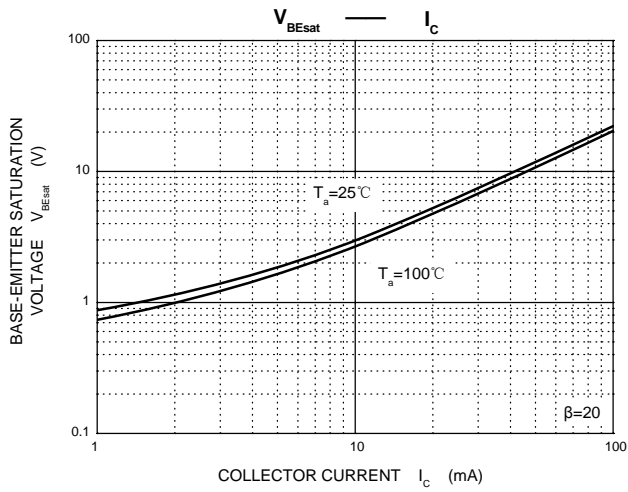
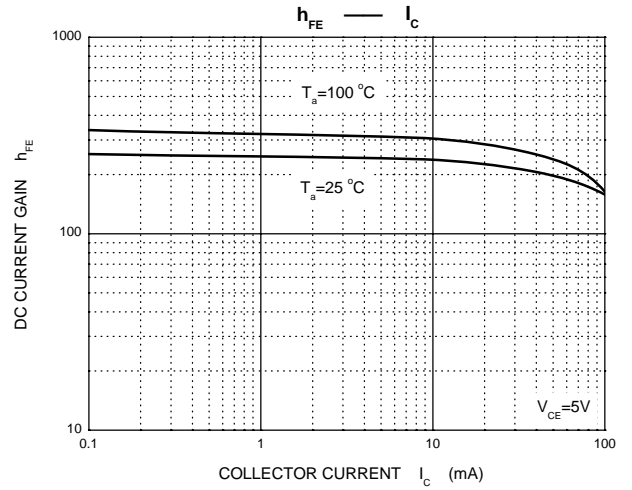
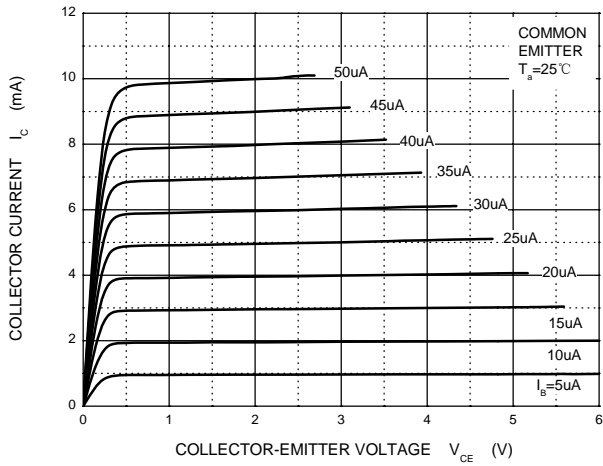

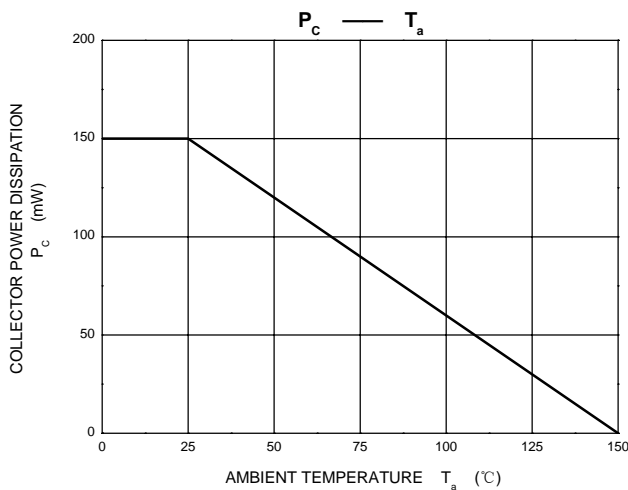
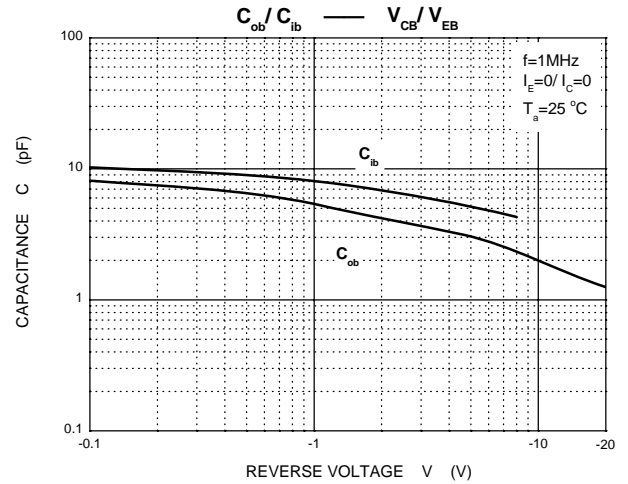
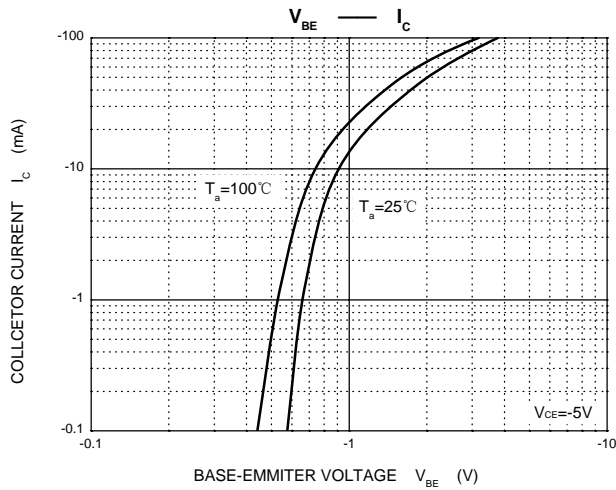
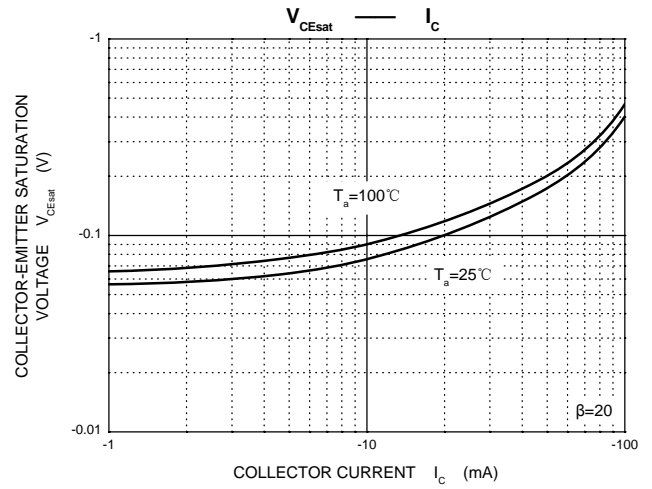
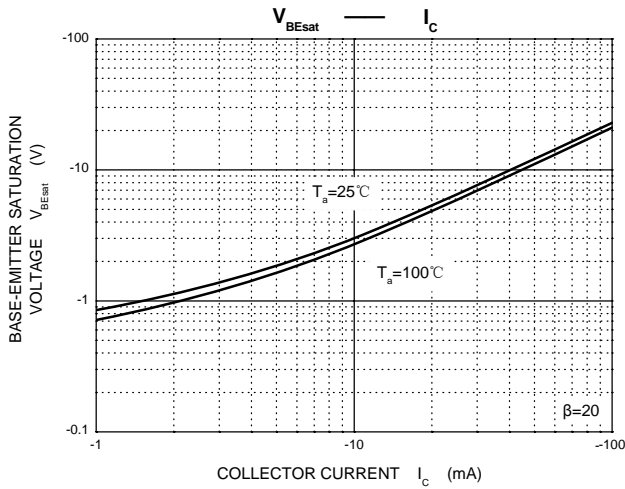
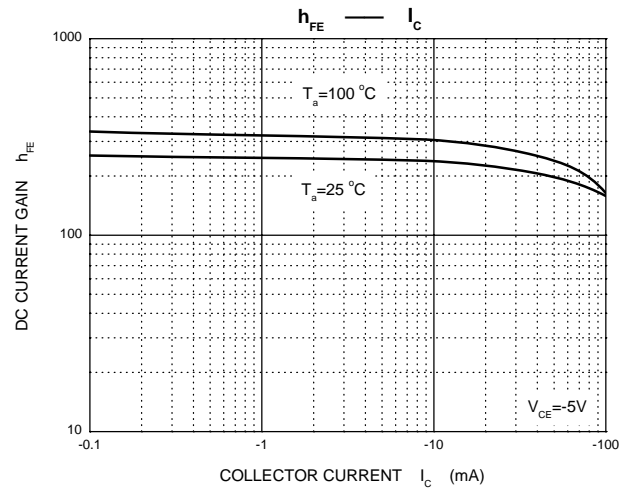
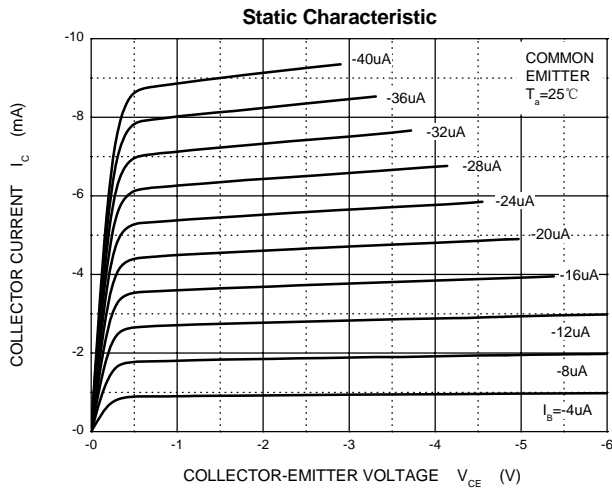

SOT-363 Package Outline Dimensions

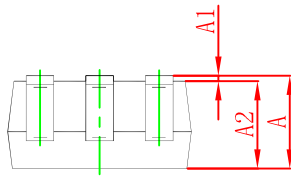
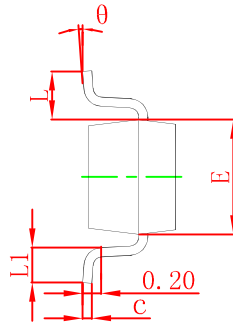
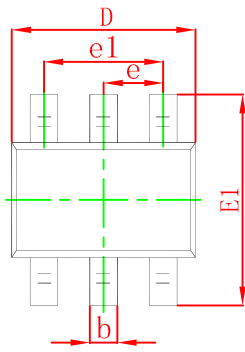

Symbol	Dimensions In Millimeters		Dimensions In Inches	
	Min	Max	Min	Max
A	0.900	1.100	0.035	0.043
A1	0.000	0.100	0.000	0.004
A2	0.900	1.000	0.035	0.039
b	0.150	0.350	0.006	0.014
c	0.100	0.150	0.004	0.006
D	2.000	2.200	0.079	0.087
E	1.150	1.350	0.045	0.053
E1	2.150	2.400	0.085	0.094
e	0.650 TYP		0.026 TYP	
e1	1.200	1.400	0.047	0.055
L	0.525 REF		0.021 REF	
L1	0.260	0.460	0.010	0.018
θ	0°	8°	0°	8°

SOT-363 Suggested Pad Layout

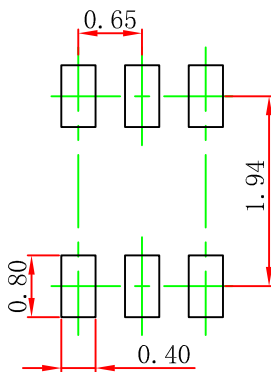

Note:

1. Controlling dimension: in millimeters.
2. General tolerance: $\pm 0.05\text{mm}$.
3. The pad layout is for reference purposes only.

NOTICE

JSCJ reserves the right to make modifications, enhancements, improvements, corrections or other changes without further notice to any product herein. JSCJ does not assume any liability arising out of the application or use of any product described herein.

SOT-363 Tape and Reel

SOT-363 Embossed Carrier Tape

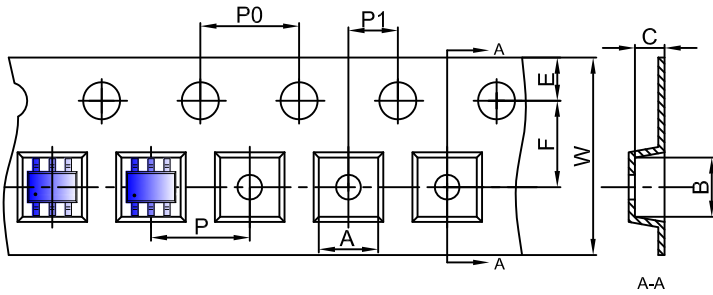

Packaging Description:

SOT-363 parts are shipped in tape. The carrier tape is made from a dissipative (carbon filled) polycarbonate resin. The cover tape is a multilayer film (Heat Activated Adhesive in nature) primarily composed of polyester film, adhesive layer, sealant, and anti-static sprayed agent. These reeled parts in standard option are shipped with 3,000 units per 7" or 17.8cm diameter reel. The reels are clear in color and is made of polystyrene plastic (anti-static coated).

Dimensions are in millimeter										
Pkg type	A	B	C	d	E	F	P0	P	P1	W
SOT-363	2.25	2.55	1.20	Ø1.50	1.75	3.50	4.00	4.00	2.00	8.00

SOT-363 Tape Leader and Trailer

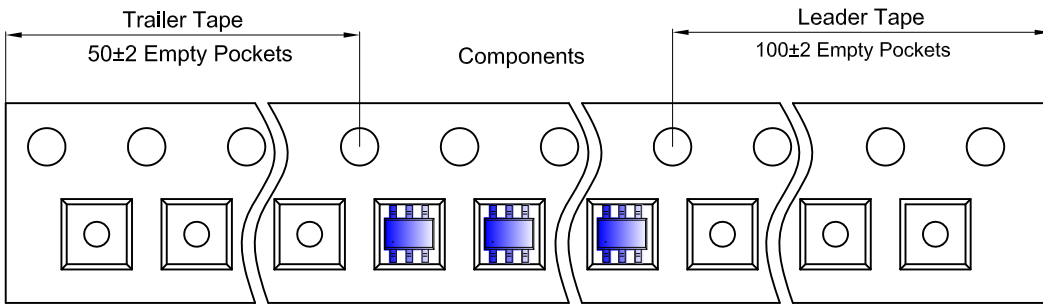

SOT-363 Reel

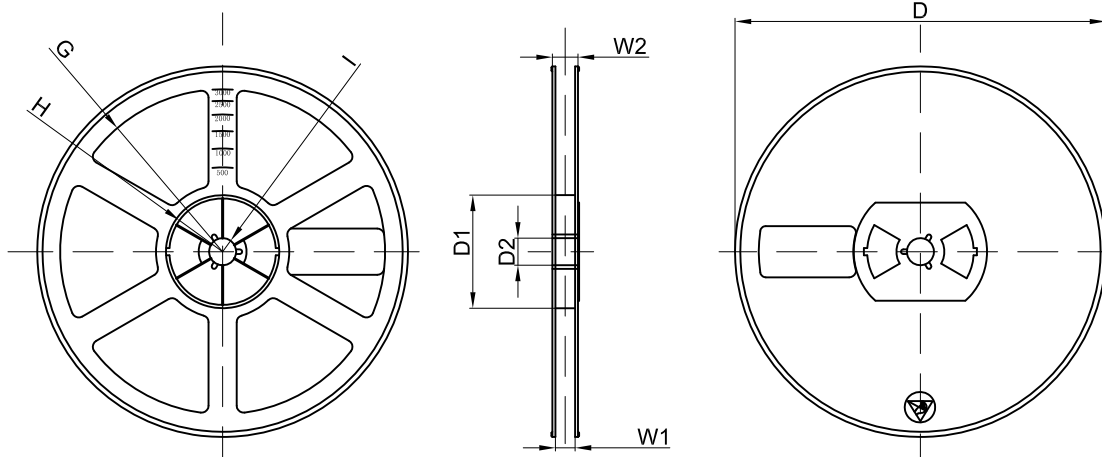

Dimensions are in millimeter								
Reel Option	D	D1	D2	G	H	I	W1	W2
7" Dia	Ø178.00	54.40	13.00	R78.00	R25.60	R6.50	9.50	12.30

REEL	Reel Size	Box	Box Size(mm)	Carton	Carton Size(mm)	G.W.(kg)
3000 pcs	7 inch	45,000 pcs	203×203×195	180,000 pcs	438×438×220	