

## Silicon NPN Power Transistors

2SC3858

## DESCRIPTION

- With MT-200 package
- Complement to type 2SA1494

## APPLICATIONS

- Audio and general purpose

## PINNING(see Fig.2)

PIN	DESCRIPTION
1	Base
2	Collector;connected to mounting base
3	Emitter

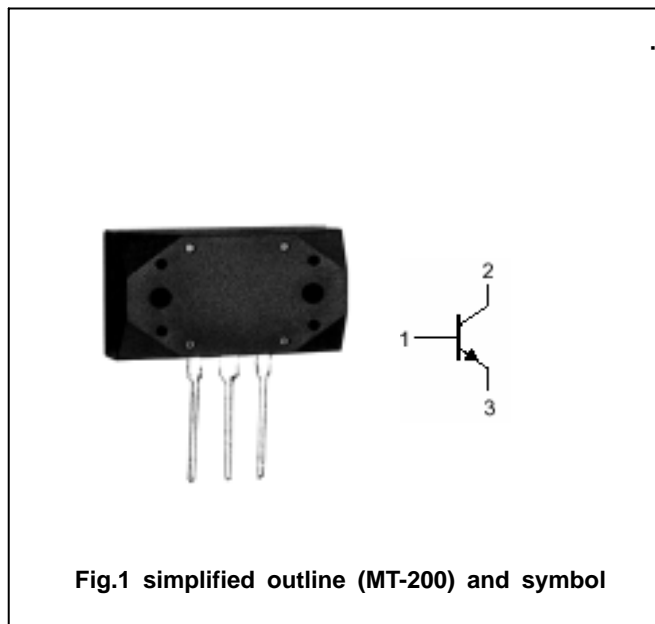

Fig.1 simplified outline (MT-200) and symbol

## Absolute maximum ratings (Ta=25°C)

SYMBOL	PARAMETER	CONDITIONS	VALUE	UNIT
$V_{CBO}$	Collector-base voltage	Open emitter	200	V
$V_{CEO}$	Collector-emitter voltage	Open base	200	V
$V_{EBO}$	Emitter-base voltage	Open collector	6	V
$I_C$	Collector current		17	A
$I_B$	Base current		5	A
$P_C$	Collector power dissipation	$T_C=25$	200	W
$T_j$	Junction temperature		150	
$T_{stg}$	Storage temperature		-55~150	

## Silicon NPN Power Transistors

## 2SC3858

## CHARACTERISTICS

T<sub>j</sub>=25 unless otherwise specified

SYMBOL	PARAMETER	CONDITIONS	MIN	TYP.	MAX	UNIT
V <sub>(BR)CEO</sub>	Collector-emitter breakdown voltage	I <sub>C</sub> =50mA; I <sub>B</sub> =0	200			V
V <sub>CEsat</sub>	Collector-emitter saturation voltage	I <sub>C</sub> =10 A; I <sub>B</sub> =1 A			2.5	V
I <sub>CBO</sub>	Collector cut-off current	V <sub>CB</sub> =200V; I <sub>E</sub> =0			100	μA
I <sub>EBO</sub>	Emitter cut-off current	V <sub>EB</sub> =6V; I <sub>C</sub> =0			100	μA
h <sub>FE</sub>	DC current gain	I <sub>C</sub> =8A; V <sub>CE</sub> =4V	50		180	
f <sub>T</sub>	Transition frequency	I <sub>C</sub> =1A; V <sub>CE</sub> =12V		20		MHz
C <sub>OB</sub>	Output capacitance	I <sub>E</sub> =0; V <sub>CB</sub> =10V; f=1MHz		300		pF

## Switching times

t <sub>on</sub>	Turn-on time	I <sub>C</sub> =10A; R <sub>L</sub> =4 I <sub>B1</sub> =- I <sub>B2</sub> =1A V <sub>CC</sub> =40V		0.50		μs
t <sub>s</sub>	Storage time			1.80		μs
t <sub>f</sub>	Fall time			0.60		μs

◆ h<sub>FE</sub> classifications

Y	P	G
50-100	70-140	90-180

PACKAGE OUTLINE

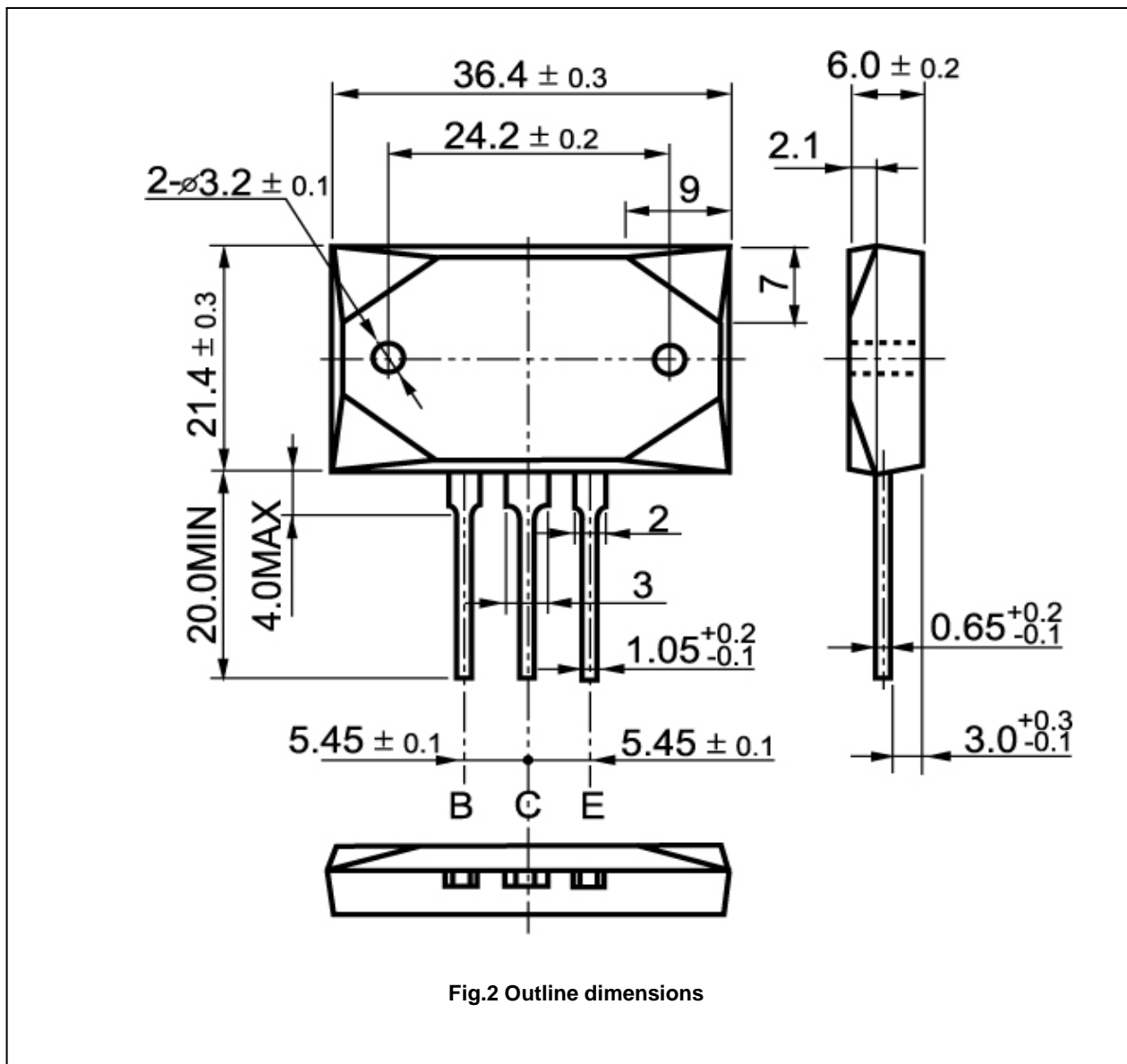

Fig.2 Outline dimensions

Silicon NPN Power Transistors

2SC3858

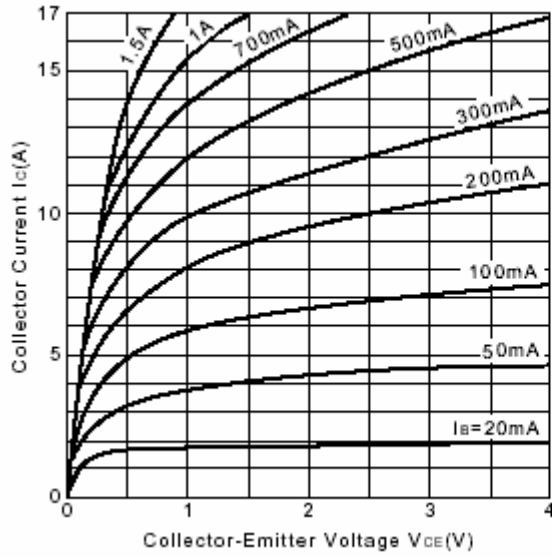

Fig.3 Static Characteristic

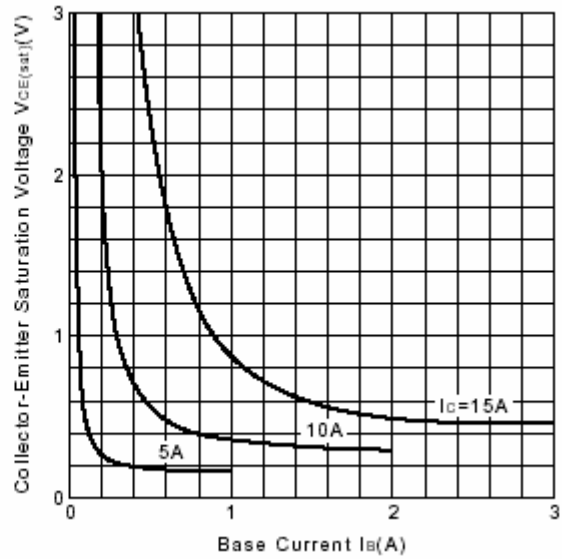

Fig.4 Vce(sat)-Ib Characteristics

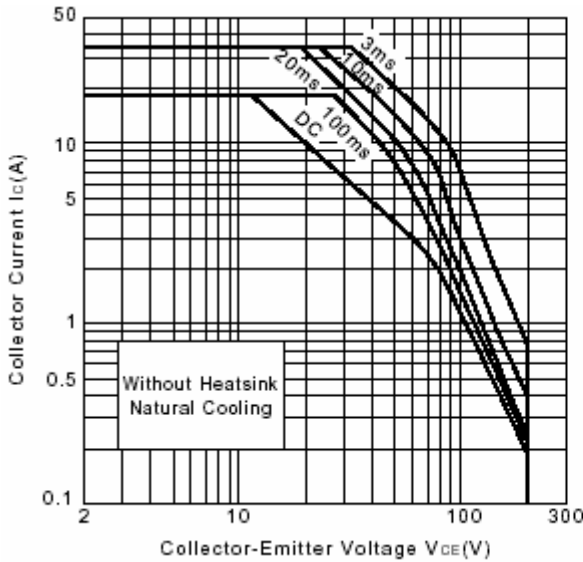

Fig.5 Safe Operating Area

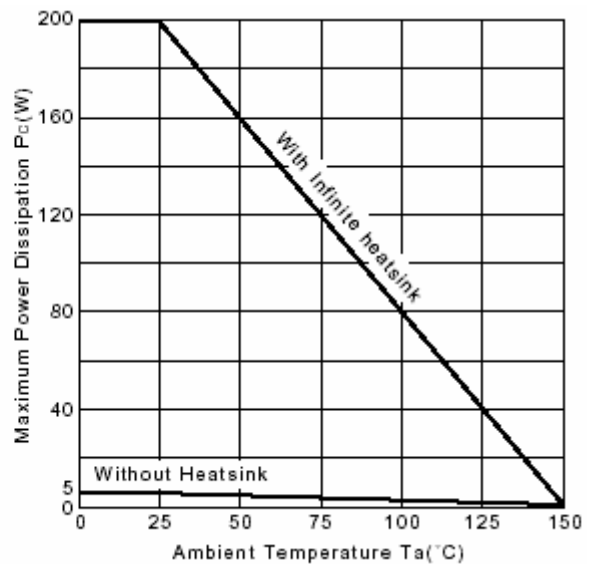

Fig.6 Pc-Ta Derating

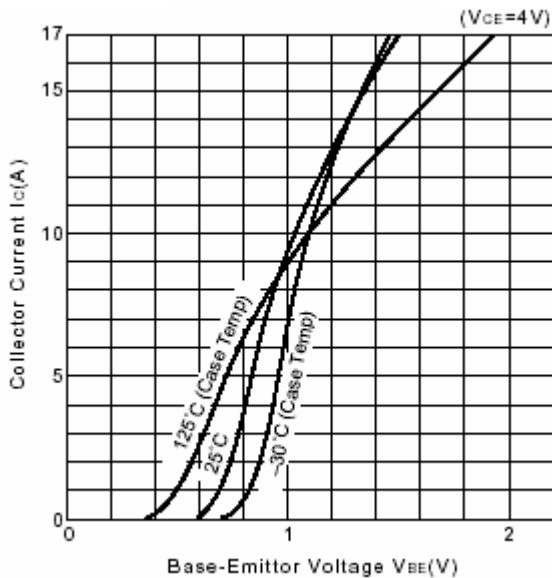

Fig.7 Ic-Vbe

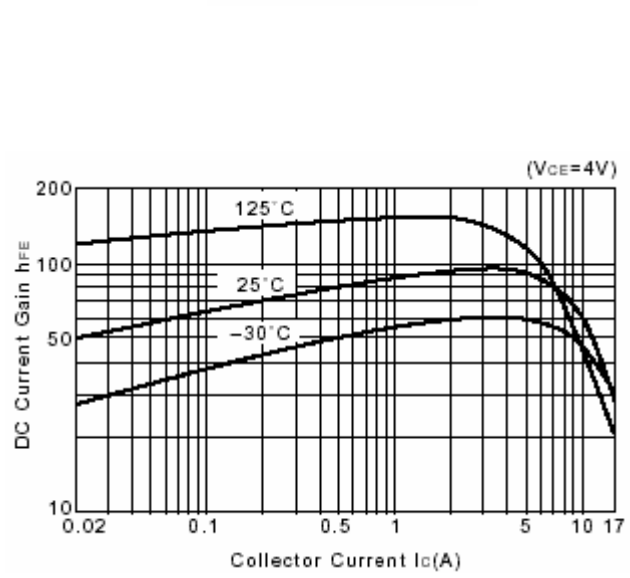

Fig.8 DC current Gain