

# 规格(承认)书

Specification for approval

※ 方舟 P/N (ARKLED P/N): SM2205613

※ 客户 P/N (CUSTOMER P/N): \_\_\_\_\_

※ 产品说明 (DESCRIPTION):

1、

2、

3、

※ 日期 (DATE): 2013 年 09 月 22 日

地址: 江苏省宜兴市张渚镇金张渚工业区宇龙路 6 号

ADD: NO.6 Yulong Road, ZHANGZHU TOWN, YIXING CITY, JIANGSU PROVINCE,  
P.R.CHINA

电话 (TEL): 0086-510-87341161 87345700

E-mail: [zhuzp@arkch.com](mailto:zhuzp@arkch.com)

传真(FAX): 0086-510-87342800

网址(http): [www.arkch.com](http://www.arkch.com)



型号 Type :

SM2205613



Page1 / 4

■ **产品特征 FEATURES:**

- 高可靠性和高稳定性

**High intensity and reliability**

- 高品质、和低功耗、低成本

**High quality, Low power requirement and low cost**

- IC 易兼容、易装配

**IC compatible , Easy assembly**

- 符合 RoHS 指令要求

**Meet RoHS EU Directive**

- 人体防静电承受能力 2000V (HMB)

**ESD 2000V (HMB)**

■ **产品描述 DESCRIPTION:**

- 0.56 英寸单位数码管

**0.56 Inch Single Digits Display**

- 极性共阴

**Common Cathode**

- 黑面, 白胶

**Black face, white segment**

- 发光颜色

**Luminous Color:**

1、黄绿色 Y/GREEN

2、

3、

4、

5、

- 晶片材质

**Chips Materials**

1、AlGaInP

2、

3、

4、

5、

型号 Type :

SM2205613



■ 产品最大绝对参数值 (Ta: 25°C) ABSOLUTE MAXIMUM RATINGS AT Ta=25°C:

PARAMETER 项目	SYMBOL 符号	Y/GREEN 黄绿色	UNIT 单位
Power Dissipation Per Segment 功耗	PAD	50	mw
Reverse Voltage Per Segment 反向耐压	VR	5	V
Continuous Forward Current Per Segment 最大使用电流	IAF	20	mA
Peak Forward Current Per Segment(Duty-0.1,1KHz) 最大峰值电流	IPF	60	mA
Operating Temperature Range 工作温度	TOPr	-20°C to 80°C	
Storage Temperature Range 贮藏温度	Tstg	-30°C to 85°C	
Lead Soldering Temperature 260°C at 1.6mm From Body for 3 second 焊接温度 260°C/3 秒 距离胶体 1.6mm 以上			

■ 产品光电参数值 (Ta: 25°C) ELECTRICAL/OPTICAL CHARACTERISTICS AT Ta=25°C:

PARAMETER 项目	SYMBOL 符号	TEST CONDITION 测试条件	Color 颜色	MIN 最小值	TYP 标准值	MAX 最大值	UNIT 单位
Forward Voltage ,Per Segment 正向压降	VF	IF=20mA	黄绿色 Y/GREEN	2.0	2.2	2.5	V
Reverse Current , Per Segment 反向漏电流	IR	VR=5V	黄绿色 Y/GREEN			50	μA
Peak Emission Wavelength 峰值波长	λp	IF=20mA	黄绿色 Y/GREEN	570	571	573	nm
Luminous Intensity Per Segment 法向光强	IV	IF=20mA	黄绿色 Y/GREEN	15	18	20	mcd

型号 Type :

SM2205613



RELATIVE INTENSITY VS. WAVELENGTH

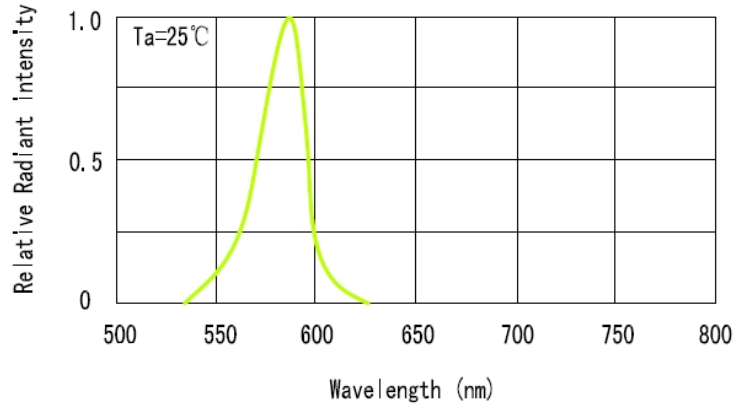

FORWARD CURRENT VS. FORWARD VOLTAGE

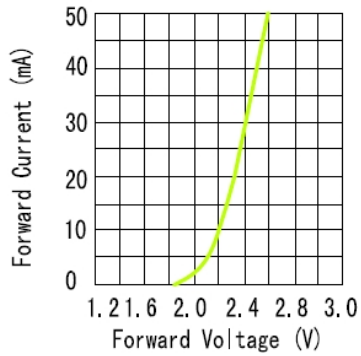

LUMINOUS INTENSITY VS. FORWARD CURRENT

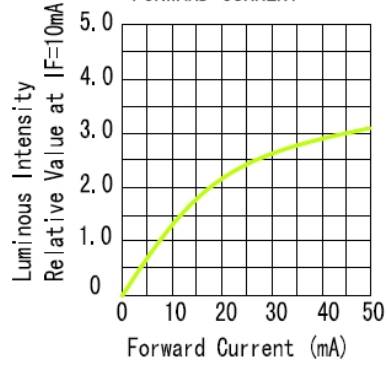

ALLOWABLE FORWARD CURRENT AMBIENT TEMPERATURE

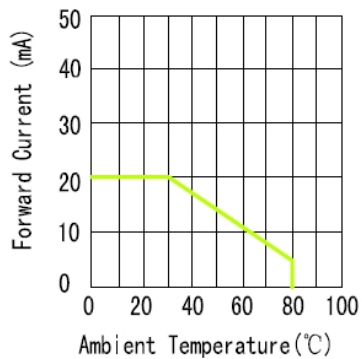

LUMINOUS INTENSITY VS. AMBIENT TEMPERATURE

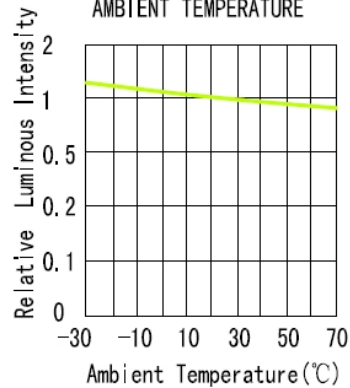

型号 Type :

SM2205613

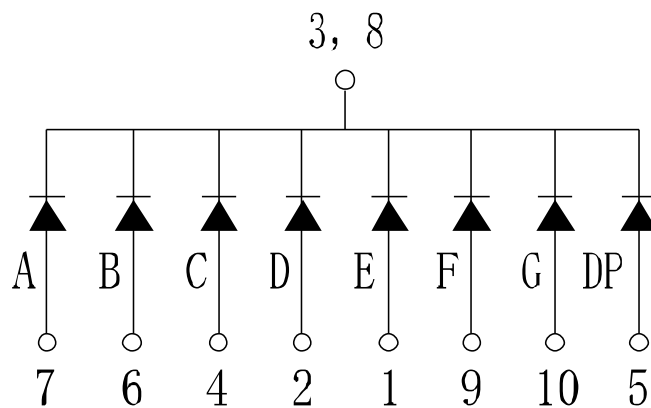
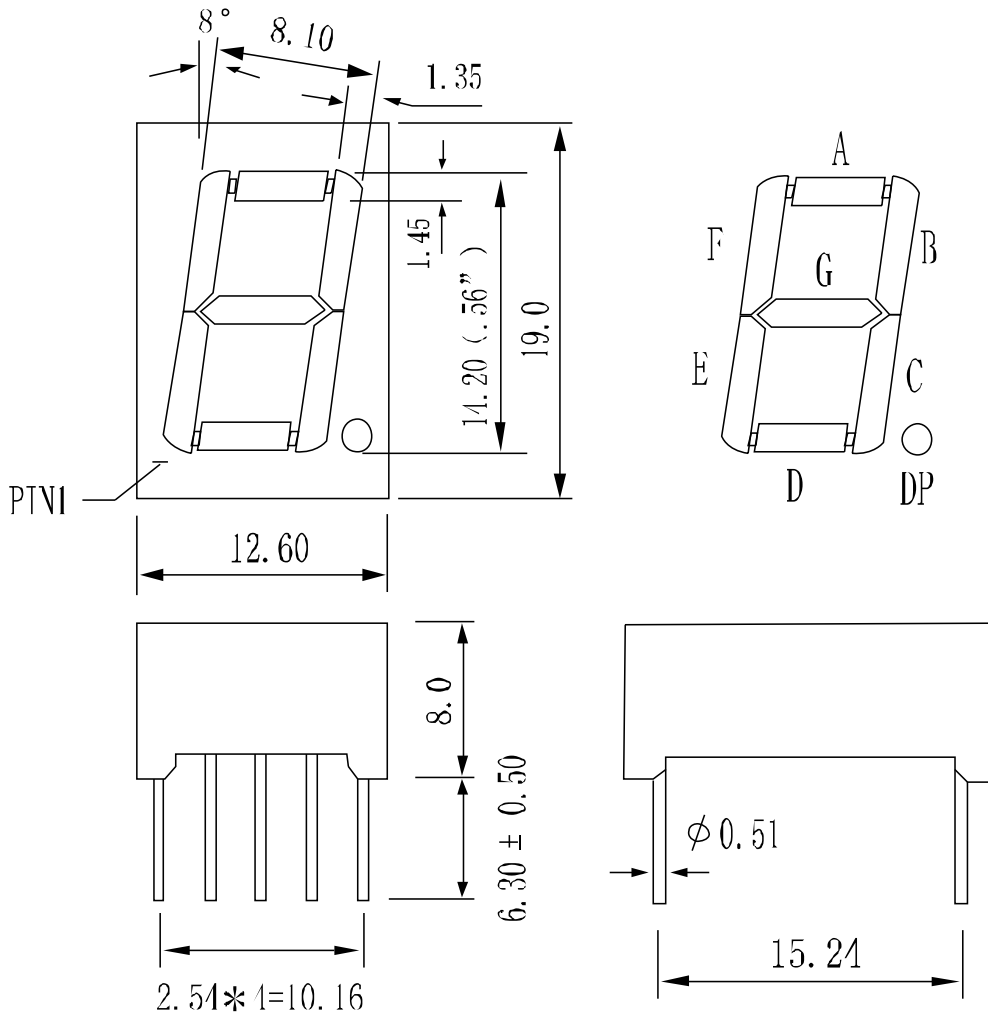

NOTES : 1. All dimensions are in millimeters. (inches)

2. Tolerance is  $\pm 0.25(0.010)$  unless otherwise specified.