

40V, Low Power, High Accuracy, High PSRR LDO Regulators

Description

The ME6233 series are high accuracy, CMOS LDO Voltage Regulators, offering low power, high ripple rejection ratio and low dropout. the ME6233 series is ideal for today's cutting edge mobile phone. Internally the ME6233 includes a reference voltage source, error amplifiers, driver transistors, current limiters and phase compensators. The ME6233's current limiters' foldback circuit also operates as a short protect for the output current limiter and the output pin. The ME6233 series is also fully compatible with low ESR ceramic capacitors, reducing cost and improving output stability. This high level of output stability is maintained even during frequent load fluctuations, due to the excellent transient response performance and high PSRR achieved across a broad range of frequencies. The CE function allows the output of regulator to be turned off, resulting in greatly reduced power consumption.

Applications

- Mobile phones
- Cordless phones, radio communication equipment
- Portable games
- Cameras, Video cameras
- Reference voltage sources
- Battery powered equipment

Feature

- Maximum Output Current: 100mA
($V_{IN}=4.5V, V_{OUT}=3.3V$)
- Dropout Voltage: 116mV@ $I_{OUT}=10mA$ ($V_{OUT}=3.3V$)
- Operating Voltage Range: 4.5V~40V
- Output Voltage Range: 1.6V~12.0V
- Highly Accuracy: $\pm 1\%$
- Low Power Consumption: 3.5uA (TYP.)
- Standby Current: 0.4 uA (TYP.)
- High Ripple Rejection: 61dB@1KHz (ME6233C33)
- Line Regulation: 0.035%/V (TYP.)
- Built-in temperature protection and current limiting protection

Package

- 3-pin SOT23-3、SOT89-3
- 5-pin SOT23-5

Typical Application Circuit

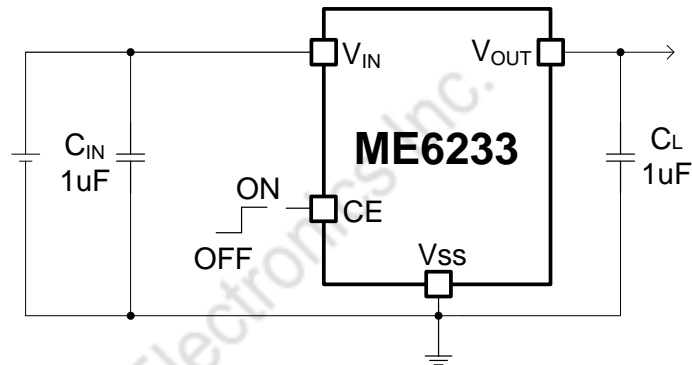

Note: Ceramic capacitor with X7R and X5R offer improved voltage and temperature coefficients. 10uF Ceramic capacitor is recommended for excellent load transient response and line transient response.

Selection Guide

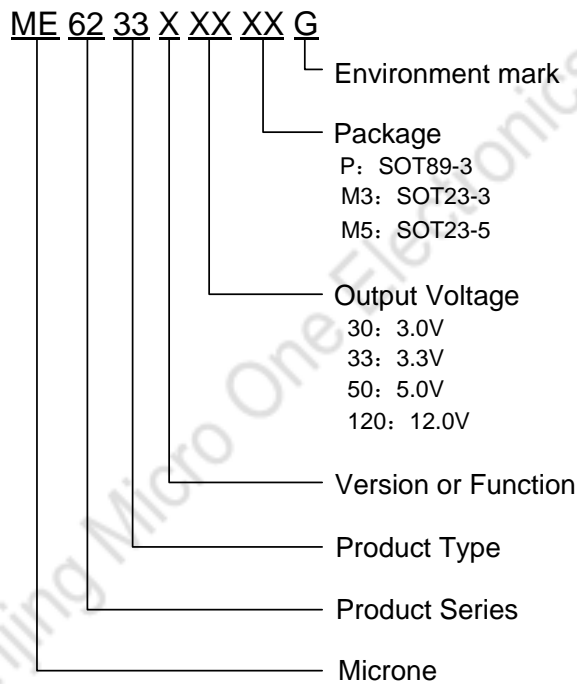

product serie	Product Function
ME6233A30M3G	$V_{OUT}=3.0V$; Package: SOT23-3
ME6233A33PG	$V_{OUT}=3.3V$; Package: SOT89-3
ME6233A50M3G	$V_{OUT}=5.0V$; Package: SOT23-3
ME6233A50PG	$V_{OUT}=5.0V$; Package: SOT89-3
ME6233A120PG	$V_{OUT}=12.0V$; Package: SOT89-3
ME6233C30M5G	Enable can be set; $V_{OUT}=3.0V$; Package: SOT23-5
ME6233C33M5G	Enable can be set; $V_{OUT}=3.3V$; Package: SOT23-5
ME6233C50M5G	Enable can be set; $V_{OUT}=5.0V$; Package: SOT23-5
ME6233C120M5G	Enable can be set; $V_{OUT}=12.0V$; Package: SOT23-5

NOTE: If you need other voltage and package, please contact our sales staff.

Pin Configuration (Top View)

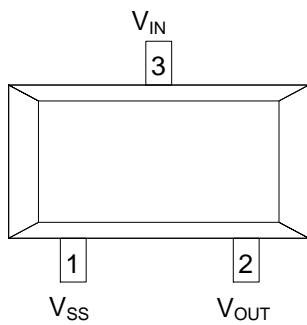

SOT23-3

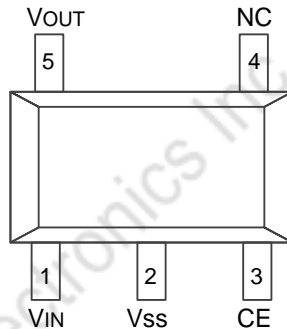

SOT23-5

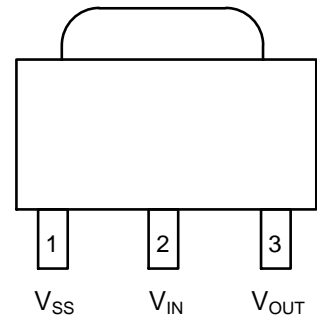

SOT89-3

Pin Assignment

PIN Number (SOT23-3)	PIN Number (SOT23-5)	PIN Number (SOT89-3)	symbol	Function
3	1	2	V _{IN}	Power Input
1	2	1	V _{SS}	Ground
-	3	-	CE	ON/OFF Control
-	4	-	NC	No Connect
2	5	3	V _{OUT}	Output

Block Diagram

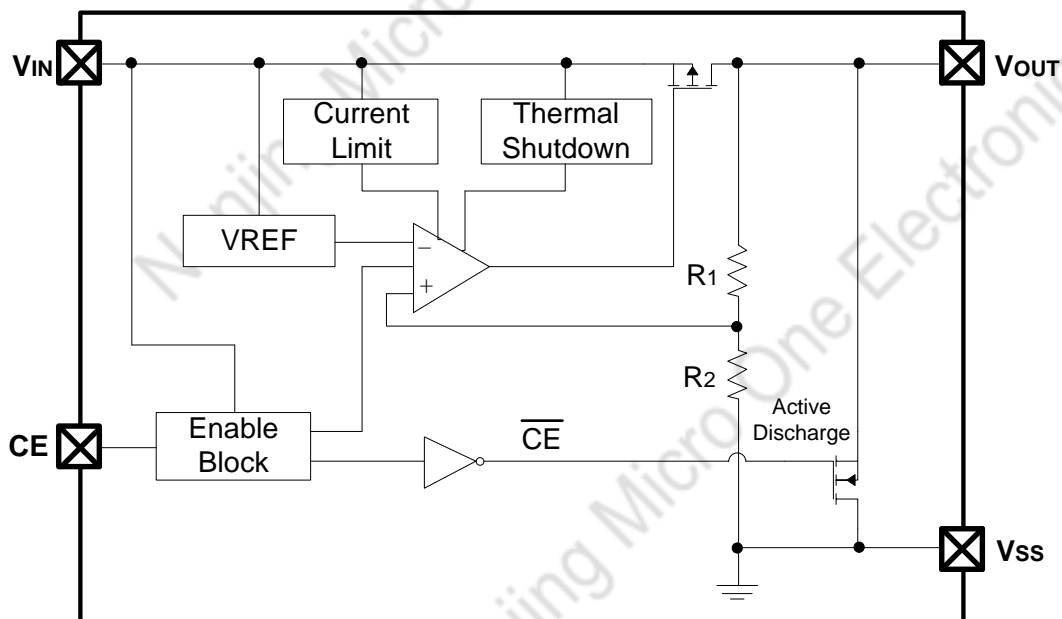

Absolute Maximum Ratings

Parameter	Symbol	Ratings	Units
Input Voltage	V_{IN}	-0.3 ~ 40	V
CE Pin Voltage	V_{CE}	$V_{IN} - 0.3 \sim V_{IN} + 0.3$	V
V_{OUT} Voltage	V_{OUT}	$V_{IN} - 0.3 \sim V_{IN} + 0.3$	V
V_{OUT} Current	I_{OUT}	300	mA
Internal Power Dissipation ($T_A = 25^\circ\text{C}$)	SOT23-3	0.54	W
	SOT23-5	0.6	
	SOT89-3	1.25	
Thermal resistance (Junction to air)	SOT23-3	230	$^\circ\text{C/W}$
	SOT23-5	210	
	SOT89-3	100	
Operating Ambient Temperature Range	T_{Opr}	-40~+85	$^\circ\text{C}$
Storage Temperature Range	T_{stg}	-55~+150	$^\circ\text{C}$
Maximum junction temperature	T_J	-40~+150	$^\circ\text{C}$

Electrical Characteristic

($V_{IN} = V_{OUT} + 1.5\text{V}$, $V_{CE} = V_{IN}$, $C_{IN} = C_L = 1\mu\text{F}$, $T_a = 25^\circ\text{C}$, unless otherwise noted)

Parameter	Symbol	Conditions	Min.	Typ.	Max.	Units
Operating Input Voltage	V_{IN}		4.5	-	40	V
Output Voltage	$V_{OUT(E)}$ (Note 2)	$I_{OUT} = 10\text{mA}$, $V_{IN} = V_{OUT} + 2\text{V}$	X 0.99	$V_{OUT(T)}$ (Note 1)	X 1.01	V
Maximum Output Current	I_{OUTMAX}	$V_{IN} = V_{OUT} + 2\text{V}$	-	100	-	mA
Load Regulation	ΔV_{OUT}	$V_{IN} = V_{OUT} + 2\text{V}$, $1\text{mA} \leq I_{OUT} \leq 100\text{mA}$	-	11	-	mV
Dropout Voltage (Note 3)	V_{DIF}	$I_{OUT} = 10\text{mA}$	-	0.116	-	V
		$I_{OUT} = 50\text{mA}$	-	0.577	-	
		$I_{OUT} = 100\text{mA}$	-	1.198	-	
Supply Current	I_{SS}	$V_{IN} = V_{OUT} + 2\text{V}$ $V_{OUT} < 8\text{V}$	-	3.5	6	μA
		$V_{IN} = V_{OUT} + 2\text{V}$ $8 \leq V_{OUT} \leq 12\text{V}$	-	5	7	
Stand-by Current	I_{CEL}	$V_{CE} = 0\text{V}$	-	0.4	1	μA
Line Regulation	$\frac{\Delta V_{OUT}}{\Delta V_{IN} \cdot V_{OUT}}$	$I_{OUT} = 10\text{mA}$, $V_{OUT} + 2\text{V} \leq V_{IN} \leq 40\text{V}$	-	0.01	-	%/V
Output Current Limit	I_{LIM}	Peak Output Current	-	211	-	mA
CE "High" Voltage	V_{CEH}	Start up	0.9	-	-	V
CE "Low" Voltage	V_{CEL}	Shut down	-	-	0.7	V
Active Output Discharge Resistance	R_{DIS}	$V_{CE} < 0.5\text{V}$	-	1600	-	Ω
Ripple Rejection	PSRR	$V_{IN} = 5\text{V} + 1\text{V}_{rmsAC}$, $f = 100\text{Hz}$	-	63	-	dB

Rate(Note 4)		$I_{OUT}=10mA$	$f=1kHz$	-	61	-	
			$f=10kHz$	-	45	-	
Thermal Shutdown Temperature(Note 4)	T_{SD}	Temperature increasing, $I_{OUT}=10mA$		-	151	-	$^{\circ}C$
Thermal Shutdown Hysteresis(Note 4)	ΔT_{SD}	Temperature falling		-	25	-	$^{\circ}C$

NOTES:

- $V_{OUT}(T)$: Specified Output Voltage
- $V_{OUT}(E)$: Effective Output Voltage (i.e. The output voltage when “ $V_{OUT}(T)+1.0V$ ”is provided at the V_{in} pin while maintaining a certain I_{out} value.)
- V_{DIF} : $V_{IN1} - V_{OUT}(E)'$
 V_{IN1} : The input voltage when $V_{OUT}(E)'$ appears as input voltage is gradually decreased.
 $V_{OUT}(E)'$ =A voltage equal to 98% of the output voltage whenever an amply stabilized I_{out} { $V_{OUT}(T)+1.0V$ } is input.
- guaranteed by design.

Typical Performance Characteristics

ME6233C33M5G ($V_{CE} = V_{IN}, T_a=25^{\circ}C, C_{IN}=C_L=1\mu F$, unless otherwise noted.)

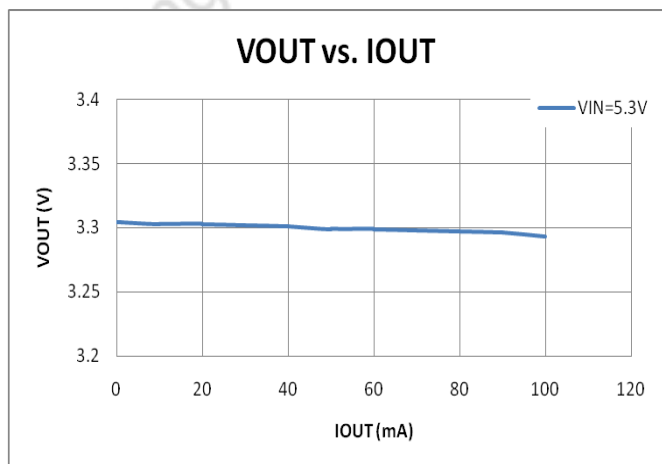

Figure 1. Output Voltage vs. Output Current

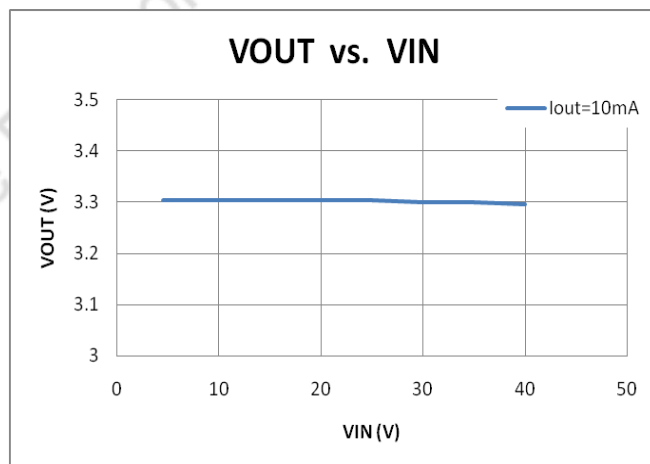

Figure 2. Output Voltage vs. Input Voltage

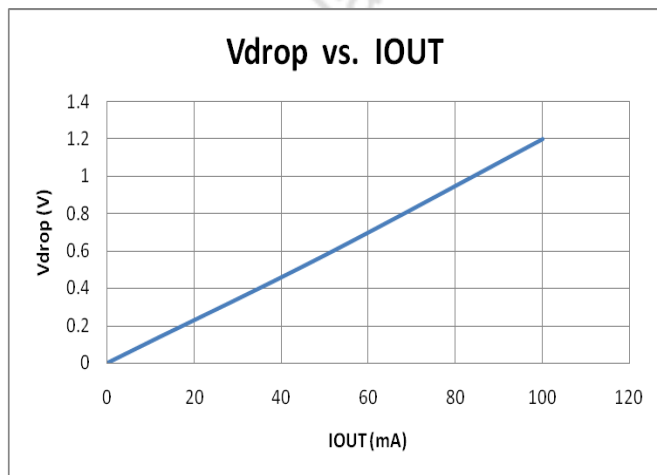

Figure 3. Dropout Voltage vs. Output Current

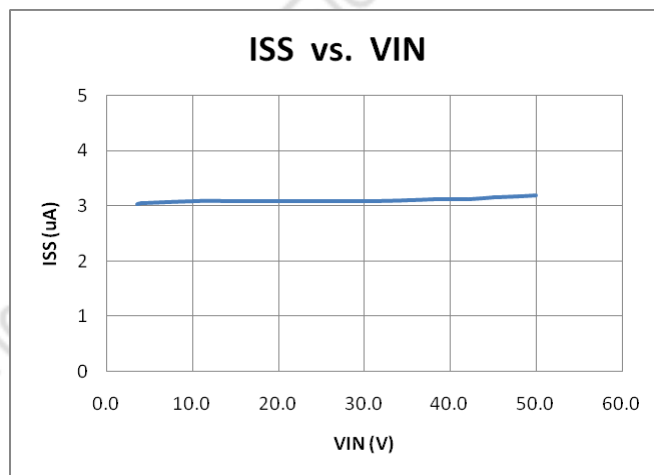

Figure 4. Quiescent Current vs. Input Voltage

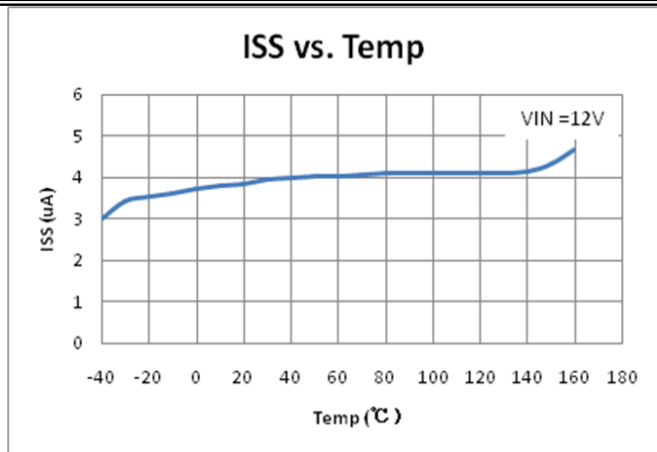

Figure 5. Quiescent Current vs. Temperature

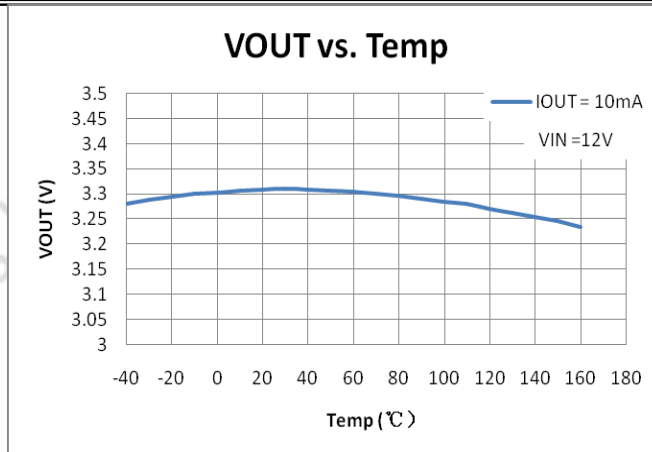

Figure 6. Output Voltage vs. Temperature

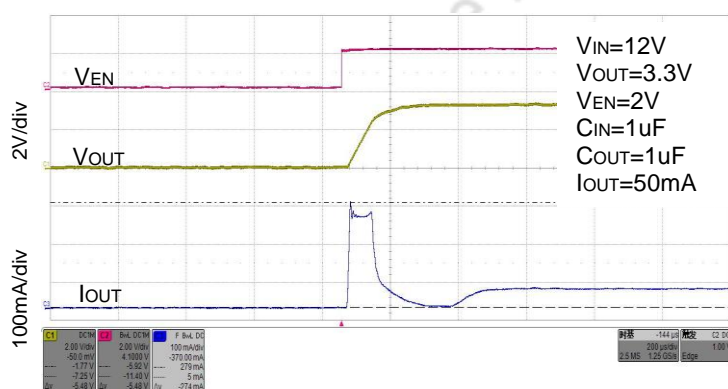

Figure 7. Enable Turn-on Response

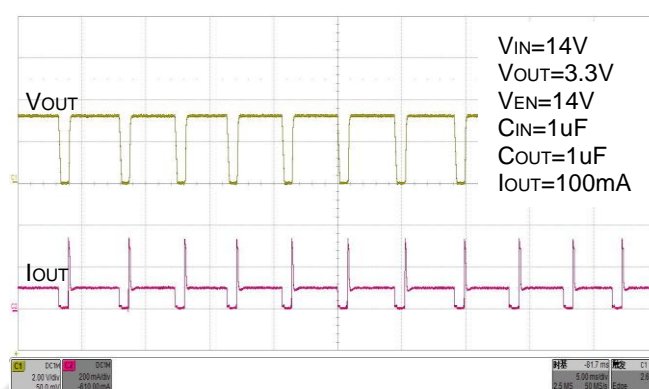

Figure 8. Thermal Shutdown

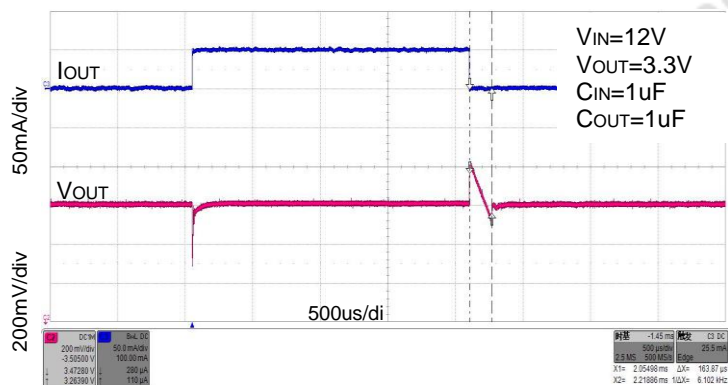

Figure 9. Load Transient Response
IOUT=1mA to 50mA

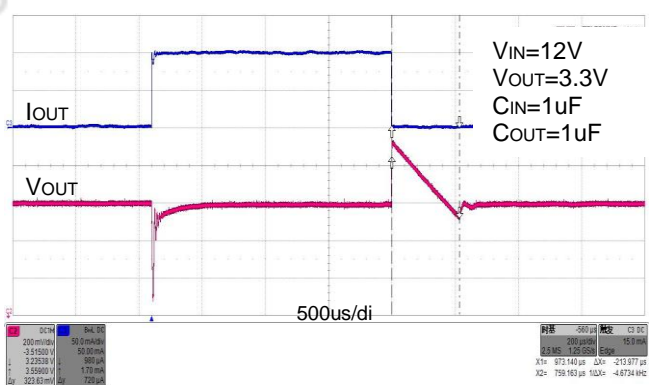

Figure 10. Load Transient Response
IOUT=10mA to 100mA

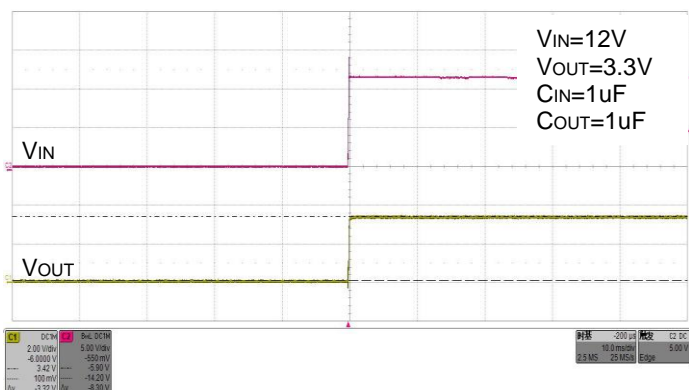

Figure 11. Single Hot plug and hot Un-plug

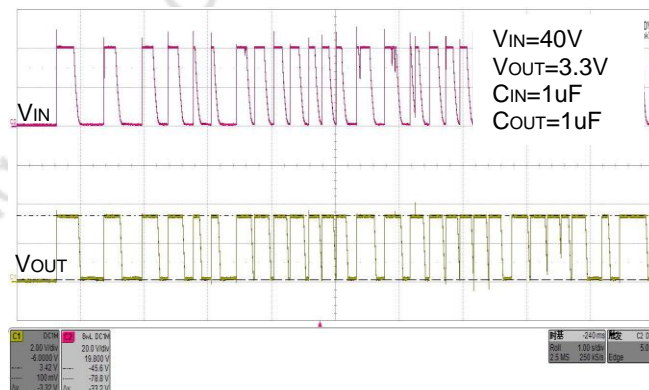
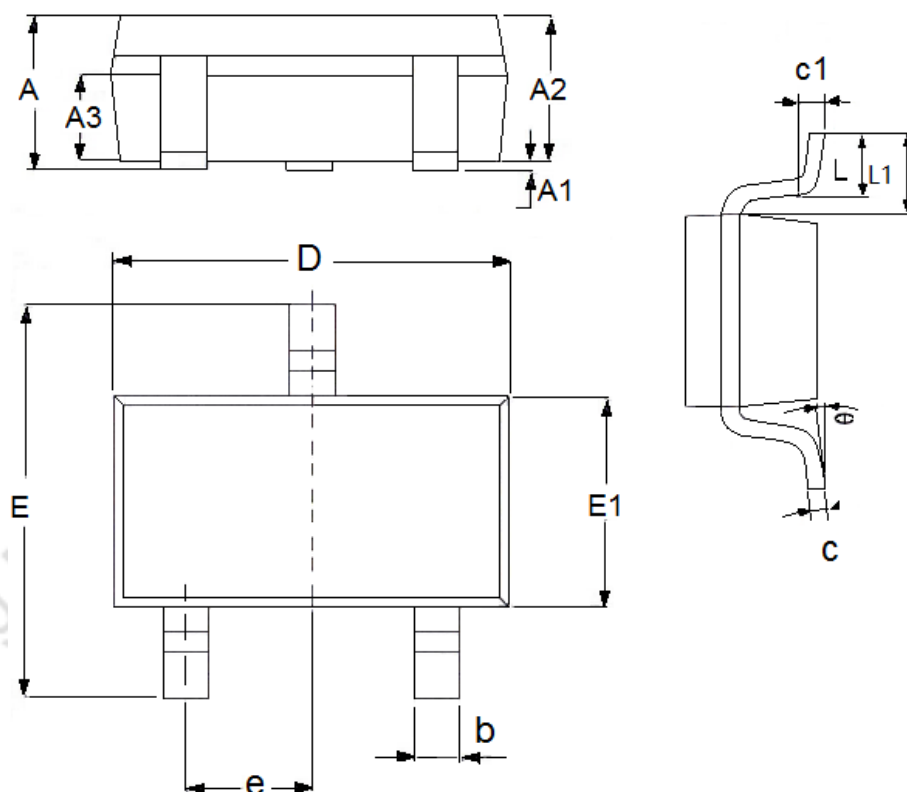

Figure 12. Continuous Hot plug and hot Un-plug

Packaging Information

- Package Type:SOT23-3



DIM	Millimeters		Inches	
	Min	Max	Min	Max
A	1.05	1.45	0.0413	0.0571
A1	0	0.15	0.0000	0.0059
A2	0.9	1.3	0.0354	0.0512
A3	0.6	0.7	0.0236	0.0276
b	0.25	0.5	0.0098	0.0197
c	0.1	0.25	0.0039	0.0098
D	2.8	3.1	0.1102	0.1220
E	2.6	3.1	0.1023	0.1220
E1	1.5	1.8	0.0591	0.0709
e	0.95(TYP)		0.0374(TYP)	
L	0.25	0.6	0.0098	0.0236
L1	0.59(TYP)		0.0232(TYP)	
θ	0	8°	0.0000	8°
c1	0.2(TYP)		0.0079(TYP)	

● Package Type:SOT23-5

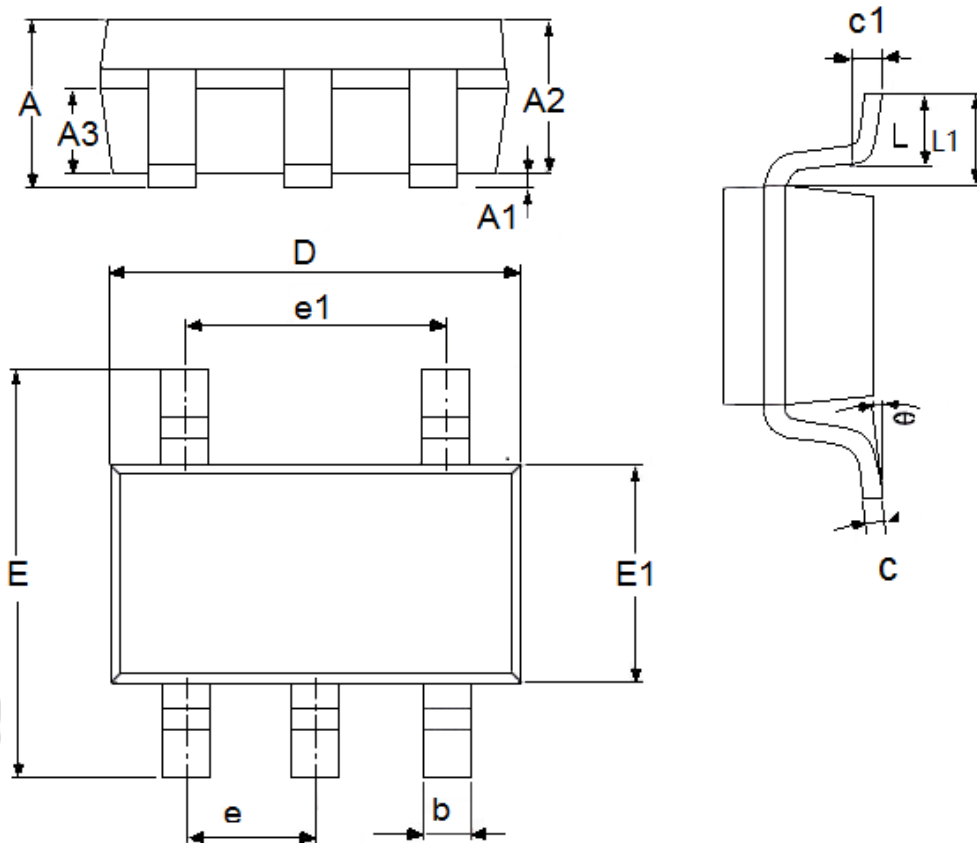

DIM	Millimeters		Inches	
	Min	Max	Min	Max
A	1.05	1.45	0.0413	0.0571
A1	0	0.15	0.0000	0.0059
A2	0.9	1.3	0.0354	0.0512
A3	0.6	0.7	0.0236	0.0276
b	0.25	0.5	0.0098	0.0197
c	0.1	0.23	0.0039	0.0091
D	2.82	3.05	0.1110	0.1201
e1	1.9(TYP)		0.0748(TYP)	
E	2.6	3.05	0.1024	0.1201
E1	1.5	1.75	0.0512	0.0689
e	0.95(TYP)		0.0374(TYP)	
L	0.3	0.6	0.0118	0.0236
L1	0.59(TYP)		0.0232(TYP)	
θ	0	8°	0.0000	8°
c1	0.2(TYP)		0.0079(TYP)	

● Package Type: SOT89-3

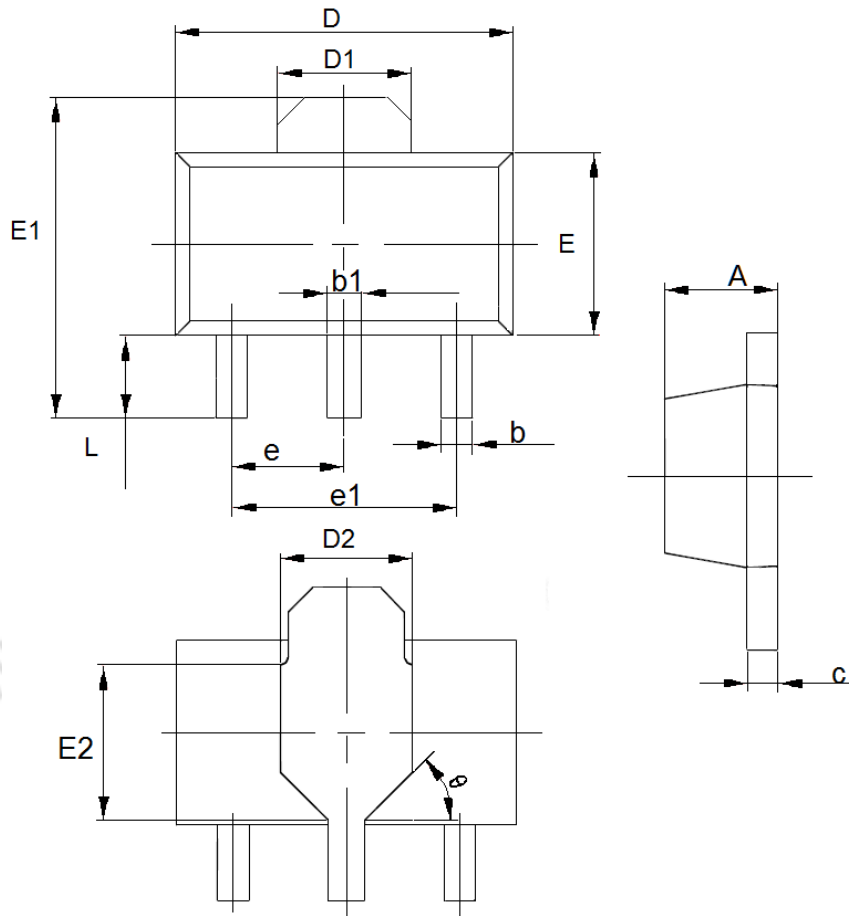

DIM	Millimeters		Inches	
	Min	Max	Min	Max
A	1.4	1.6	0.0551	0.0630
b	0.32	0.52	0.0126	0.0205
b1	0.4	0.58	0.0157	0.0228
c	0.35	0.45	0.0138	0.0177
D	4.4	4.6	0.1732	0.1811
D1	1.55(TYP)		0.061(TYP)	
D2	1.75(TYP)		0.0689(TYP)	
e1	3.0(TYP)		0.1181(TYP)	
E	2.3	2.6	0.0906	0.1023
E1	3.94	4.4	0.1551	0.1732
E2	1.9(TYP)		0.0748(TYP)	
e	1.5(TYP)		0.0591(TYP)	
L	0.8	1.2	0.0315	0.0472
θ	45°		45°	

- The contents of this document will be updated with the product's improvement without prior notice. Please consult our sales staff before using this document to ensure that you are using the latest version.
- The application circuit examples described in this document are only used to indicate the representative use of the product and do not guarantee the design of mass production.
- Please use this product within the limits stated in this document. We will not be responsible for any damage caused by improper use.
- The products described in this document are not allowed to be used in equipment or devices that affect the human body without the written permission of our company, including but not limited to: health equipment, medical equipment, disaster prevention equipment, fuel control equipment, automobile equipment, aviation equipment and vehicle equipment.
- Although our company has always been committed to improving product quality and reliability, semiconductor products have a certain probability of malfunction or wrong work. To prevent personal injury or property damage caused by such accidents, please pay full attention to safety design, for example: Alternate design, fire protection design, and prevention of wrong action design.
- When exporting this product or this document overseas, you should abide by applicable import and export control laws.
- Copying or reprinting part or all of this document in any form without the permission of our company is strictly prohibited.