

N-Ch 100V Fast Switching MOSFETs
Description

The HSBA0048 is the high cell density trench N-ch MOSFETs, which provide excellent R_{DS(ON)} and gate charge for most of the Synchronous Rectification for AC/DC Quick Charger.

- 100% EAS Guaranteed
- LOW R_{DS(ON)}
- Low Gate Charge
- RoHs and Halogen-Free Compliant

Product Summary

V _{DS}	100	V
R _{DS(ON),TYP}	6.6	mΩ
I _D	78	A

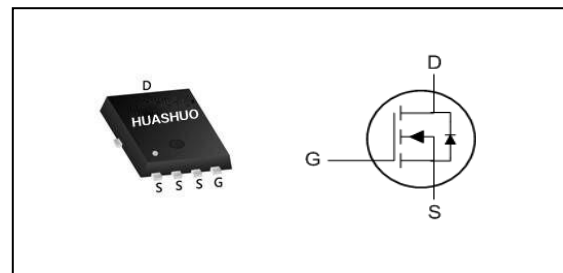
PRPAK5X6 Pin Configuration

Absolute Maximum Ratings

Symbol	Parameter	Rating	Units
V _{DS}	Drain-Source Voltage	100	V
V _{GS}	Gate-Source Voltage	±20	V
I _D @T _C =25°C	Continuous Drain Current ^{1,6}	78	A
I _D @T _C =70°C	Continuous Drain Current ^{1,6}	62	A
I _{DM}	Pulsed Drain Current ²	280	A
EAS	Single Pulse Avalanche Energy ³	61	mJ
I _{AS}	Avalanche Current	23	A
P _D @T _C =25°C	Total Power Dissipation ⁴	108	W
T _{STG}	Storage Temperature Range	-55 to 150	°C
T _J	Operating Junction Temperature Range	-55 to 150	°C

Thermal Data

Symbol	Parameter	Typ.	Max.	Unit
R _{θJA}	Thermal Resistance Junction-Ambient ¹ (t ≤ 10s)	---	25	°C/W
	Thermal Resistance Junction-Ambient ¹	---	55	°C/W
R _{θJC}	Thermal Resistance Junction-Case ¹	---	1.15	°C/W

N-Ch 100V Fast Switching MOSFETs
Electrical Characteristics (T_J=25 °C, unless otherwise noted)

Symbol	Parameter	Conditions	Min.	Typ.	Max.	Unit
BV _{DSS}	Drain-Source Breakdown Voltage	V _{GS} =0V, I _D =250uA	100	---	---	V
R _{DS(ON)}	Static Drain-Source On-Resistance ²	V _{GS} =10V, I _D =13.5A	---	6.6	8	mΩ
	Static Drain-Source On-Resistance ²	V _{GS} =4.5V, I _D =11.5A	---	8.7	10.5	
V _{GS(th)}	Gate Threshold Voltage	V _{GS} =V _{DS} , I _D =250uA	1.2	---	2.3	V
I _{DSS}	Drain-Source Leakage Current	V _{DS} =80V, V _{GS} =0V, T _J =25°C	---	---	1	uA
		V _{DS} =80V, V _{GS} =0V, T _J =55°C	---	---	5	
I _{GSS}	Gate-Source Leakage Current	V _{GS} =±20V, V _{DS} =0V	---	---	±100	nA
g _{fs}	Forward Transconductance	V _{DS} =5V, I _D =20A	---	85	---	S
Q _g	Total Gate Charge (10V)	V _{DS} =50V, V _{GS} =10V, I _D =13.5A	---	45	---	nC
Q _g	Total Gate Charge (4.5V)		---	19.3	---	
Q _{gs}	Gate-Source Charge		---	9.5	---	
Q _{gd}	Gate-Drain Charge		---	4.8	---	
T _{d(on)}	Turn-On Delay Time	V _{DD} =50V, V _{GS} =10V, R _G =3Ω, I _D =13.5A	---	10	---	ns
T _r	Rise Time		---	6.5	---	
T _{d(off)}	Turn-Off Delay Time		---	45	---	
T _f	Fall Time		---	7.5	---	
C _{iss}	Input Capacitance	V _{DS} =50V, V _{GS} =0V, f=1MHz	---	3320	---	pF
C _{oss}	Output Capacitance		---	605	---	
C _{rss}	Reverse Transfer Capacitance		---	20	---	

Diode Characteristics

Symbol	Parameter	Conditions	Min.	Typ.	Max.	Unit
I _S	Continuous Source Current ^{1,5,6}	V _G =V _D =0V, Force Current	---	---	48	A
V _{SD}	Diode Forward Voltage ²	V _{GS} =0V, I _S =1A, T _J =25°C	---	---	1.1	V
t _{rr}	Reverse Recovery Time	I _F =13.5A, di/dt=100A/μs,	---	33	---	nS
Q _{rr}	Reverse Recovery Charge	T _J =25°C	---	150	---	nC

Note :

- 1.The data tested by surface mounted on a 1 inch²FR-4 board with 2OZ copper.
- 2.The data tested by pulsed, pulse width ≤ 300us, duty cycle ≤ 2%
- 3.The EAS data shows Max. rating. The test condition is V_{DD}=25V, V_{GS}=10V, L=0.3mH, I_{AS}=23A
- 4.The power dissipation is limited by 150°C junction temperature
- 5.The data is theoretically the same as I_D and I_{DM}, in real applications, should be limited by total power dissipation.
- 6.The maximum current rating is package limited.

Typical Characteristics

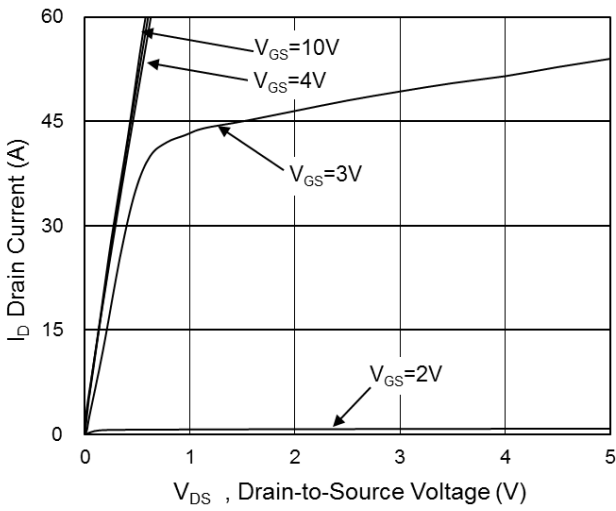

Fig.1 Typical Output Characteristics

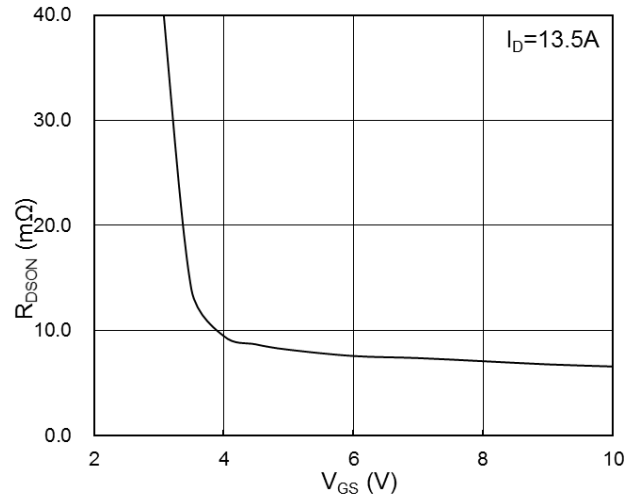

Fig.2 On-Resistance vs G-S Voltage

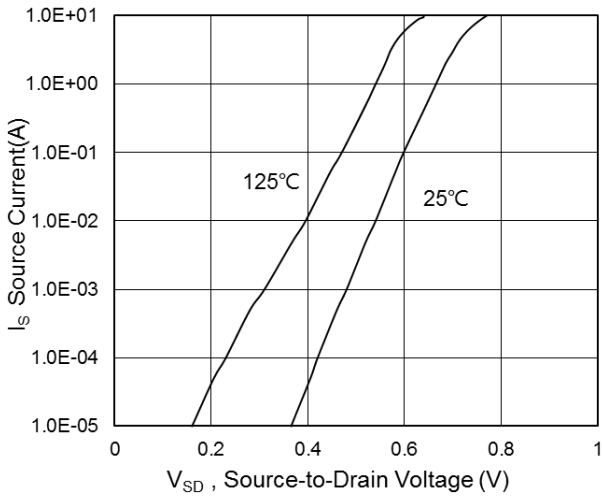

Fig.3 Source-Drain Forward Characteristics

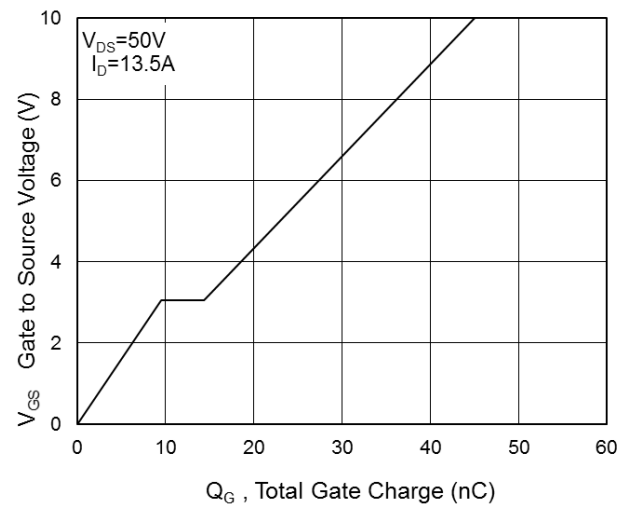

Fig.4 Gate-Charge Characteristics

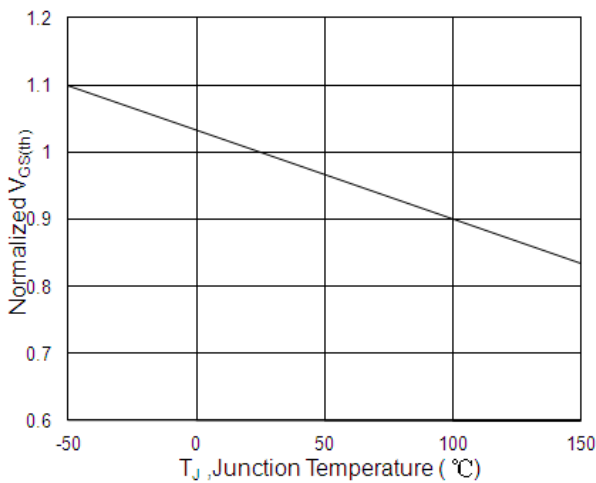

Fig.5 Normalized $V_{GS(th)}$ vs T_J

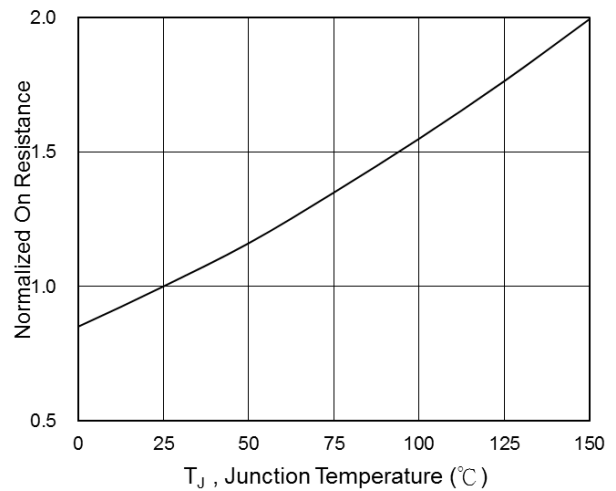

Fig.6 Normalized $R_{DS(on)}$ vs T_J

N-Ch 100V Fast Switching MOSFETs

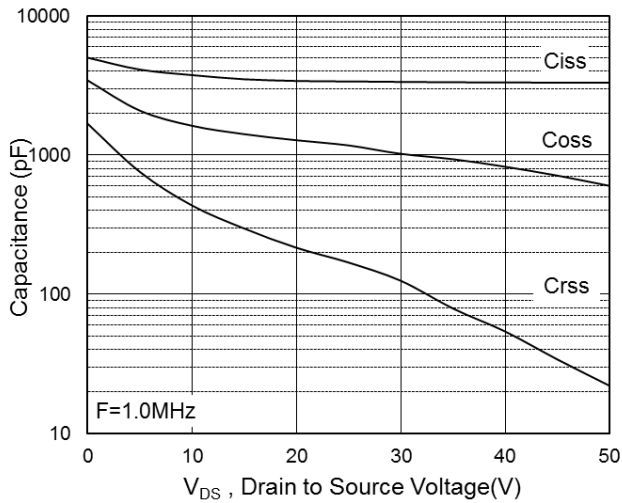

Fig.7 Capacitance

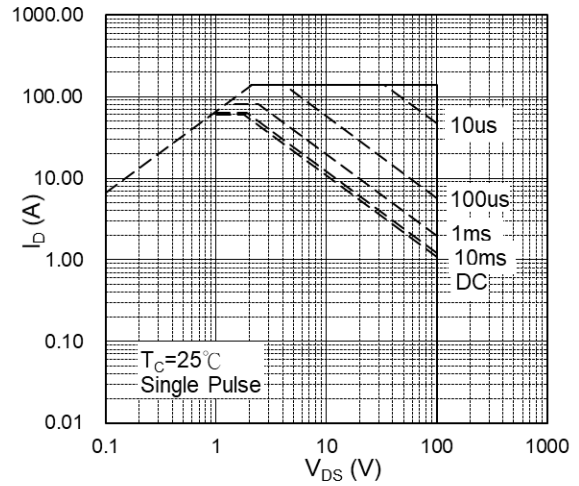

Fig.8 Safe Operating Area

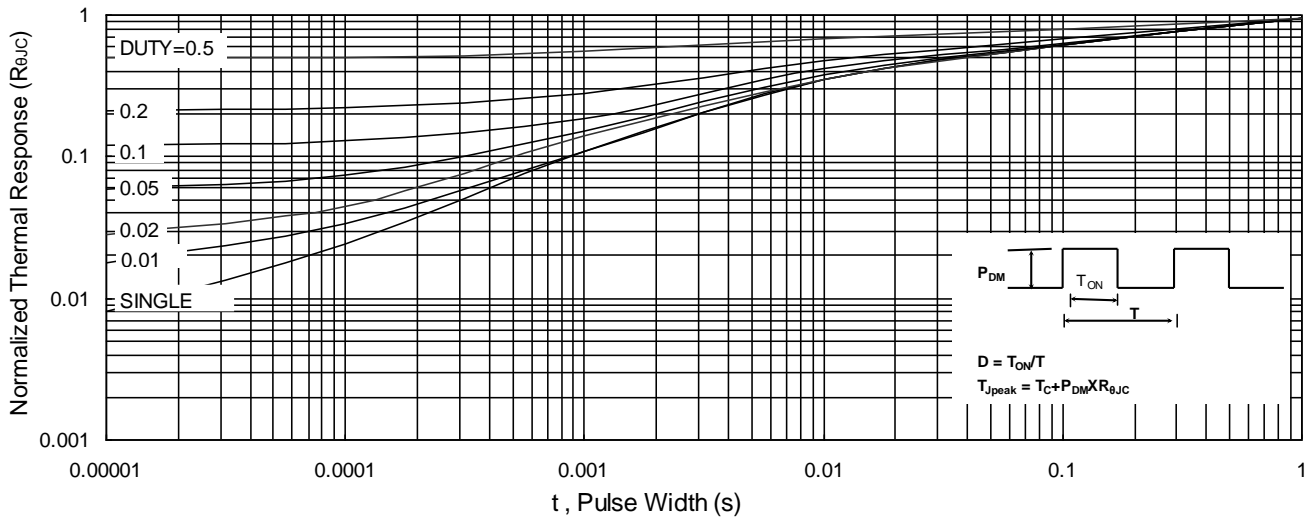

Fig.9 Normalized Maximum Transient Thermal Impedance

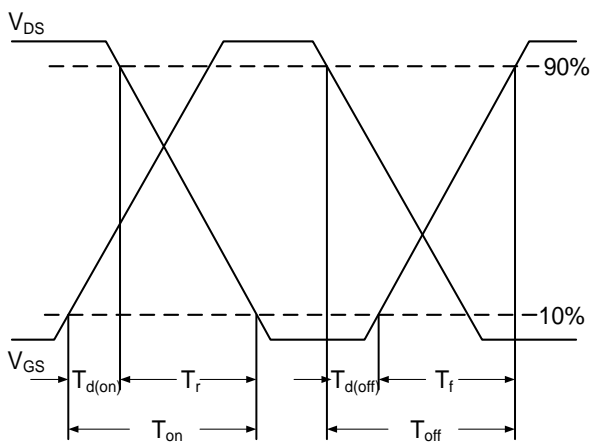

Fig.10 Switching Time Waveform

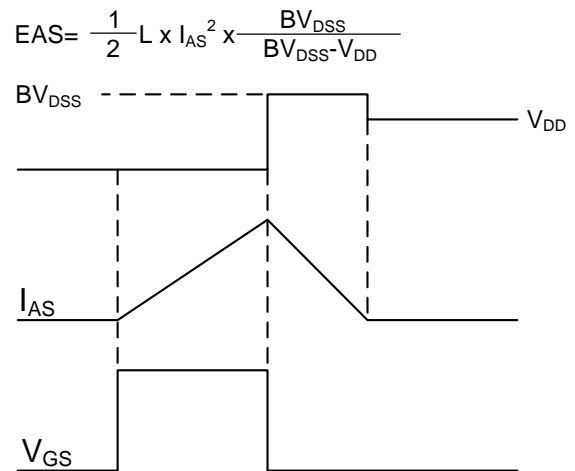
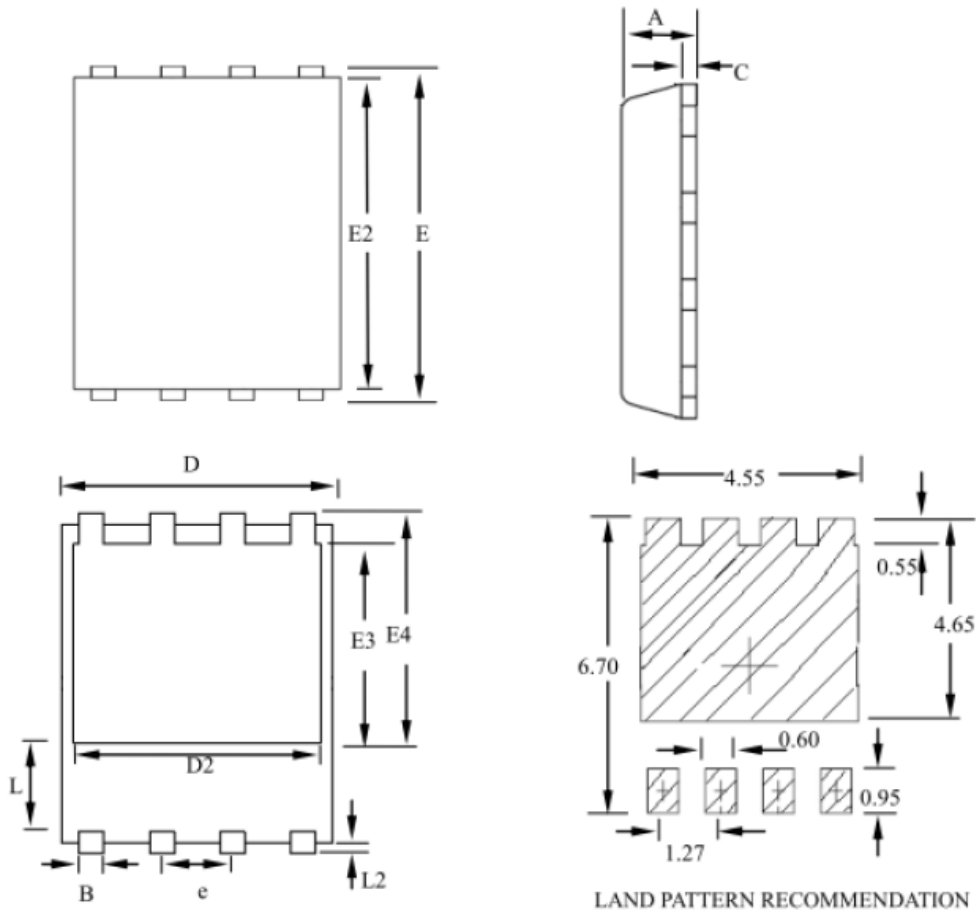

Fig.11 Unclamped Inductive Switching Waveform

PRPAK5X6 Package Outline Dimensions



SYMBOLS	MILLIMETERS			INCHES		
	MIN	NOM	MAX	MIN	NOM	MAX
A	0.80	--	1.20	0.031	--	0.047
B	0.30	--	0.51	0.012	--	0.020
C	0.15	--	0.35	0.006	--	0.014
D	4.80	--	5.30	0.189	--	0.209
D2	3.61	--	4.35	0.142	--	0.171
E	5.90	--	6.35	0.232	--	0.250
E2	5.42	--	5.90	0.213	--	0.232
E3	3.23	--	3.90	0.127	--	0.154
E4	3.69	--	4.55	0.145	--	0.179
L	0.61	--	1.80	0.024	--	0.071
L2	0.05	--	0.36	0.002	--	0.014
e	--	1.27	--	--	0.050	--