



Surface Mount Fast Recovery Rectifiers

Reverse Voltage - 50 to 1000 V

Forward Current - 1 A

FEATURES

- For surface mounted applications
- Low profile package
- Glass Passivated Chip Junction
- Easy to pick and place
- Fast reverse recovery time
- Lead free in comply with EU RoHS 2011/65/EU directives

MECHANICAL DATA

- Case: SMAF
- Terminals: Solderable per MIL-STD-750, Method 2026
- Approx. Weight: 27mg / 0.00095oz

PINNING

PIN	DESCRIPTION
1	Cathode
2	Anode

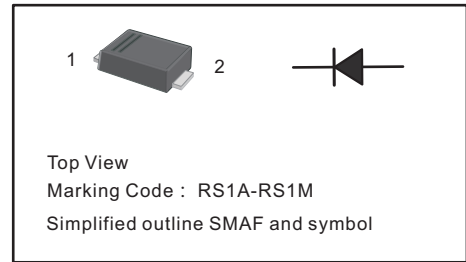

Absolute Maximum Ratings and Characteristics

Ratings at 25 °C ambient temperature unless otherwise specified. Single phase, half wave, 60 Hz, resistive or inductive load. For capacitive load, derate current by 20%.

Parameter	Symbols	RS1AF	RS1BF	RS1DF	RS1GF	RS1JF	RS1KF	RS1MF	Units
Maximum Repetitive Peak Reverse Voltage	V_{RRM}	50	100	200	400	600	800	1000	V
Maximum RMS voltage	V_{RMS}	35	70	140	280	420	560	700	V
Maximum DC Blocking Voltage	V_{DC}	50	100	200	400	600	800	1000	V
Maximum Average Forward Rectified Current at $T_c = 125\text{ }^\circ\text{C}$	$I_{F(AV)}$	1							A
Peak Forward Surge Current 8.3 ms Single Half Sine Wave Superimposed on Rated Load	I_{FSM}	30							A
Maximum Forward Voltage at 1 A	V_F	1.3							V
Maximum DC Reverse Current at Rated DC Blocking Voltage $T_a = 25\text{ }^\circ\text{C}$ $T_a = 125\text{ }^\circ\text{C}$	I_R	5 50							μA
Typical Junction Capacitance at $V_R=4\text{V}$, $f=1\text{MHz}$	C_j	15							pF
Maximum Reverse Recovery Time ⁽¹⁾	t_{rr}	150				250	500		ns
Typical Thermal Resistance ⁽²⁾	$R_{\theta JA}$ $R_{\theta JL}$	80 30							$^\circ\text{C/W}$
Operating and Storage Temperature Range	T_j, T_{stg}	-55 ~ +150							$^\circ\text{C}$

(1) Measured with $I_F = 0.5\text{ A}$, $I_R = 1\text{ A}$, $I_{rr} = 0.25\text{ A}$.

(2) P.C.B. mounted with 2.0" X 2.0" (5 X 5 cm) copper pad areas.



Fig.1 Forward Current Derating Curve

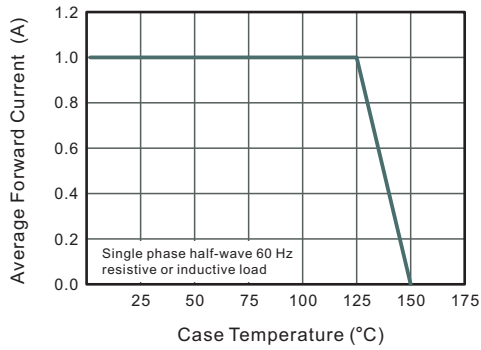

Fig.2 Typical Reverse Characteristics

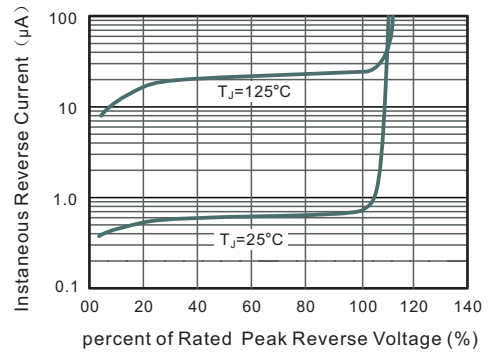

Fig.3 Typical Instantaneous Forward Characteristics

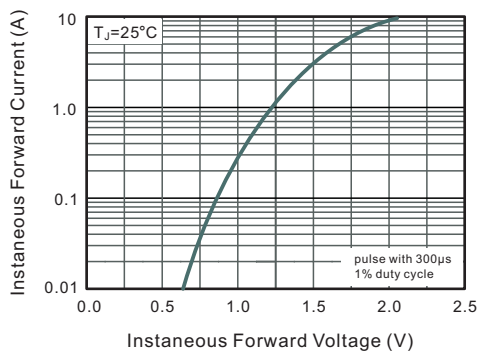

Fig.4 Typical Junction Capacitance

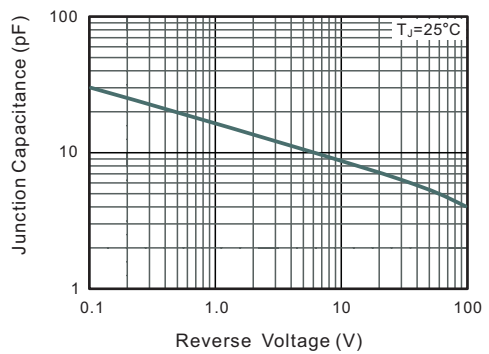
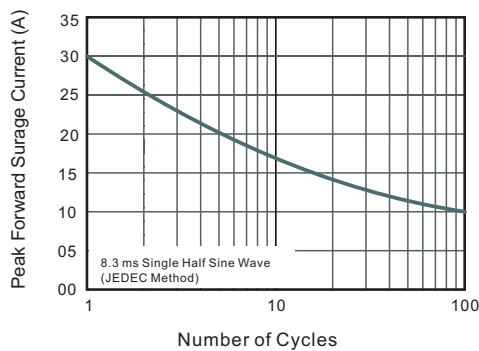

Fig.5 Maximum Non-Repetitive Peak Forward Surge Current





PACKAGE OUTLINE

Plastic surface mounted package; 2 leads

SMAF

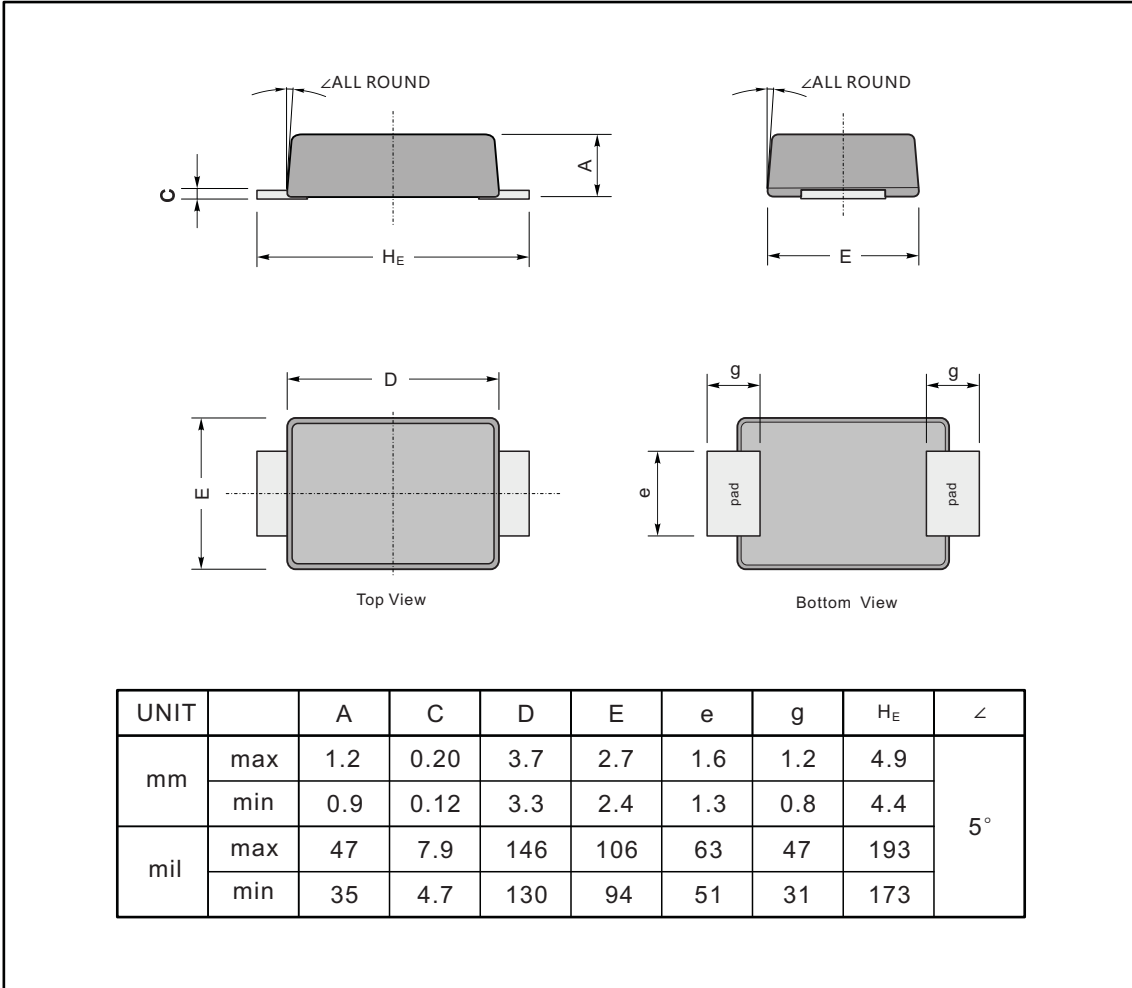

The recommended mounting pad size

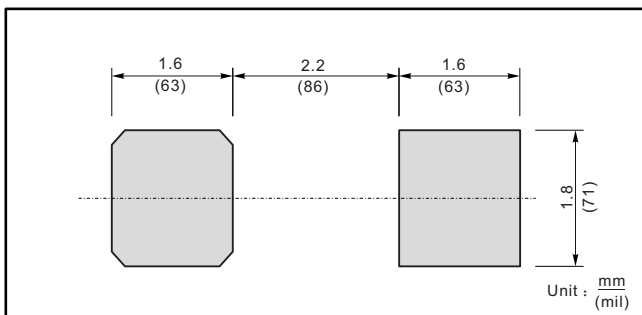

Marking

Type number	Marking code
RS1AF	RS1A
RS1BF	RS1B
RS1DF	RS1D
RS1GF	RS1G
RS1JF	RS1J
RS1KF	RS1K
RS1MF	RS1M