

3.0mm×2.0mm SMD Light Touch Switches

Type: **EVPAW**

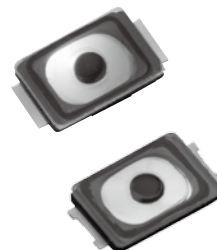

■ Features

- External dimensions : 3.0mm×2.0mm, Height 0.6mm
- High operability
Equipped with an actuator (push plate)
- IP67 characteristic

■ Recommended Applications

- Operation switches for portable electronic equipment
(Mobile phone, Portable audio)

■ Explanation of Part Numbers

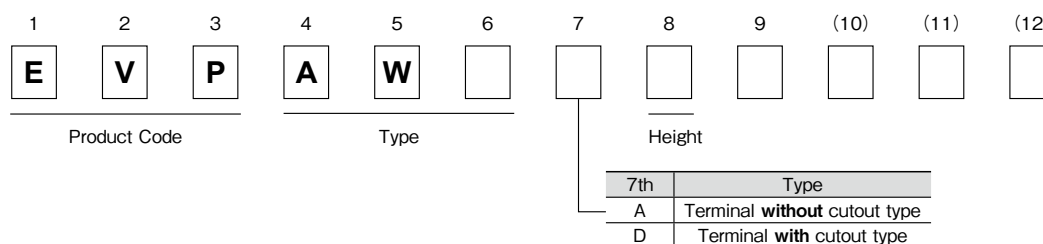

■ specification

Type	Snap action / Push-on type SPST	
Electrical	Rating	10μA 2V DC to 20mA 15V DC (Resistive load)
	Contact Resistance	500mΩ max.
	Insulation Resistance	50MΩ min. (at 100V DC)
	Dielectric Withstanding Voltage	250V AC for 1 minute
	Bouncing	10ms max. (ON, OFF)
Mechanical	Operating Force	1.6N, 2.4N, 3.3N
	Travel	1.6N, 2.4N : 0.13 mm 3.3N : 0.15 mm
Endurance	Operating Life	1.6N, 2.4N : 500000cycles min. 3.3N : 300000cycles min.
IP67 (*1)	IP6x (Dust resistance)	Dust : Talc (Type4) 8h
	IPx7 (Water resistance)	Immersion depth : 1m 30min.
Operating Temperature		-40°C to +85°C
Storage Temperature		-40°C~ +85°C (Bulk) -20°C~ +60°C (Taping)
Minimum Quantity/Packing Unit		10000 pcs. Embossed Taping (Reel Pack)
Quantity/Carton		50000 pcs.

Note: Non washable

(*1) IP67 : Switch shall not be operated during test.

Water or dust ingress shall be limited enough to prevent deleterious effect to the switch function.

However, IP67 shall be guaranteed under single product state,

then there is a possibility that IP67 performance become impaired depending on your mounting condition or usage.

So, please ask us in advance, if the switch is applied to important usage for water and dust resistant.

■ Dimensions in mm (not to scale)

EVPAW

(Embossed Taping)
Terminal without cutout type

General dimension tolerance : ± 0.05
() dimensions are reference dimensions.

This reference specifications are subject to change.

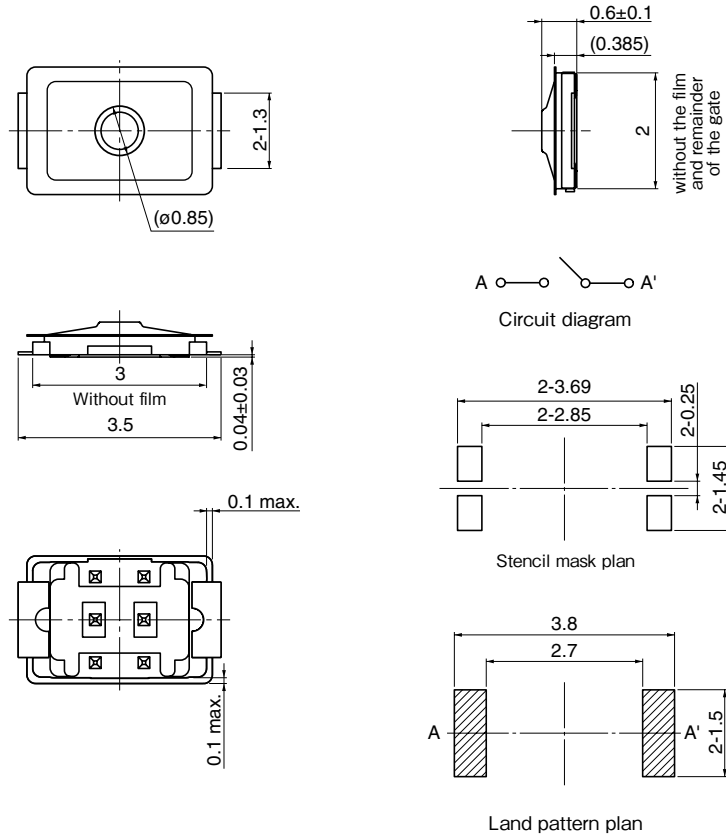
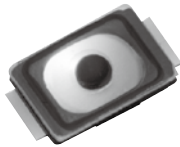

Soldering thickness $t=0.08 \pm 0.01$

*Soldering failure may occur depending on applied solder amount, so, please consider to use our recommended stencil and land pattern desing.

Part Numbers	Operating Force	Height	Operating Life
EVPAWBA2A	1.6N	0.6mm	50000cycles
EVPAWCA2A	2.4N	0.6mm	50000cycles
EVPAWEA2A	3.3N	0.6mm	30000cycles

■ Dimensions in mm (not to scale)

EVPAW

(Embossed Taping)
Terminal with cutout type

General dimension tolerance : ± 0.05
() dimensions are reference dimensions.
This reference specifications are subject to change.

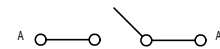
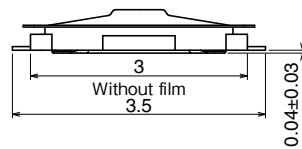
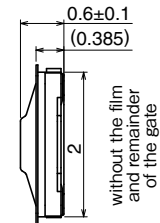
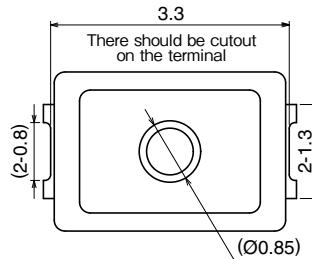

Circuit diagram

The thickness of the solder stencil shall be 0.1mm, and the opening ratio of the solder stencil to a land pattern shall be 60~100% (recommend 80%).

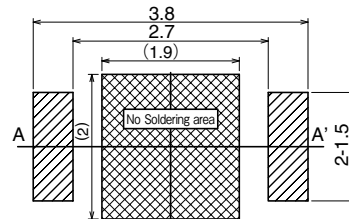
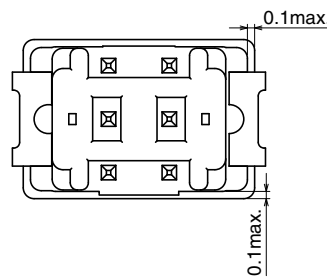
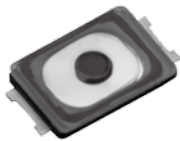

Land pattern plan

*Soldering failure may occur depending on applied solder amount, so, please consider to use our recommended stencil and land pattern desing.

▨ : Recommended land pattern area
▩ : No soldering area

- Any land pattern or via holes shall not be provided at ▩ area.
- If it's necessary to design land pattern or via holes at ▩ area, please apply resist to them to protect their metal part completely.
- If their metal parts are not protected completely, short circuit failure may occur,
- Besides, there should be convexoconcave by designing additional pattern, it may cause switch tilt, influence on solder-ability or flux intrusion after reflow soldering.
- Therefore, please study any influence of addition land pattern or via holes at ▩ area in advance.

Part Numbers	Operating Force	Height	Operating Life
EVPAWBD2A	1.6N	0.6mm	50000cycles
EVPAWCD2A	2.4N	0.6mm	50000cycles
EVPAWED2A	3.3N	0.6mm	30000cycles

Recommended Reflow Soldering Conditions

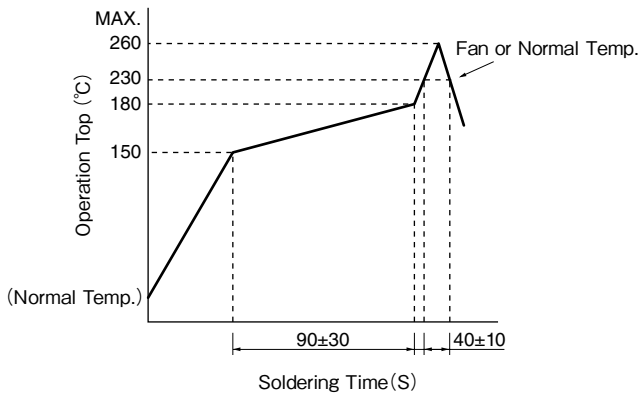

* Reflow temperature may vary by location even in the same reflow condition.
Please check the reflow temperature at terminals and at the top of a switch to make sure the both temperatures are within the specification.
If even one of them is out of the specifications, please adjust.

Embossed Carrier Taping

Tape width=12.0 mm

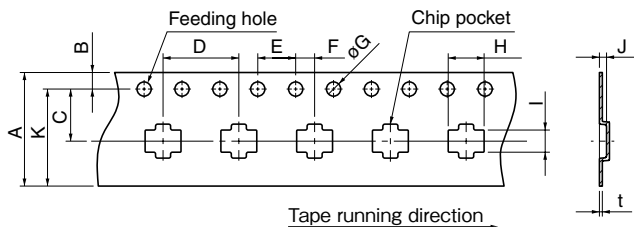

- Taping condition: Lack of products in the middle of taping should be one MAX, but total quantity specified in the specifications should be secured.
- Peeling off strength of top tape: It should be within 0.2N to 1.0N at 165 degree in peeling off angle.
- Joint of carrier tape: One joint per one reel may exist.

Unit : mm

Part No.	Height	A	B	C	D	E	F	G	H	I	J	K	t
EVPAW	0.6	12.0±0.3	1.75±0.1	5.5±0.1	8.0±0.1	4.0±0.1	2.0±0.1	1.5±0.3	3.8±0.2	2.3±0.2	0.75±0.2	(10.25)	0.3 ^{+0.15} _{-0.10}

Standard Reel Dimensions in mm (not to scale)

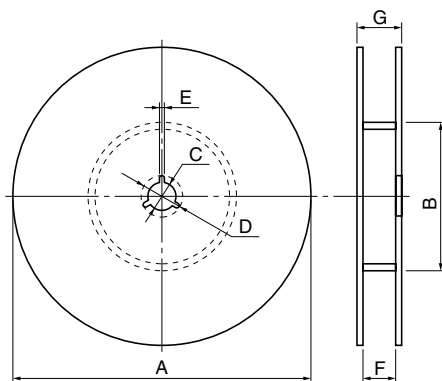

Item	A	B	C	D	E
Rate (mm)	ø380.0±2.0	ø80.0±1.0	ø13.0±0.5	ø21.0±1.0	2.0±0.5

Item	F	G
Rate (mm)	13.5±1.0	17.5±1.0