

SMD3225-4 Crystal Resonator

7B013560I01

1. Scope:

- 1.1 This specification applies to the RoHS compliance quartz crystal unit with a frequency of 13.560MHz which will be used in crystal oscillator applications.

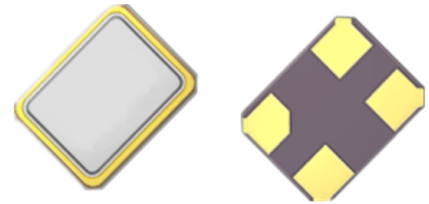

2. Construction:

- 2.1 Type of Quartz Resonator: SMD3225-4pads

3. Electrical Characteristics

- | | |
|---|----------------------|
| 3.1 Nominal Frequency(f): | 13.560MHz |
| 3.2 Load Capacitance(C_L): | 10pF |
| 3.3 Frequency Tolerance($\Delta f/f$): | ± 10 ppm |
| 3.4 Frequency Temperature Stability: | ± 20 ppm |
| 3.5 Resonance Resistance(ohm): | 50 ohms Max |
| 3.6 Osc mode: | Fundamental mode |
| 3.7 Shunt Capacitance(C_0): | 2pF Max |
| 3.8 Drive Level(D_L): | 100 μ W Max |
| 3.9 Operating Temperature Range(T_{OPR}): | -20 to + 70°C |
| 3.10 Storage Temperature Range(T_{STG}): | -55 to + 125°C |
| 3.11 Insulation Resistance(IR): | > 500M ohms |
| 3.12 Aging(Δf_A): | ± 3 ppm/Year Max |

Reliability Specification

	Item	Condition	Standard
1.	Drop characteristics	Free drop from 75cm height on a hard wooden board for 3 times. (Board is thickness more than 30 mm.)	Frequency change: $\leq \pm 5\text{ppm}$ Rr as specification
2.	Mechanical shock	Device are shocked to half sine wave (1000g) three mutually perpendicular axes each 3 times	Frequency change: $\leq \pm 5\text{ppm}$ Rr as specification
3.	Shake characteristics	Shake frequency 10~55Hz, cyc1~2 minutes, swing 1.5mm, direction x/y/z, all 30 minutes, test after 1 hours.	Frequency change: $\leq \pm 5\text{ppm}$ Rr as specification
4.	Humidity characteristics	$+40 \pm 2^\circ\text{C}$ & 90%~95% R.H. 250 hours	Frequency change: $\leq \pm 5\text{ppm}$ Rr as specification
5.	Low temperature characteristics	$-40 \pm 2^\circ\text{C}$, 250 hours, put in room temperature, test after 1 hours.	Frequency change: $\leq \pm 5\text{ppm}$ Rr as specification
6.	High temperature characteristics	$+85 \pm 2^\circ\text{C}$, 250 hours, put in room temperature, test after 1 hours.	Frequency change: $\leq \pm 5\text{ppm}$ Rr as specification
7.	Temperature cycling	$-30 \pm 3^\circ\text{C}/30 \pm 3 \text{ min} \sim +85 \pm 2^\circ\text{C}/30 \pm 3\text{min}$, 5 cycles	Frequency change: $\leq \pm 5\text{ppm}$ Rr as specification
8.	Refluence examination	<p>1. Max 180sec 2. Max 10 sec 3. Max 80 sec 4. Max 90 sec</p>	Frequency change: $\leq \pm 5\text{ppm}$ Rr as specification

Package Outline Dimensions



Bottom View

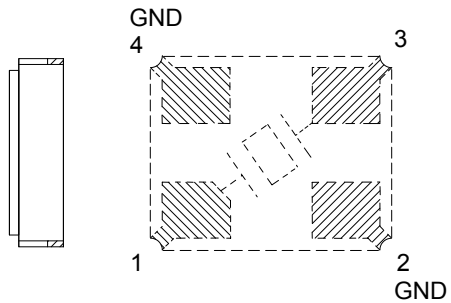

Internal View Connection

引脚	功能
#1	CRYSTAL
#2	GND
#3	CRYSTAL
#4	GND

Units:mm

Suggested Pad Layout



Units:mm

Packing Specification

