

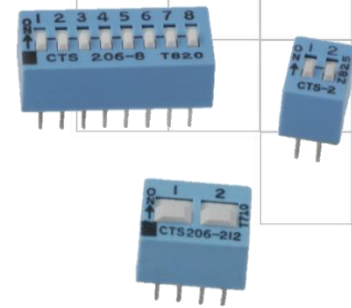

Series 206 Through-Hole DIP Switch

- Available with SPST, SPDT, DPST, 3PST circuit choices
- Available with low profile, standard, or extended actuator heights. Consult the ordering information for options.
- Blue housing
- RoHS compliant
- Optional top tape seal for board spray washing
- Gold plated contacts



Description

The terminals are molded into the thermoset base and provide an electrostatic discharge shield rating to 22KV when front row of terminals are connected to ground. The optimized contact design incorporating a dimple-to-flat surface wiping interface for long-term contact corrosion resistance, making it the ideal choice for any circuit breaker and HVAC applications.

Ordering Information

Series	Number of Poles	Number of Throws	Number of Switch Positions	Actuator Height	Bottom Epoxy Seal	Top Tape Seal	Actuation Preset																																													
206-	1	2	1	E	S	T	N																																													
	↓	↓	↓	↓	↓	↓	↓																																													
	<table border="1"> <thead> <tr> <th>Code</th> <th>No. of poles</th> </tr> </thead> <tbody> <tr> <td>Blank</td> <td>For SPST</td> </tr> <tr> <td>1</td> <td>Single pole</td> </tr> <tr> <td>2</td> <td>Double pole</td> </tr> <tr> <td>3</td> <td>3 poles</td> </tr> </tbody> </table>	Code	No. of poles	Blank	For SPST	1	Single pole	2	Double pole	3	3 poles	<table border="1"> <thead> <tr> <th>Code</th> <th>No. of switch positions</th> </tr> </thead> <tbody> <tr> <td>1</td> <td>1 position</td> </tr> <tr> <td>2</td> <td>2 positions</td> </tr> <tr> <td>3</td> <td>3 positions</td> </tr> <tr> <td>4</td> <td>4 positions</td> </tr> <tr> <td>5</td> <td>5 positions</td> </tr> <tr> <td>6</td> <td>6 positions</td> </tr> <tr> <td>7</td> <td>7 positions</td> </tr> <tr> <td>8</td> <td>8 positions</td> </tr> <tr> <td>9</td> <td>9 positions</td> </tr> <tr> <td>10</td> <td>10 positions</td> </tr> <tr> <td>12</td> <td>12 positions</td> </tr> </tbody> </table>	Code	No. of switch positions	1	1 position	2	2 positions	3	3 positions	4	4 positions	5	5 positions	6	6 positions	7	7 positions	8	8 positions	9	9 positions	10	10 positions	12	12 positions	<table border="1"> <thead> <tr> <th>Code</th> <th>Spec.</th> </tr> </thead> <tbody> <tr> <td>Blank</td> <td>Standard (0.89mm/.035")</td> </tr> <tr> <td>E</td> <td>Extended (3.43mm/.135") (SPST only)</td> </tr> <tr> <td>LP</td> <td>Low profile (Flush) (SPST & SPDT only)</td> </tr> </tbody> </table>	Code	Spec.	Blank	Standard (0.89mm/.035")	E	Extended (3.43mm/.135") (SPST only)	LP	Low profile (Flush) (SPST & SPDT only)	<table border="1"> <thead> <tr> <th>Code</th> <th>Top tape seal</th> </tr> </thead> <tbody> <tr> <td>Blank</td> <td>No top tape seal</td> </tr> <tr> <td>T</td> <td>Top tape seal (Not available for extended actuator or 1-position SPST DIP switch)</td> </tr> </tbody> </table>	Code	Top tape seal	Blank	No top tape seal	T	Top tape seal (Not available for extended actuator or 1-position SPST DIP switch)
Code	No. of poles																																																			
Blank	For SPST																																																			
1	Single pole																																																			
2	Double pole																																																			
3	3 poles																																																			
Code	No. of switch positions																																																			
1	1 position																																																			
2	2 positions																																																			
3	3 positions																																																			
4	4 positions																																																			
5	5 positions																																																			
6	6 positions																																																			
7	7 positions																																																			
8	8 positions																																																			
9	9 positions																																																			
10	10 positions																																																			
12	12 positions																																																			
Code	Spec.																																																			
Blank	Standard (0.89mm/.035")																																																			
E	Extended (3.43mm/.135") (SPST only)																																																			
LP	Low profile (Flush) (SPST & SPDT only)																																																			
Code	Top tape seal																																																			
Blank	No top tape seal																																																			
T	Top tape seal (Not available for extended actuator or 1-position SPST DIP switch)																																																			
	<table border="1"> <thead> <tr> <th>Code</th> <th>Spec.</th> </tr> </thead> <tbody> <tr> <td>Blank</td> <td>For SPST</td> </tr> <tr> <td>1</td> <td>Single throw</td> </tr> <tr> <td>2</td> <td>Double throw</td> </tr> </tbody> </table>	Code	Spec.	Blank	For SPST	1	Single throw	2	Double throw	<table border="1"> <thead> <tr> <th>Code</th> <th>Spec.</th> </tr> </thead> <tbody> <tr> <td>Blank</td> <td>Ship at OFF position</td> </tr> <tr> <td>N</td> <td>Ship at ON position (SPST, DPST & 3PST only)</td> </tr> </tbody> </table>	Code	Spec.	Blank	Ship at OFF position	N	Ship at ON position (SPST, DPST & 3PST only)	<table border="1"> <thead> <tr> <th>Code</th> <th>Bottom epoxy seal</th> </tr> </thead> <tbody> <tr> <td>Blank</td> <td>No epoxy seal</td> </tr> <tr> <td>S</td> <td>Epoxy seal (Required for 206-1S)</td> </tr> </tbody> </table>	Code	Bottom epoxy seal	Blank	No epoxy seal	S	Epoxy seal (Required for 206-1S)																													
Code	Spec.																																																			
Blank	For SPST																																																			
1	Single throw																																																			
2	Double throw																																																			
Code	Spec.																																																			
Blank	Ship at OFF position																																																			
N	Ship at ON position (SPST, DPST & 3PST only)																																																			
Code	Bottom epoxy seal																																																			
Blank	No epoxy seal																																																			
S	Epoxy seal (Required for 206-1S)																																																			

- Notes: 1.Contact CTS for other common features not listed.
2. Not available in a Double Pole Double Throw (DPDT) construction



Electrical Specifications

Parameter	Conditions & Remarks	Min	Max	Unit
Contact Resistance	Initial		50	milliohms
	At end of life		100	
Insulation Resistance	Between insulated terminals	1000		Megohms
Dielectric Strength	500 VAC between adjacent switches		1	minute
Switch Capacitance	Between adjacent closed switches		5.0	pF
Nonswitching Rating			100	mA
			50	or VDC
Circuit	SPST	1	12	Position
	SPDT	1	6	Position
	DPST	1	6	Position
	3PST	1	4	Position

Mechanical and Environmental

Actuation Life (206)	10,000 cycles switching 50mA @ 24VDC
Soldering	Maximum wave temperature, 260°C for 5 seconds
Shock	Per MIL-STD-202F, method 213B, condition A(50G's) with no contact inconsistencies greater than 1 microsecond
Vibration	Per MIL-STD-202F, method 204D, condition B (.06" or 15G's between 10 HZ to 2K HZ) with no contact inconsistencies greater than 1 microsecond
Seal	Bottom epoxy seal optional Optional top tape seal for board spray washing
Marking	Special side or top marking available-consult CTS
Packaging:	Standard anti-static tube packaging
Operating Temperature Range	-55°C to +85°C
Storage Temperature Range	-55°C to +85°C

Mechanical Specifications

Figure 1 - SPST

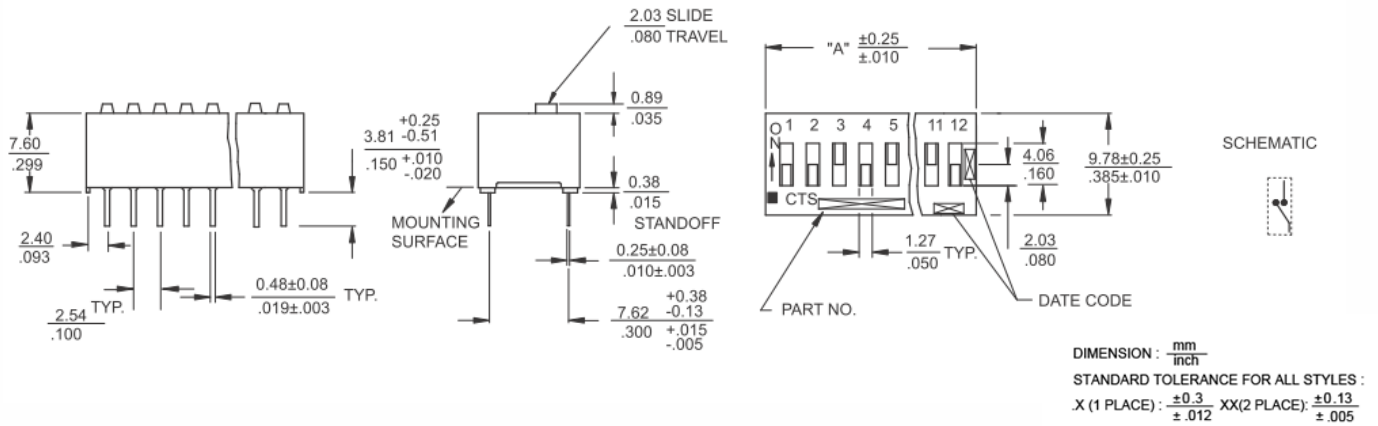

Figure 2 – SPDT

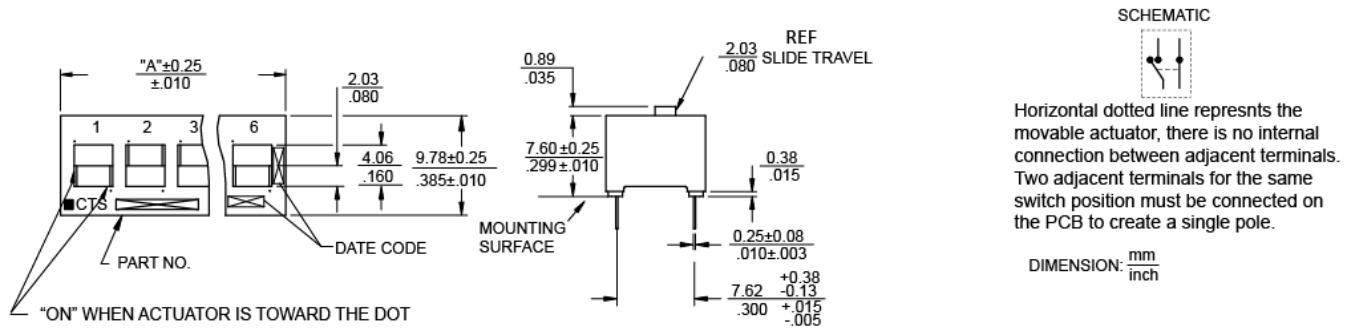

Figure 3 – DPST

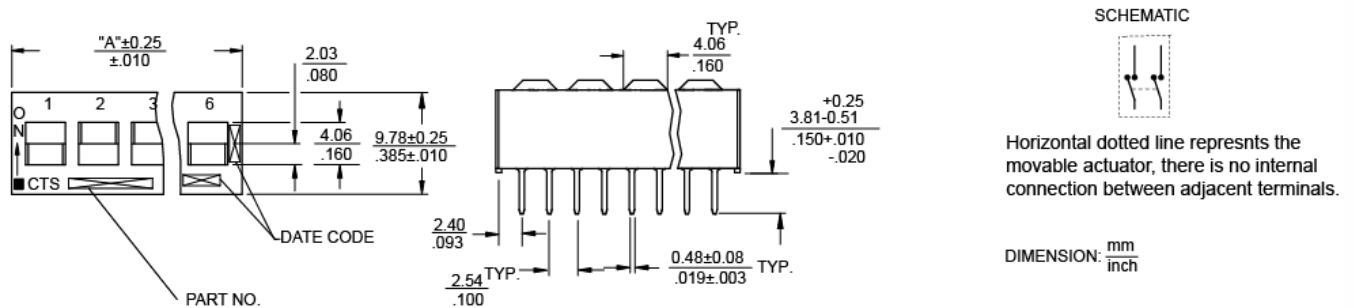

Figure 4 - 3PST

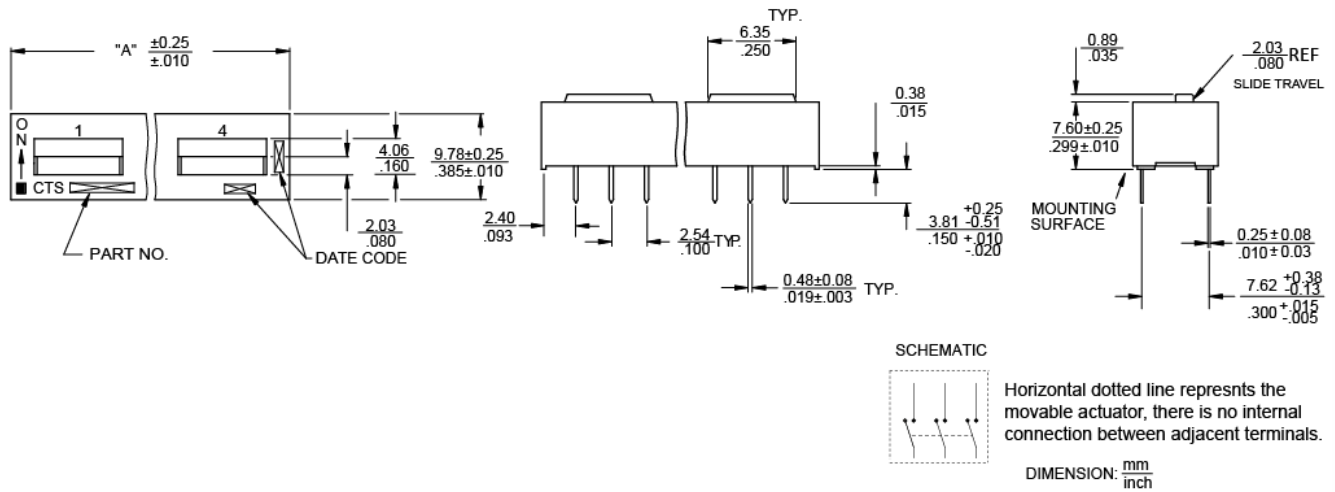

Figure 5 – Low Profile Actuators (SPST & SPDT only)

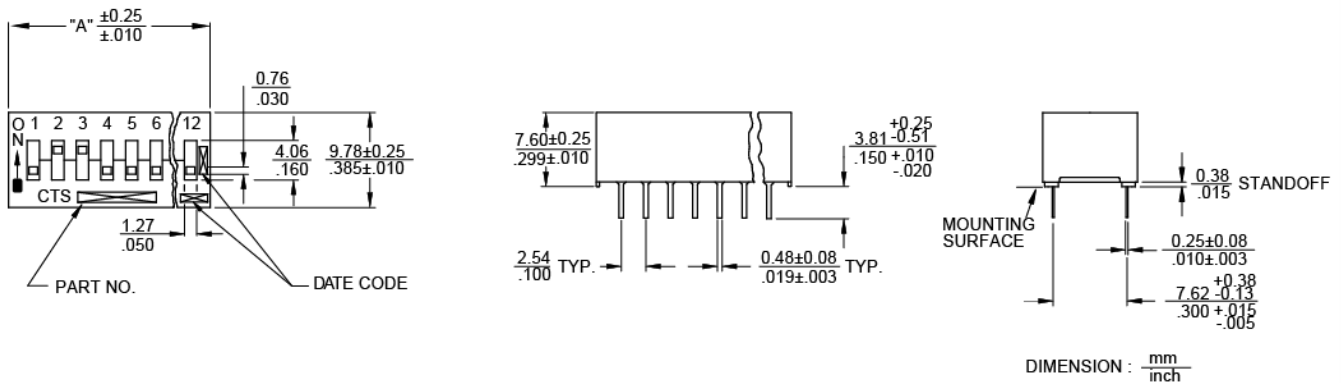
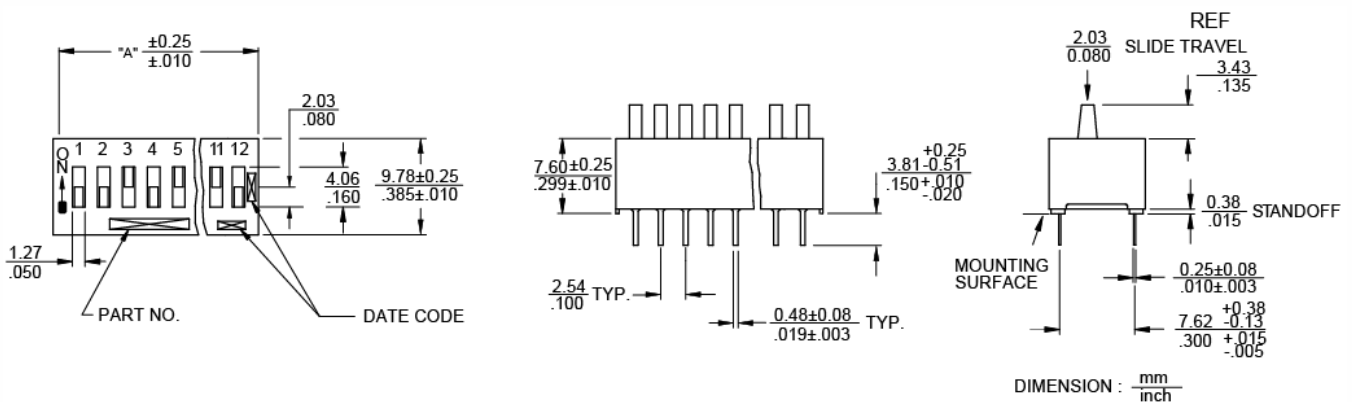

Figure 6 – Extended Actuators (SPST only)





"A" Overall Dimensions	Number of Switch Positions	Actuation	Part Number	Both Bottom and Top Sealed	Low Profile Both Bottom and Top Sealed
3.96 / .156	2	SPST	206-1S	-	-
7.26 / .286	3	SPST	206-2	206-2ST	206-2LPST
9.80 / .386	4	SPST	206-3	206-3ST	206-3LPST
12.34 / .486	5	SPST	206-4	206-4ST	206-4LPST
14.88 / .586	6	SPST	206-5	206-5ST	206-5LPST
17.42 / .686	7	SPST	206-6	206-6ST	206-6LPST
19.96 / .786	8	SPST	206-7	206-7ST	206-7LPST
22.50 / .886	9	SPST	206-8	206-8ST	206-8LPST
25.04 / .986	10	SPST	206-9	206-9ST	206-9LPST
27.58 / 1.086	12	SPST	206-10	206-10ST	206-10LPST
32.66 / 1.286		SPST	206-12	206-12ST	206-12LPST
7.26 / .286	1	SPDT	206-121	206-121ST	206-121LPST
12.34 / .486	2	SPDT	206-122	206-122ST	206-122LPST
17.42 / .686	3	SPDT	206-123	206-123ST	206-123LPST
22.50 / .886	4	SPDT	206-124	206-124ST	206-124LPST
27.58 / 1.086	5	SPDT	206-125	206-125ST	206-125LPST
32.66 / 1.286	6	SPDT	206-126	206-126ST	206-126LPST
7.26 / .286	1	DPST	206-211	206-211ST	
12.34 / .486	2	DPST	206-212	206-212ST	
17.42 / .686	3	DPST	206-213	206-213ST	
22.50 / .886	4	DPST	206-214	206-214ST	
27.58 / 1.086	5	DPST	206-215	206-215ST	
32.66 / 1.286	6	DPST	206-216	206-216ST	
9.80 / .386	1	3PST	206-311	206-311ST	
17.42 / .686	2	3PST	206-312	206-312ST	
25.04 / .986	3	3PST	206-313	206-313ST	
32.66 / 1.286	4	3PST	206-314	206-314ST	