

# GR3AB THRU GR3MB Fast Recovery Rectifier

## Features

- High efficiency
- High current capability
- High reliability
- High surge current capability
- Low power loss
- Glass passivated chip junction
- Solder dip 265 °C max. 10 s, per JESD 22-B106

## Typical Applications

For use in general purpose rectification of power supplies, inverters, converters, and freewheeling diodes for consumer, and telecommunication.

## Mechanical Data

- Package:SMB
- Molding compound meets UL 94 V-0 flammability rating, RoHS-compliant
- Terminals: Tin plated leads, solderable per J-STD-002 and JESD22-B102
- Polarity:Color band denotes cathode end

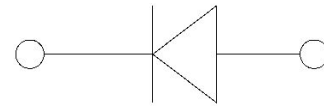
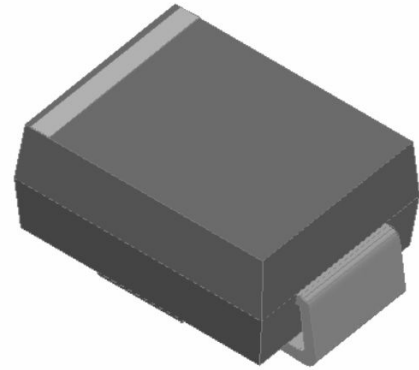

## ■ Maximum Ratings (Ta=25°C Unless otherwise specified)

PARAMETER	Symbol	Unit	GR3						
			AB	BB	DB	GB	JB	KB	MB
Maximum Repetitive Peak Reverse Voltage	V <sub>RRM</sub>	V	50	100	200	400	600	800	1000
Maximum RMS Voltage	V <sub>RMS</sub>	V	35	70	140	280	420	560	700
Maximum DC blocking Voltage	V <sub>DC</sub>	V	50	100	200	400	600	800	1000
Average Forward Current @Half-sine wave, Resistance load, Tc(Fig.1)	I <sub>o</sub>	A	3.0						
Forward Surge Current (Non-repetitive) @60HZ sine wave, 1 cycle, Ta=25°C	I <sub>FSM</sub>	A	100						
Current squared time @1ms≤t8.3≤ms Ta=25°C, Rating of per diode	I <sup>2</sup> t	A <sup>2</sup> s	41.5						
Thermal Resistance(Typical) @Between junction and ambient	R <sub>θJ-A</sub>	°C/W	55						
Storage Temperature	T <sub>stg</sub>	°C	-55 ~ +150						
Junction Temperature	T <sub>j</sub>	°C	-55 ~ +150						

## ■ Electrical Characteristics (Ta=25°C Unless otherwise specified)

PARAMETER	Symbol	Unit	Conditions	GR3						
				AB	BB	DB	GB	JB	KB	MB
Peak Forward Voltage	V <sub>FM</sub>	V	I <sub>F</sub> =3.0A	1.3						
Peak Reverse Current	I <sub>RRM</sub>	μA	VR =V <sub>DC</sub> @Ta=25°C	5						
			VR =V <sub>DC</sub> @Ta=125°C	200						
Maximum reverse recovery time	T <sub>rr</sub>	ns	I <sub>F</sub> =0.5A,I <sub>R</sub> =1.0A, I <sub>rr</sub> =0.25A	150			250		500	



# GR3AB THRU GR3MB

## ■ Characteristics (Typical)

FIG.1: Io-TL Curve

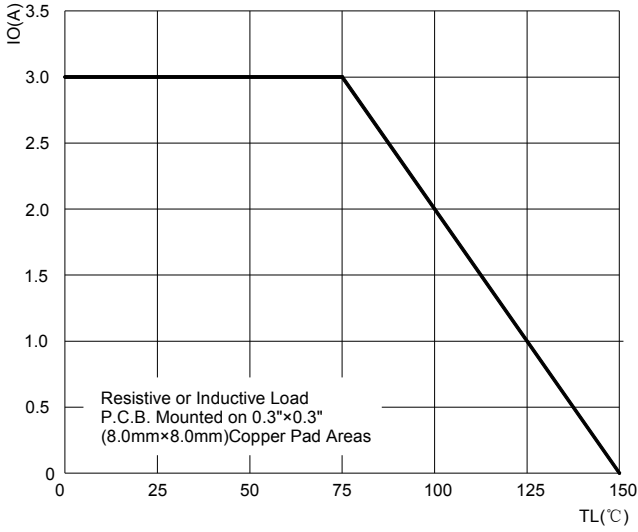

FIG.2: Forward Surge Current Capability

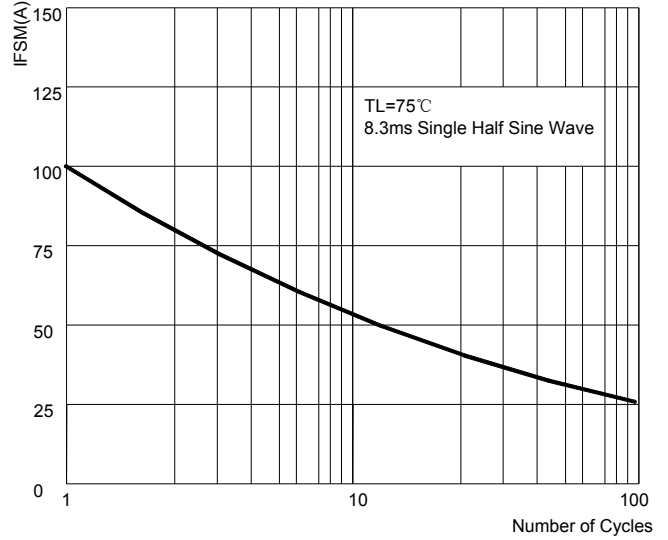

FIG.3: Forward Voltage

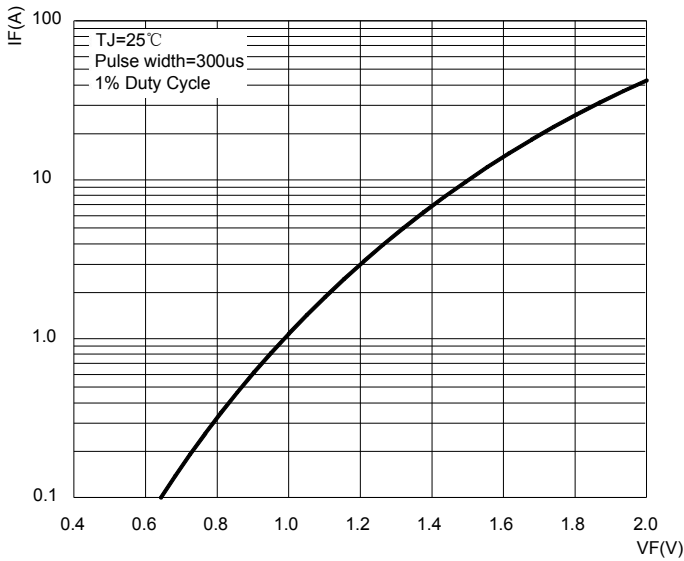

FIG.4: Typical Reverse Characteristics

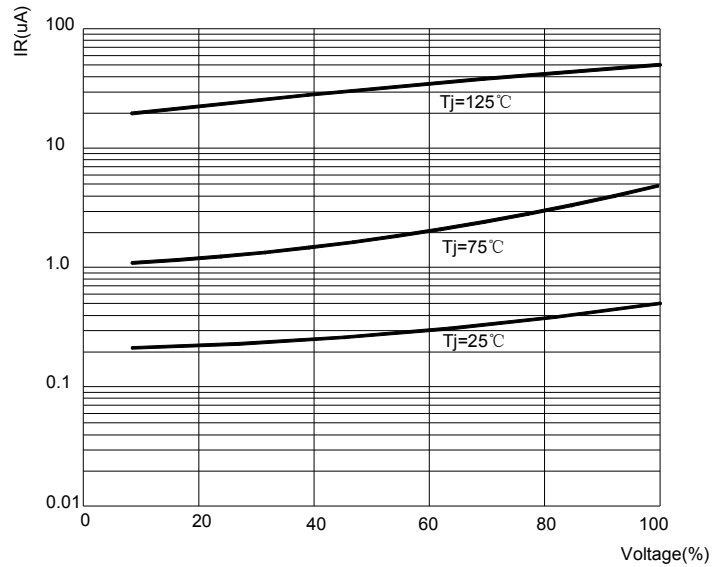
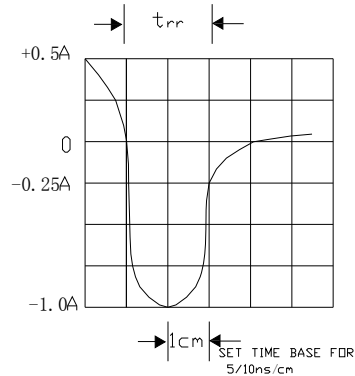
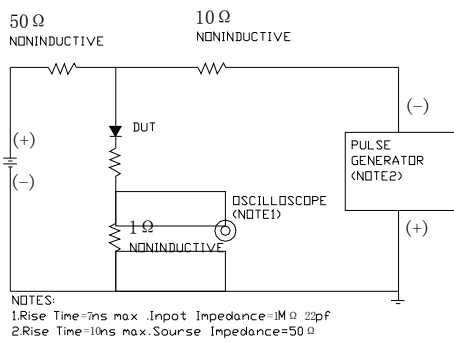

FIG.5: Diagram of circuit and Testing wave form of reverse recovery time



# GR3AB THRU GR3MB

## ■ Ordering Information (Example)

PREFERED	PACKAGE CODE	MINIMUM PACKAGE(pcs)	INNER BOX QUANTITY(pcs)	OUTER CARTON QUANTITY(pcs)	DELIVERY MODE
GR3AB THRU GR3MB	SMB	3000	6000	48000	13"reel

## ■ Outline Dimensions

