



Photocoupler
Product Data Sheet
LTV-M601 Series

Spec No. :DS70-2013-0020
Effective Date: 01/13/2021
Revision: G

LITE-ON DCC

RELEASE

BNS-OD-FC001/A4

Photocoupler LTV-M601 series

Small Outline, 5Lead, High CMR

1. DESCRIPTION

The LTV-M601 series consists of a high efficient AlGaAs Light Emitting Diode and a high speed optical detector. This unique design provides maximum AC and DC circuit isolation while achieving LVTTTL/LVCMOS compatibility. The output of the optical detector features an open collector Schottky clamped transistor. The internal shield provides a guaranteed common mode transient immunity specification of 10 KV/us at 3.3/5V operation. The Optocoupler operational parameters are guaranteed over the temperature range from -40°C ~ +85°C.

1.1 Features

- 3.3V / 5V Dual Supply Voltages
- Low power consumption
- High speed – 10MBd typical
- Low input current capability: 5mA
- 10KV/μs minimum Common Mode Rejection (CMR) at $V_{CM} = 1000V$
- Guaranteed AC and DC performance over temperature -40°C ~ +85°C.
- LVTTTL/LVCMOS Compatible.
- Strobable output.
- Safety approval

UL/ cUL 1577, 3750 Vrms/1 min

VDE DIN EN60747-5-5, $V_{IORM} = 567 V_{peak}$

1.2 Applications

- Isolation in line receivers
- Ground loop elimination
- Feedback Element in Switching Mode Power Supplier
- High Speed Logic Ground Isolation – TTL/TTL, TTL/CMOS, TTL/LSTTL
- Pulse transformer replacement
- Power transistor isolation in motor drives
- Interface between Microprocessor system, computer and their peripheral

Functional Diagram

Pin No. and Internal connection diagram

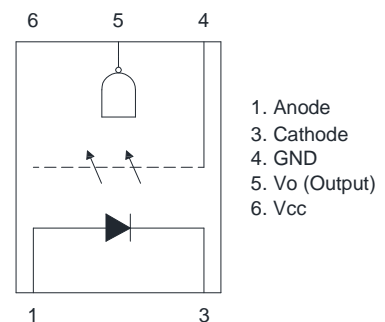

Truth Table (Positive Logic)

LED	OUT
ON	L
OFF	H

A 0.1μF bypass Capacitor must be connected between Pin4 and Pin6

Photocoupler LTV-M601 series

2. PACKAGE DIMENSIONS

2.1 LTV-M601 series

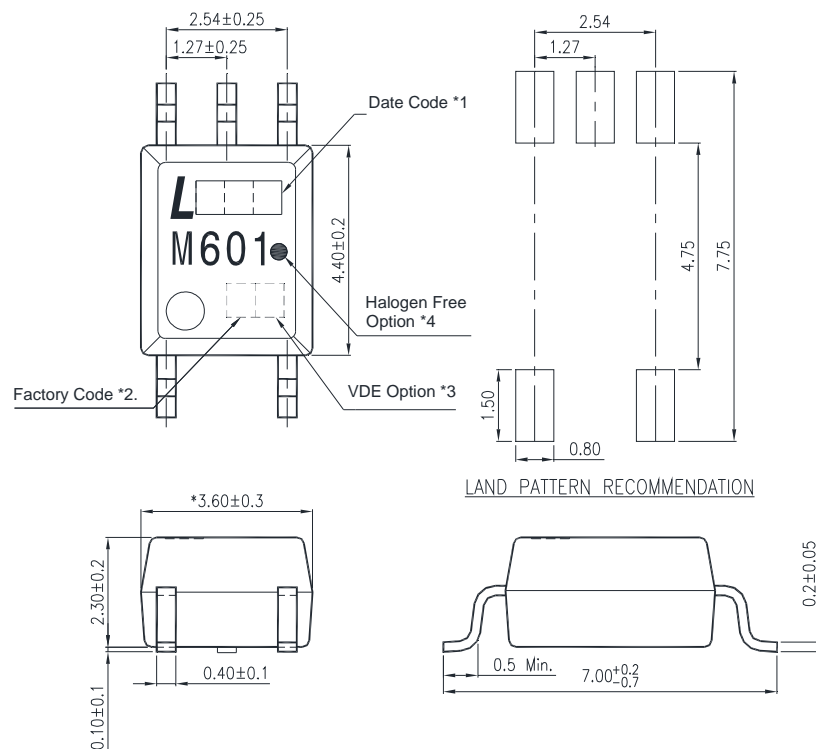

Notes :

1. The first digit is year date code, second and third digit is work week
2. Factory identification mark (W :China-CZ)
Dimensions are all in Millimeters.
3. "4" or "V" for VDE option.

* Dimensions are in Millimeters and (Inches).

Photocoupler LTV-M601 series

3. TAPING DIMENSIONS

3.1 LTV-M601

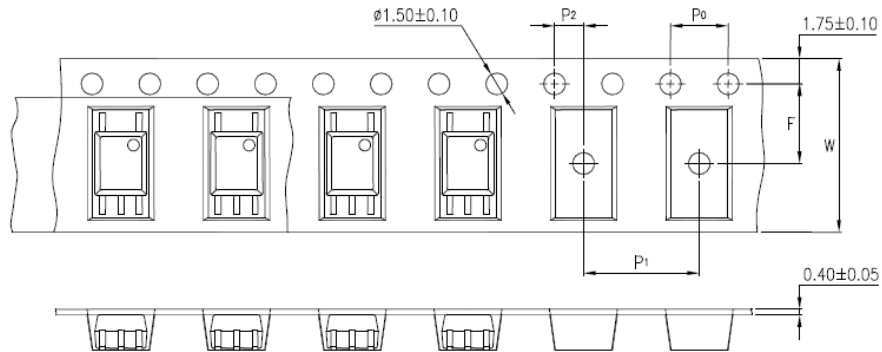

3.2 LTV-M601-TP

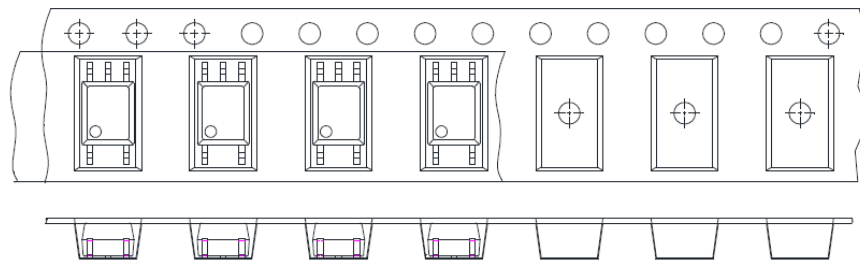

Description	Symbol	Dimension in mm (inch)
Tape wide	W	12 ± 0.3 (.472)
Pitch of sprocket holes	P ₀	4 ± 0.1 (.157)
Distance of compartment	F	5.5 ± 0.1 (.217)
	P ₂	2 ± 0.1 (.079)
Distance of compartment to compartment	P ₁	8 ± 0.1 (.315)

3.3 Quantities Per Reel

Package Type	LTV-M601 series
Quantities (pcs)	3000

Photocoupler LTV-M601 series

4. RATING AND CHARACTERISTICS

4.1 Absolute Maximum Ratings at Ta=25°C *

	Parameter	Symbol	Rating	Unit	Note
Input	Average Forward Input Current	I_F	20	mA	2
	Reverse Input Voltage	V_R	5	V	
	Power Dissipation	P_I	40	mW	
Output	Output Collector Current	I_O	50	mA	
	Output Collector Voltage	V_O	7	V	
	Output Collector Power Dissipation	P_O	85	mW	
	Isolation Voltage	V_{iso}	3750	V_{rms}	
	Supply Voltage	V_{CC}	7	V	
	Operating Temperature	T_{opr}	-40 ~ +85	°C	
	Storage Temperature	T_{stg}	-40 ~ +125	°C	
	Lead Solder Temperature **	T_{sol}	260	°C	

*Ambient temperature = 25°C, unless otherwise specified. Stresses exceeding the absolute maximum ratings can cause permanent damage to the device. Exposure to absolute maximum ratings for long periods of time can adversely affect reliability.

**260°C for 10 seconds. Refer to Lead Free Reflow Profile.

4.2 Recommended Operating Conditions

Parameter	Symbol	Min	Max	Unit
Operating Temperature	T_A	-40	85	°C
Supply Voltage	V_{CC}	2.7	3.6	V
		4.5	5.5	
Low Level Input Current	I_{FL}	0	250	μA
High Level Input Current	I_{FH}	5	15	mA
Output Pull-up Resistor	R_L	330	4k	Ω
Fan Out (at $R_L=1k\Omega$ per channel)	N	—	5	TTL Loads

Photocoupler LTV-M601 series

4.3 ELECTRICAL OPTICAL CHARACTERISTICS

Parameter	Symbol	Min.	Typ.	Max.	Unit	Test Condition	Fig.	Note
Input								
Input Forward Voltage	V_F	—	1.38	1.80	V	$I_F=10\text{mA}$, $T_A=25^\circ\text{C}$	7	
Input Forward Voltage Temperature Coefficient	$\Delta V_F/\Delta T$	—	-1.6	—	mV/°C	$I_F=10\text{mA}$		
Input Reverse Voltage	BV_R	5.0	—	—	V	$I_R = 10\mu\text{A}$		
Input Threshold Current	I_{TH}	—	1.5	5	mA	$V_{CC} = 3.3\text{V}$, $V_O = 0.6\text{V}$ $I_{OL} (\text{sinking}) = 13\text{mA}$	4	
Input Capacitance	C_{IN}	—	34	—	pF	$V_F=0$; $f=1\text{MHz}$		
Detector								
Logic low output voltage	V_{OL}	—	0.3	0.6	V	$V_{CC} = 3.3\text{V}$, $I_F = 5\text{mA}$, $I_{OL} (\text{sinking}) = 13\text{mA}$	5	
Logic high output current	I_{OH}	—	5	100	μA	$V_{CC} = 3.3\text{V}$, $V_O = 3.3\text{V}$, $I_F = 250\mu\text{A}$	3	
Logic low supply current	I_{CCL}	—	5.8	10	mA	$V_{CC} = 3.3\text{V}$, $I_F = 10\text{mA}$		1
Logic high supply current	I_{CCH}	—	3.8	7	mA	$V_{CC} = 3.3\text{V}$, $I_F = 0\text{mA}$		1

Specified over recommended temperature ($T_A = -40^\circ\text{C}$ to $+85^\circ\text{C}$, $2.7\text{V} \leq V_{CC} \leq 3.6\text{V}$), $I_F = 7.5\text{mA}$ unless otherwise specified. All typicals at $T_A = 25^\circ\text{C}$, $V_{CC} = 3.3\text{V}$.

Photocoupler LTV-M601 series

4.4 ELECTRICAL OPTICAL CHARACTERISTIC

Parameter	Symbol	Min.	Typ.	Max.	Unit	Test Condition	Fig.	Note
Input								
Input Forward Voltage	V_F	—	1.38	1.80	V	$I_F=10\text{mA}$, $T_A=25^\circ\text{C}$	7	
Input Forward Voltage Temperature Coefficient	$\Delta V_F/\Delta T$	—	-1.6	—	mV/°C	$I_F=10\text{mA}$		
Input Reverse Voltage	BV_R	5.0	—	—	V	$I_R = 10\mu\text{A}$		
Input Threshold Current	I_{TH}	—	1.57	5	mA	$V_{CC} = 5.5\text{V}$, $V_O=0.6\text{V}$ $I_{OL} \geq 13\text{mA}$	4	
Input Capacitance	C_{IN}	—	34	—	pF	$V_F=0$; $f=1\text{MHz}$		
Detector								
Logic low output voltage	V_{OL}	—	0.4	0.6	V	$V_{CC} = 5.5\text{V}$, $I_F = 5\text{mA}$, $I_{OL} (\text{sinking}) = 13\text{mA}$	5	
Logic high output current	I_{OH}	—	3	100	μA	$V_{CC} = 5.5\text{V}$, $V_O = 5.5\text{V}$, $I_F = 250\mu\text{A}$	3	
Logic low supply current	I_{CCL}	—	8	13	mA	$V_{CC} = 5.5\text{V}$, $I_F = 10\text{mA}$		1
Logic high supply current	I_{CCH}	—	6	10	mA	$V_{CC} = 5.5\text{V}$, $I_F = 0\text{mA}$		1

Specified over recommended temperature ($T_A = -40^\circ\text{C}$ to $+85^\circ\text{C}$, $4.5\text{V} \leq V_{CC} \leq 5.5\text{V}$), $I_F = 7.5\text{mA}$ unless otherwise specified. All typicals at $T_A = 25^\circ\text{C}$, $V_{CC} = 5.0\text{V}$.

Photocoupler LTV-M601 series

5. SWITCHING SPECIFICATION

Parameter	Symb	Min.	Typ.	Max.	Unit	Test Condition	Fig.	Note
Propagation Delay Time to High Output Level	t_{PLH}	—	60	90	ns	$R_L=350\Omega, C_L=15pF$	1,9	3
Propagation Delay Time to Low Output Level	t_{PHL}	—	25	75			1,9	4
Pulse Width Distortion	$ t_{PLH} - t_{PHL} $	—	35	45			10	—
Propagation Delay Skew	t_{PSK}	—	—	40			—	—
Output Rise Time (10 to 90%)	t_r	—	27	—			—	—
Output Fall Time (90 to 10%)	t_f	—	7	—			—	—

Specified over recommended temperature ($T_A = -40^\circ\text{C}$ to $+85^\circ\text{C}$, $2.7\text{V} \leq V_{CC} \leq 3.6\text{V}$), $I_F = 7.5\text{mA}$ unless otherwise specified. All typicals at $T_A = 25^\circ\text{C}$, $V_{CC} = 3.3\text{V}$.

Parameter	Symbol	Min.	Typ.	Max.	Unit	Test Condition	Not	Fig.
Propagation Delay Time to High Output Level	t_{PLH}	—	45	75	ns	$T_A = 25^\circ\text{C}$ $R_L=350\Omega,$ $C_L = 15pF$	1,9	3
		—	—	100				
Propagation Delay Time to Low Output Level	t_{PHL}	—	25	75		$T_A = 25^\circ\text{C}$ $R_L=350\Omega,$ $C_L = 15pF$	1,9	4
		—	—	100				
Pulse Width Distortion	$ t_{PLH} - t_{PHL} $	—	10	35		$R_L = 350\Omega, C_L = 15pF$	10	—
Propagation Delay Skew	t_{PSK}	—	—	40			—	—
Output Rise Time (10 to 90%)	t_r	—	21	—	—		—	
Output Fall Time (90 to 10%)	t_f	—	7	—	—		—	

Specified over recommended temperature ($T_A = -40^\circ\text{C}$ to $+85^\circ\text{C}$, $4.5\text{V} \leq V_{CC} \leq 5.5\text{V}$), $I_F = 7.5\text{mA}$ unless otherwise specified. All typicals at $T_A = 25^\circ\text{C}$, $V_{CC} = 5.0\text{V}$.

Photocoupler LTV-M601 series

Parameter	Test Condition	Sym.	Min.	Typ.	Max.	Units	Fig.	Note
Common Mode Transient Immunity at High Output Level	$V_{CC} = 3.3V$ $V_{CM} = 1000V$ $R_L = 350\Omega$ $I_F = 0mA$ $T_A = 25^\circ C$	CM _H	10	—	—	KV/ μs	2	5
	$V_{CC} = 5V$ $V_{CM} = 1000V$ $R_L = 350\Omega$ $I_F = 0mA$ $T_A = 25^\circ C$		10	—	—			
Common Mode Transient Immunity at Low Output Level	$V_{CC} = 3.3V$ $V_{CM} = 1000V$ $R_L = 350\Omega$ $I_F = 10.0mA$ $T_A = 25^\circ C$	CM _L	10	—	—	KV/ μs	2	6
	$V_{CC} = 5V$ $V_{CM} = 1000V$ $R_L = 350\Omega$ $I_F = 10.0mA$ $T_A = 25^\circ C$		10	—	—			

Photocoupler LTV-M601 series

6. ISOLATION CHARACTERISTIC

Parameter	Symbol	Min.	Typ.	Max.	Unit	Test Condition	Note
Input-Output Insulation Leakage Current	I_{I-O}	—	—	1.0	μA	45% RH, $t = 5s$, $V_{I-O} = 3kV$ DC, $T_A = 25^\circ C$	7
Withstand Insulation Test Voltage	V_{ISO}	3750	—	—	V_{RMS}	RH $\leq 50\%$, $t = 1min$, $T_A = 25^\circ C$	7, 8
Input-Output Resistance	R_{I-O}	—	10^{12}	—	Ω	$V_{I-O} = 500V$ DC	7
Input-Output Capacitance	C_{I-O}	—	1.0	—	p	$f = 1MHz$, $T_A = 25^\circ C$	7

Specified over recommended temperature ($T_A = -40^\circ C$ to $+85^\circ C$) unless otherwise specified. Typical values applies to $T_A = 25^\circ C$

Note

1. A 0.1 μF or bigger bypass capacitor for V_{CC} is needed as shown in Fig.1
2. Peaking driving circuit may be used to speed up the LED. The peak drive current of LED may go up to 50mA and maximum pulse width 50ns, as long as average current doesn't exceed 20mA.
3. t_{PLH} (propagation delay) is measured from the 3.75 mA point on the falling edge of the input pulse to the 1.5 V point on the rising edge of the output pulse.
4. t_{PHL} (propagation delay) is measured from the 3.75 mA point on the rising edge of the input pulse to the 1.5 V point on the falling edge of the output pulse.
5. CM_H is the maximum tolerable rate of rise of the common mode voltage to assure that the output will remain in a high logic state (i.e., $V_O > 2.0 V$).
6. CM_L is the maximum tolerable rate of fall of the common mode voltage to assure that the output will remain in a low logic state (i.e., $V_O < 0.8 V$).
7. Device is considered a two-terminal device: pins 1, 3 shorted together, and pins 4, 5, 6 shorted together.
8. In accordance with UL1577, each optocoupler is proof tested by applying an insulation test voltage 4500 Vrms for one second (leakage current less than 10 μA). This test is performed before the 100% production test for partial discharge

Photocoupler
LTV-M601 series

7. SWITCHING TIME TEST CIRCUIT

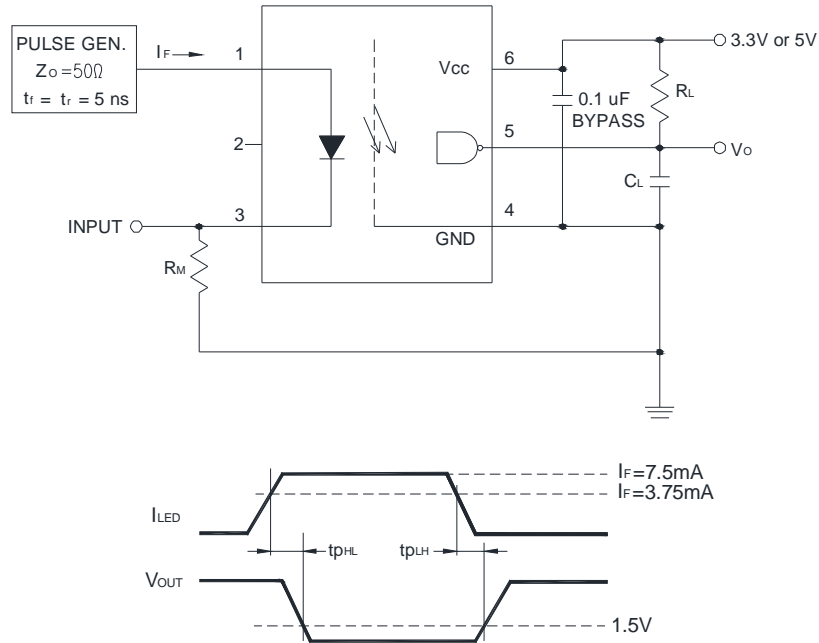

Figure 1: Test Circuit for t_{PHL} and t_{PLH}

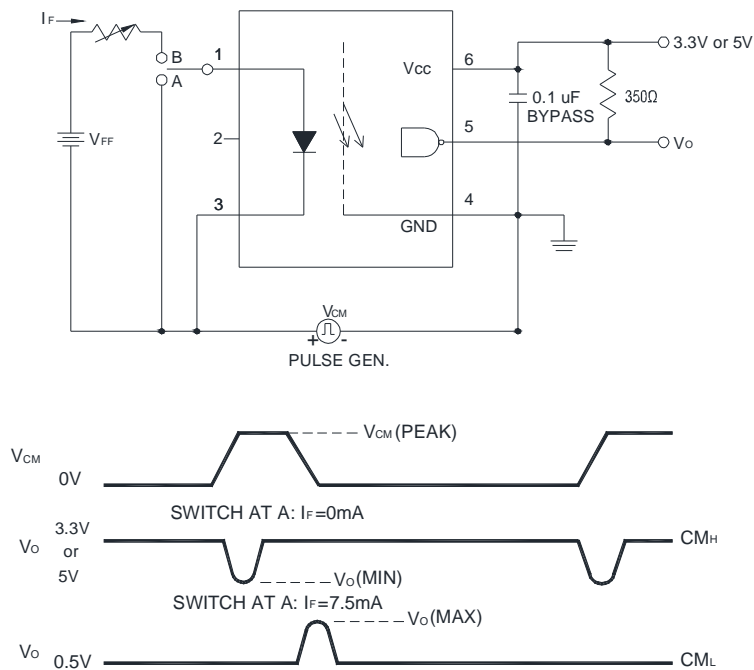

Figure 2: Test Circuit for Common Mode Transient Immunity

Photocoupler LTV-M601 series

8. TYPICAL PERFORMANCE CURVES

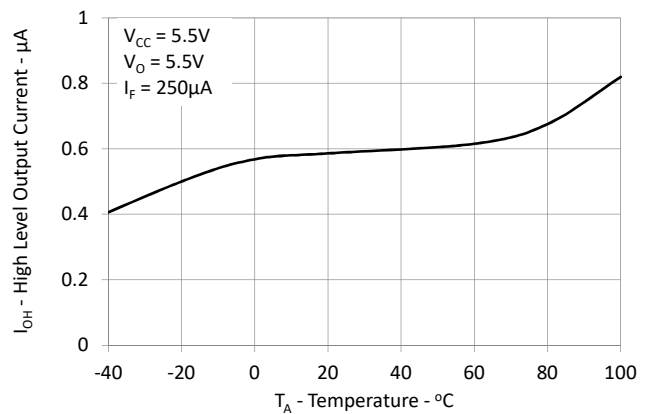
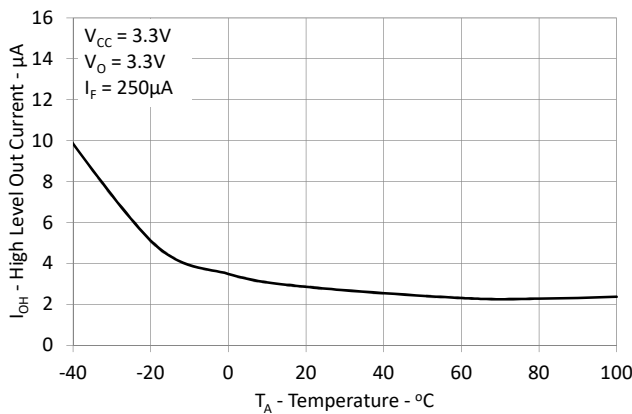

Figure 3: Typical high level output current vs. temperature.

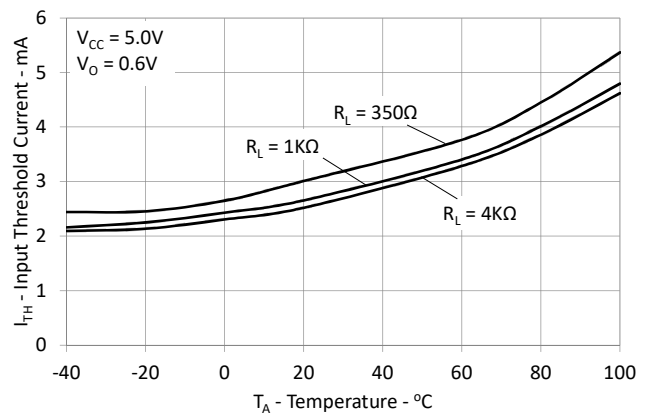
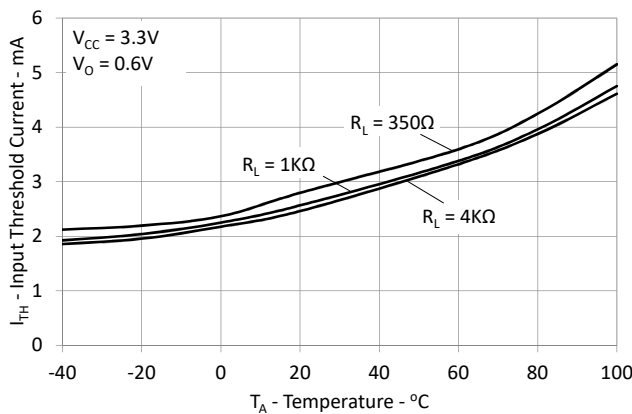

Figure 4: Typical Input Diode Threshold Current vs. Ambient Temperature

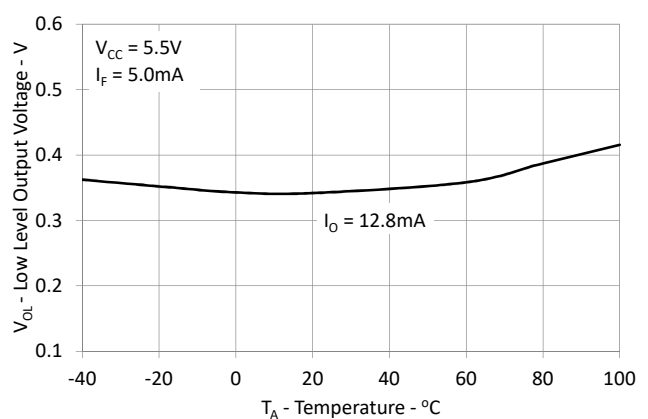
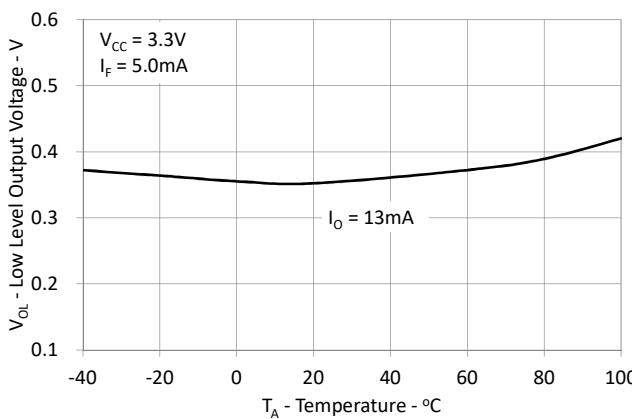

Figure 5: Typical Low Level Output Voltage vs. Ambient Temperature

**Photocoupler
LTV-M601 series**

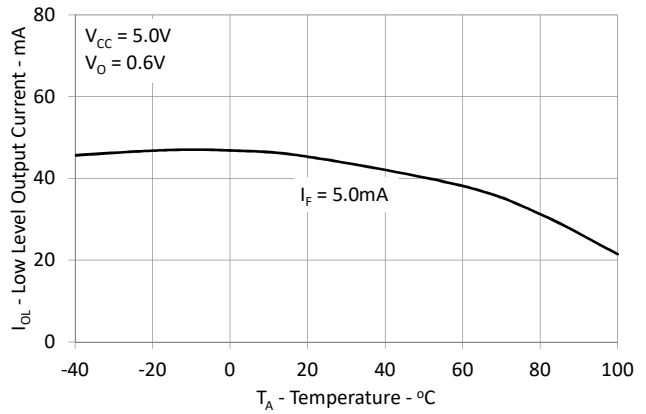
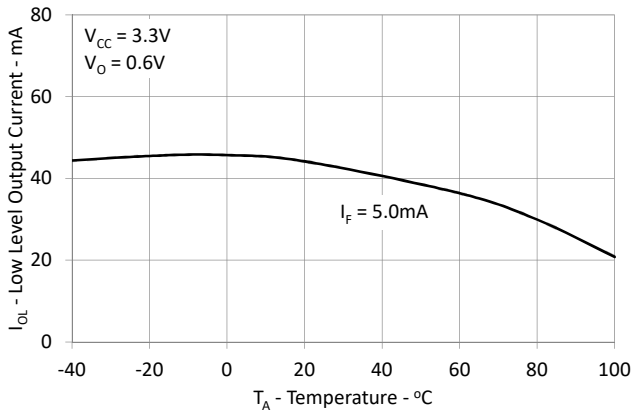

Figure 6: Typical Low Level Output Current vs. Ambient Temperature

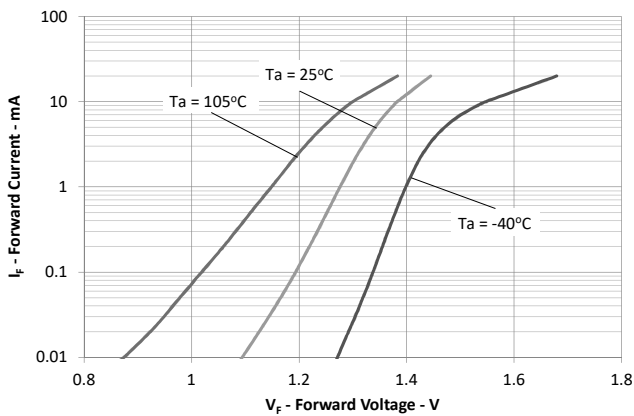

Figure 7: Typical Input Diode Forward Characteristics

Photocoupler LTV-M601 series

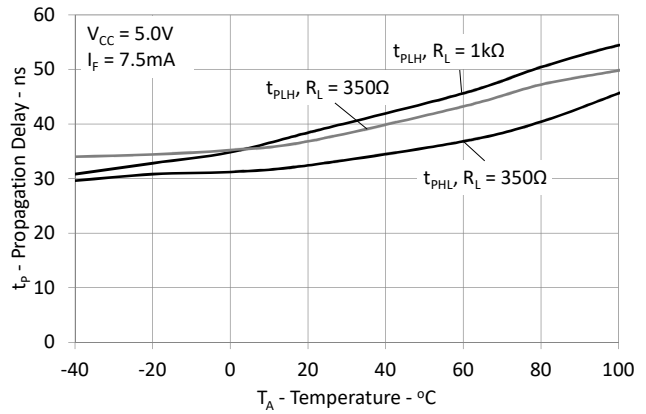
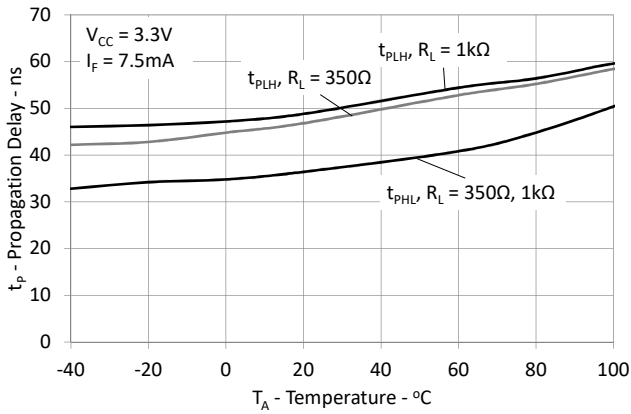

Figure 8: Typical Propagation Delay vs. Ambient Temperature

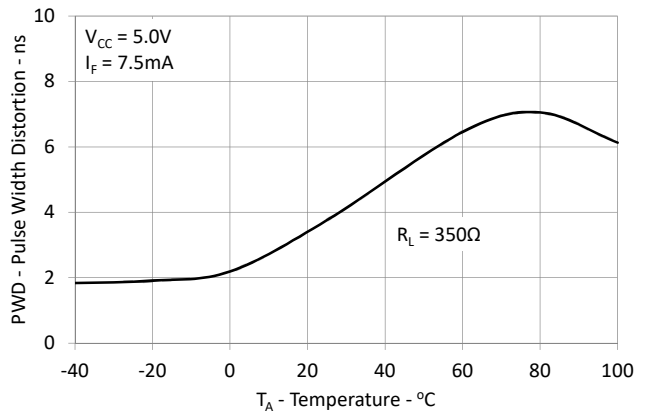
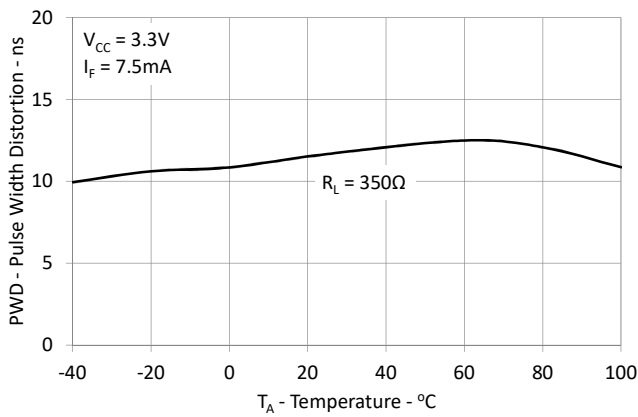

Figure 9: Typical Pulse Width Distortion vs. Ambient Temperature

Photocoupler LTV-M601 series

9. TEMPERATURE PROFILE OF SOLDERING

9.1 IR Reflow soldering (JEDEC-STD-020C compliant)

One time soldering reflow is recommended within the condition of temperature and time profile shown below. Do not solder more than three times.

Profile item	Conditions
Preheat	
- Temperature Min (T_{Smin})	150°C
- Temperature Max (T_{Smax})	200°C
- Time (min to max) (ts)	90±30 sec
Soldering zone	
- Temperature (T_L)	217°C
- Time (t_L)	60 ~ 100sec
Peak Temperature (T_P)	260°C
Ramp-up rate	3°C / sec max.
Ramp-down rate	3~6°C / sec

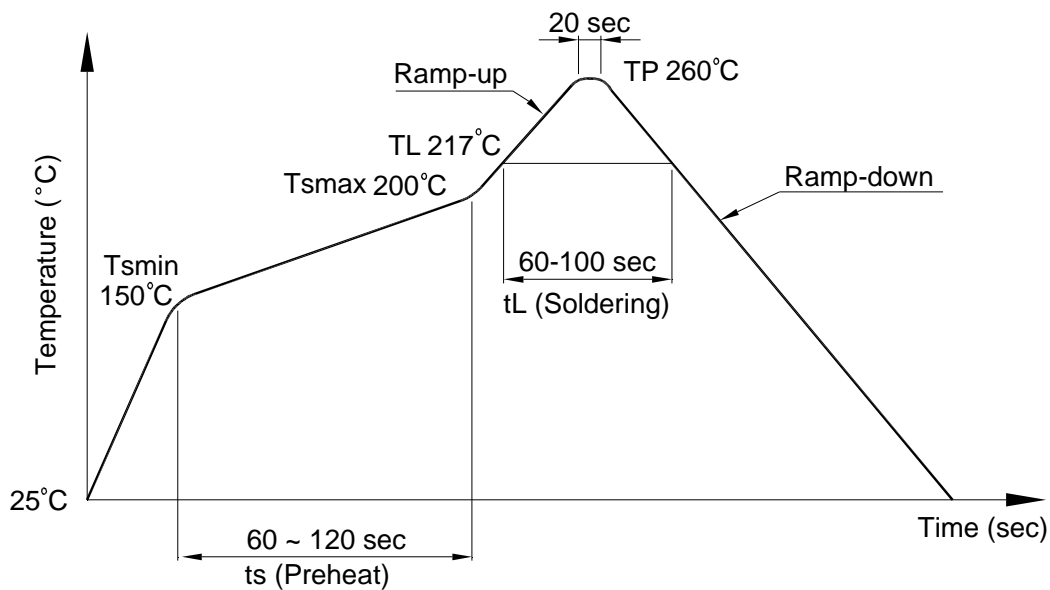

**Photocoupler
LTV-M601 series**

9.2 Wave soldering (JEDEC22A111 compliant)

One time soldering is recommended within the condition of temperature.

Temperature: $260 \pm 0 / -5^{\circ}\text{C}$

Time: 10 sec.

Preheat temperature: 25 to 140°C

Preheat time: 30 to 80 sec.

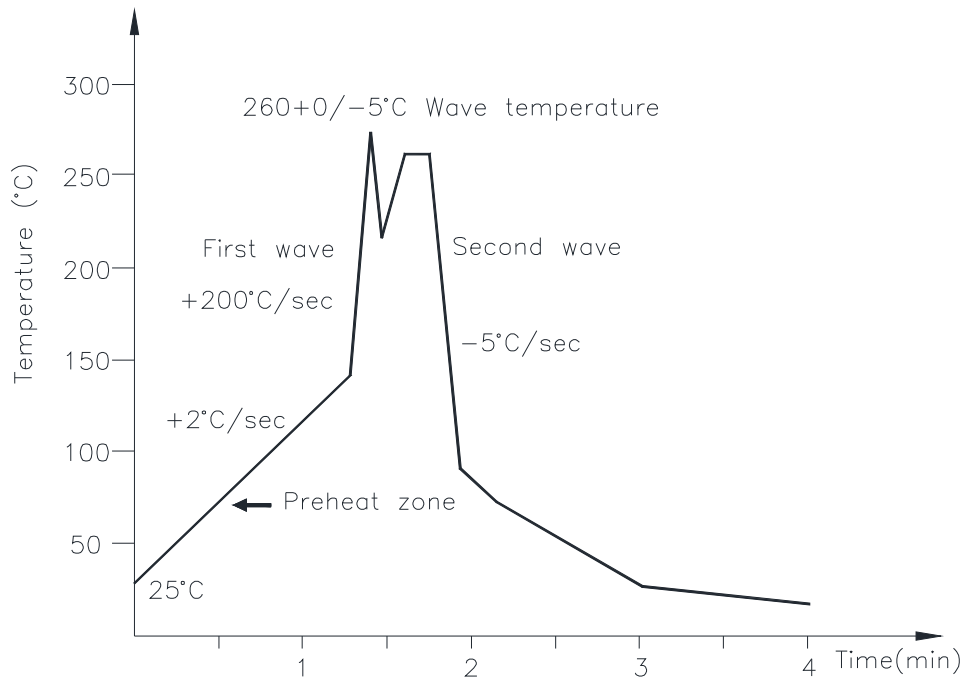

9.3 Hand soldering by soldering iron

Allow single lead soldering in every single process. One time soldering is recommended.

Temperature: $380 \pm 0 / -5^{\circ}\text{C}$

Time: 3 sec max.

**Photocoupler
LTV-M601 series**

10. NAMING RULE

Part Number Options	
LTV-M601-TP	
LTV-M601	
LTV-M601-G	
LTV-M601-TP-G	
LTVM601TP-V	
LTVM601-V	
LTVM601TP-V-G	
LTVM601-V-G	
Definition of Suffix	Remark
"M601"	LiteOn model name
" no suffix "	Pin 1 location at upper right of the tape
"G"	Halogen free
"TP"	Pin 1 location at lower left of the tape
"V"	VDE approved option

11. NOTES

LiteOn is continually improving the quality, reliability, function or design and LiteOn reserves the right to make changes without further notices.

The products shown in this publication are designed for the general use in electronic applications such as office automation equipment, communications devices, audio/visual equipment, electrical application and instrumentation.

For equipment/devices where high reliability or safety is required, such as space applications, nuclear power control equipment, medical equipment, etc, please contact our sales representatives.

When requiring a device for any "specific" application, please contact our sales in advice.

If there are any questions about the contents of this publication, please contact us at your convenience.

The contents described herein are subject to change without prior notice.

Immerge unit's body in solder paste is not recommended.