

FEATURES

- Inherently Matched LED Current
- Drives Up to 27 LEDs from a 5V Supply
- Power Management IC
- 36V Rugged Bipolar Switch
- Fast 1.2MHz Switching Frequency
- $V_{ovp(MAX)} = 29V$
- Moisture Sensitivity Level 3

APPLICATION

- Cellular Phones
- PDAs, Handheld Computers
- Digital Cameras
- MP3 Players
- GPS Receivers

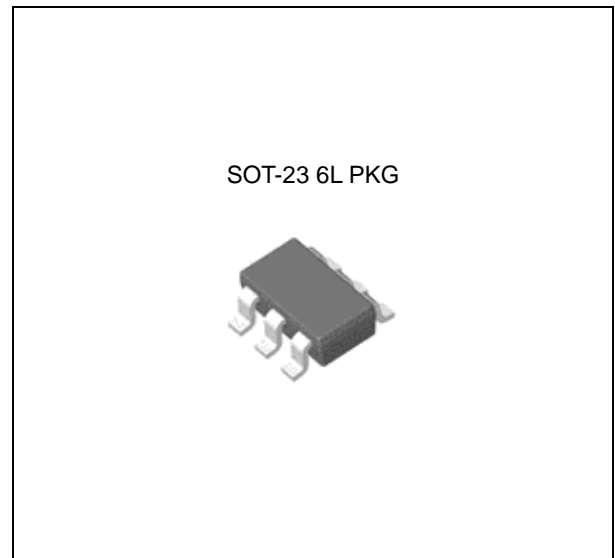

ORDERING INFORMATION

Device	Package
LM1938SFG6	SOT-23 6L

DESCRIPTION

The LM1938 is a step-up DC/DC converter specifically designed to drive white LEDs with a constant current. The device can drive up to 27 LEDs from a 5V supply.

Additional features include output voltage limiting when LEDs are disconnected.

Absolute Maximum Ratings (Note 1)

CHARACTERISTIC	SYMBOL	RATINGS	UNIT
Input Voltage	V_{IN}	10	V
SW Voltage	V_{SW}	36	V
FB Voltage	V_{FB}	10	V
\overline{SHDN} Voltage	$V_{\overline{SHDN}}$	10	V
Lead Temperature (Soldering, 10 sec)	T_{SOL}	300	°C
Storage Temperature Range	T_{STG}	-65 ~ 150	°C
Operating Temperature Range	T_{OPR}	-40 ~ 85	°C
Maximum Junction Temperature	$T_{J(max)}$	125	°C

Note 1. Absolute Maximum Ratings are those values beyond which the life of the device may be impaired.

Ordering Information

Package	Order No.	Package Marking	Supplied As	Status
SOT-23 6L	LM1938SF6	LM1938	Reel	Active

PIN CONFIGURATION

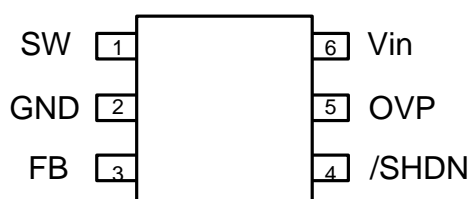

PIN DESCRIPTION

SOT-23-6L		
Pin No.	Name	Function
1	SW	Switching Pin. This is the collector of the internal NPN power switch. Connect to inductor and diode. Minimize the metal trace area connected to this pin to reduce EMI.
2	GND	Ground Pin. Connect directly to local ground plane.
3	FB	Feedback Pin. Reference voltage is 95mV. Connect LEDs and a resistor at this pin.
4	$\overline{\text{SHDN}}$	Shutdown Pin. Connect to 1.5V or higher to enable device; 0.4V or less to disable device.
5	OVP	Over voltage protection, 29.
6	Vin	Input Supply Pin. Bypass this pin with a capacitor as close to the device as possible.

BLOCK DIAGRAM

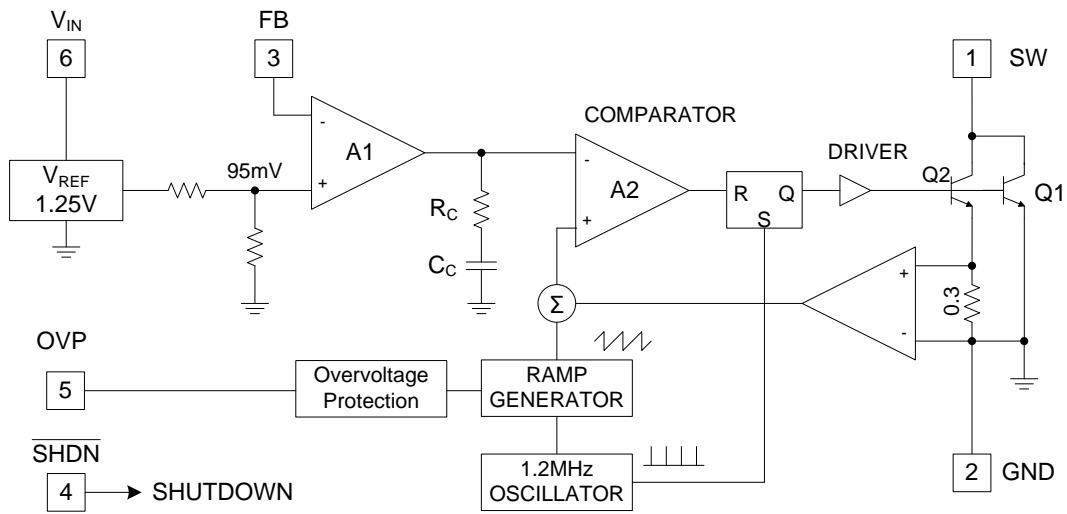

Fig. 1 Block Diagram

TYPICAL APPLICATION

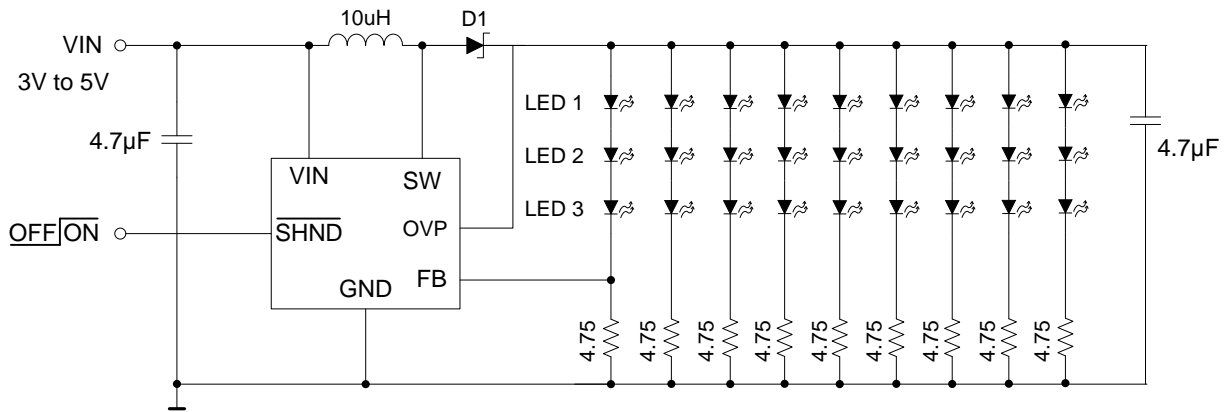
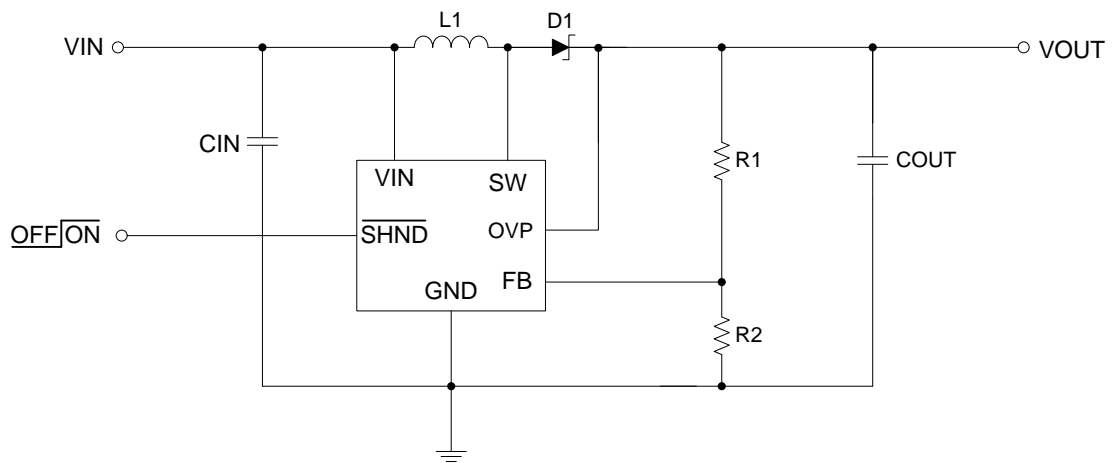

Fig. 2 Li-Ion Powered Driver for 27 White LEDs



$$V_{OUT} = V_{FB} \times \left(1.0 + \frac{R_1}{R_2}\right), \text{ Where } V_{FB}=95\text{mV}$$

Fig. 3 Powered Driver for Step-up converter

ELECTRICAL CHARACTERISTICS

$T_A = 25^\circ\text{C}$, $V_{IN} = 5\text{V}$, $V_{\overline{\text{SHDN}}} = 5\text{V}$, unless otherwise noted.

PARAMETER	SYMBOL	TEST CONDITION	MIN.	TYP.	MAX.	UNIT
Minimum Operating Voltage	V_{INMIN}		2.5			V
Maximum Operating Voltage	V_{INMAX}				10	V
Feedback Voltage	V_{FB}	$I_{LOAD} = 180\text{mA}$, $V_{IN}=5\text{V}$	86	95	104	mV
FB Pin Bias Current			10	45	100	nA
Supply Current		$/\overline{\text{SHDN}} = 0\text{V}$		2.1 0.1	3.0 1.0	mA uA
Switching Frequency			1.1	1.3	1.6	MHz
Maximum Duty Cycle			85	90		%
Switch Current Limit				650		mA
Switch V_{CESAT}		$I_{SW} = 250\text{mA}$		350		mV
Switch Leakage Current		$V_{SW} = 5\text{V}$		0.01	5	uA
$\overline{\text{SHDN}}$ Voltage High			1.5			V
$\overline{\text{SHDN}}$ Voltage Low					0.4	V
$\overline{\text{SHDN}}$ Pin Bias Current				65		uA
OVP Threshold				29		V

OPERATION

The LM1938 uses a constant frequency, current mode control scheme to provide excellent line and load regulation. Operation can be best understood by referring to the Block Diagram in figure 2. At the start of each oscillator cycle, the RS latch is set, which turns on the power switch Q1. A voltage proportional to the switch current is added to a stabilizing ramp and the resulting sum is fed into the positive terminal of the PWM comparator A2. When this voltage exceeds the level at the negative input of A2, the RS latch is reset turning off the power switch. The level at the negative input of A2 is set by the error amplifier A1, and is simply an amplified version of the difference between the feedback voltage and the reference voltage of 95mV. In this manner, the error amplifier sets the correct peak current level to keep the output in regulation. If the error amplifier's output increases, more current is delivered to the output; if it decreases, less current is delivered.

TYPICAL OPERATING CHARACTERISTICS

Output Voltage vs Input Voltage (V_{OUT}=10V)

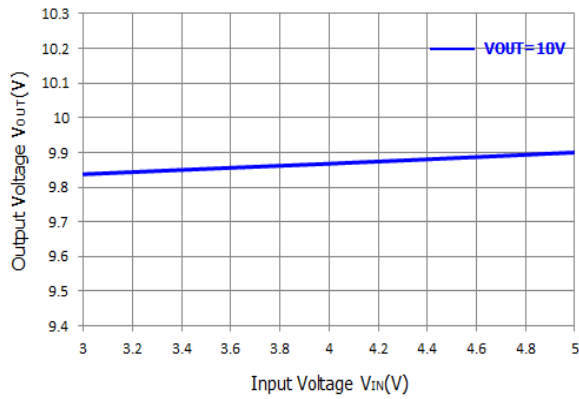

Output Voltage vs Input Voltage (V_{OUT}=15V)

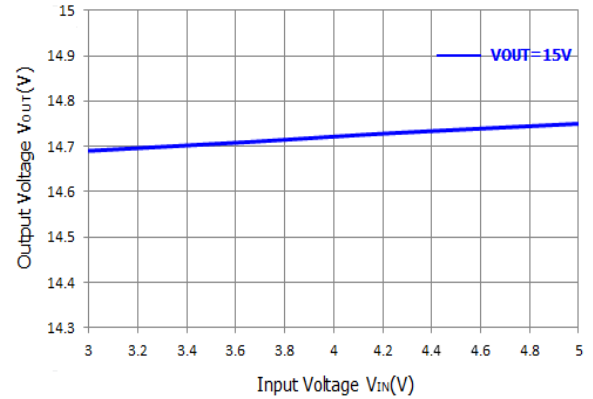

Output Voltage vs Input Voltage (V_{OUT}=20V)

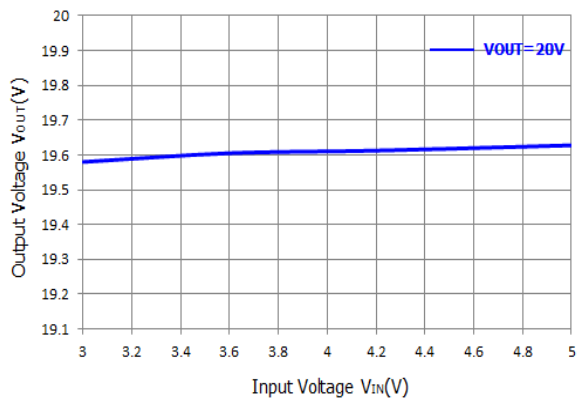

Output Voltage vs Output Current (V_{IN}=3.0V)

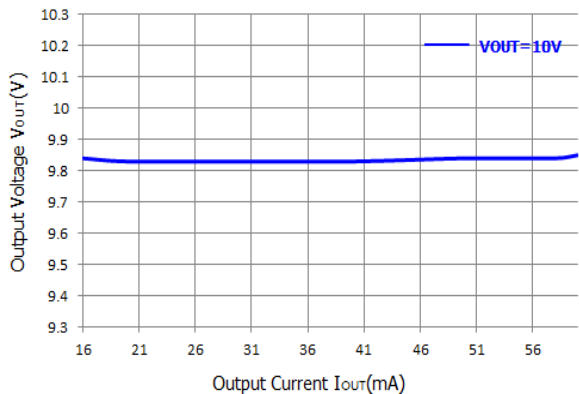

Output Voltage vs Output Current (V_{IN}=3.6V)

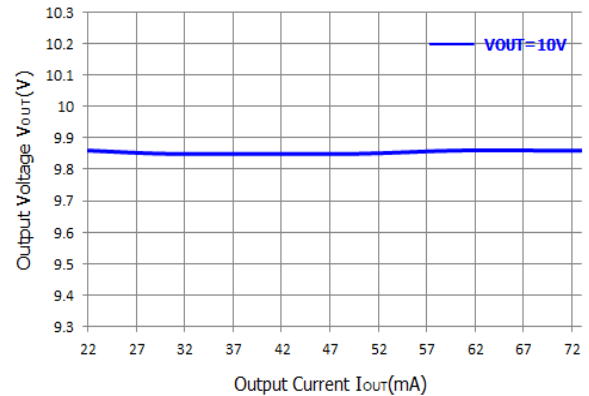

TYPICAL OPERATING CHARACTERISTICS (Continued)

Output Voltage vs Output Current (VIN=4.2V)

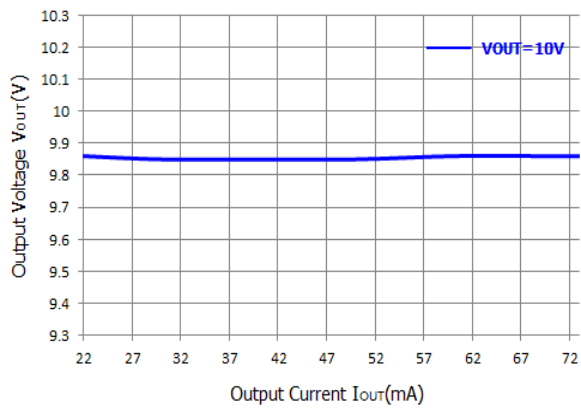

Output Voltage vs Output Current (VIN=5.0V)

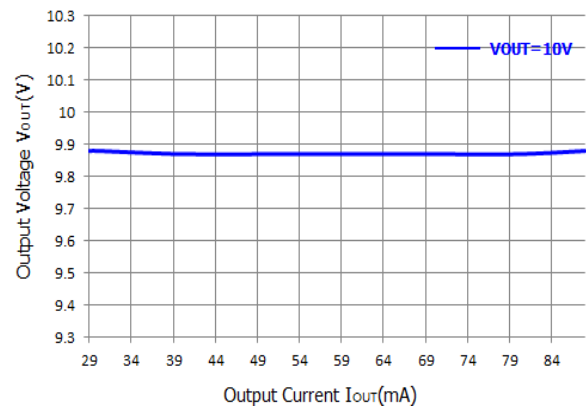

Output Voltage vs Output Current (VIN=3.0V)

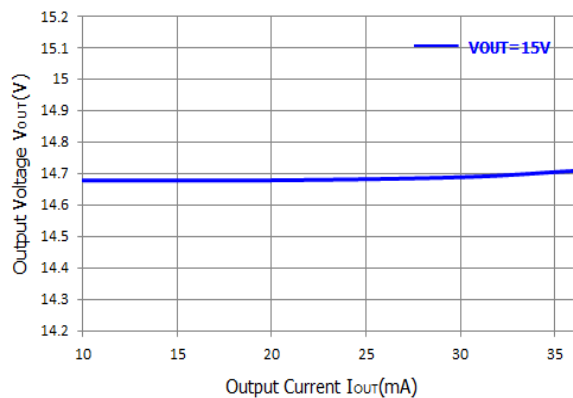

Output Voltage vs Output Current (VIN=3.6V)

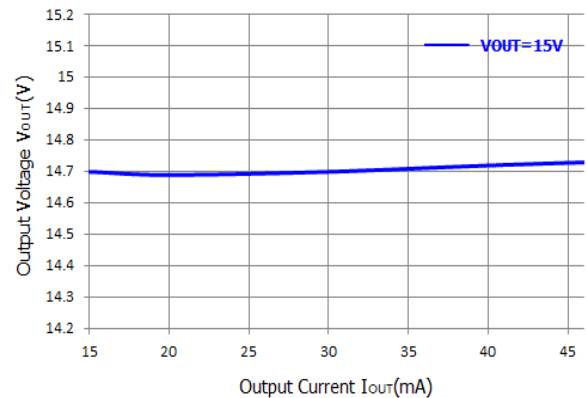

Output Voltage vs Output Current (VIN=4.2V)

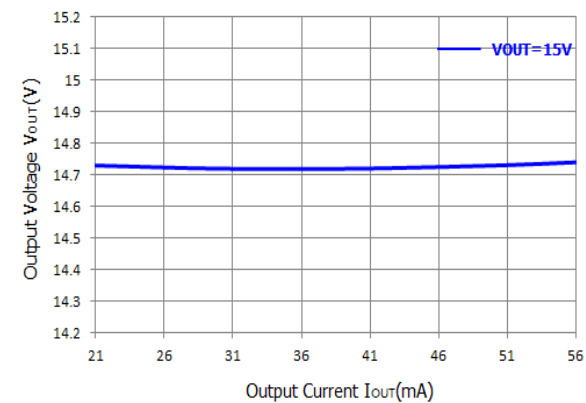

Output Voltage vs Output Current (VIN=5.0V)

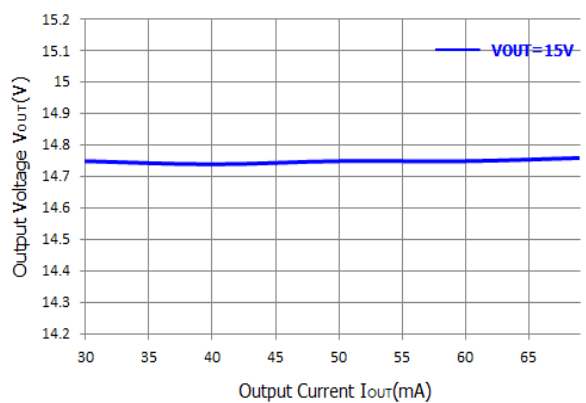

TYPICAL OPERATING CHARACTERISTICS (Continued)

Output Voltage vs Output Current (VIN=3.0V)

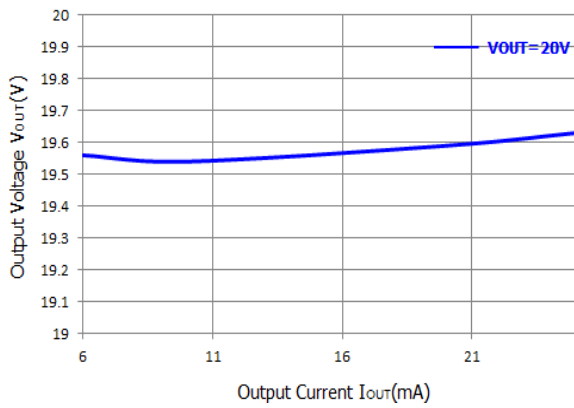

Output Voltage vs Output Current (VIN=3.6V)

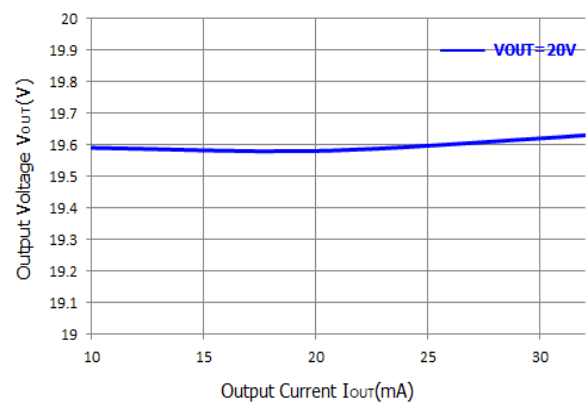

Output Voltage vs Output Current (VIN=4.2V)

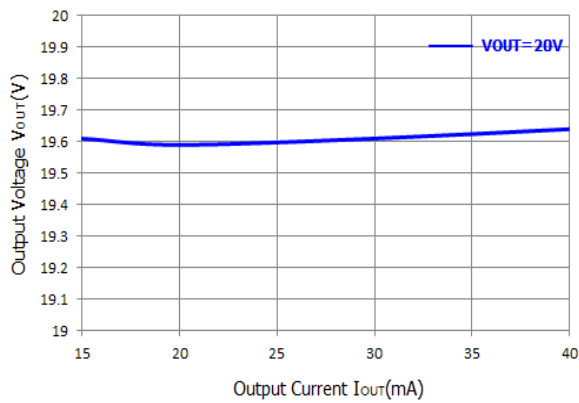

Output Voltage vs Output Current (VIN=5.0V)

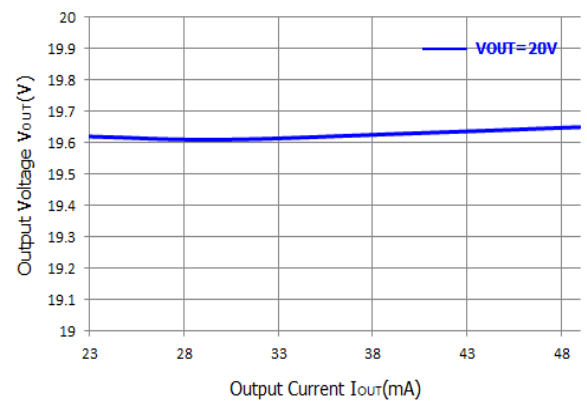

Efficiency vs Output Current (VOUT=10V)

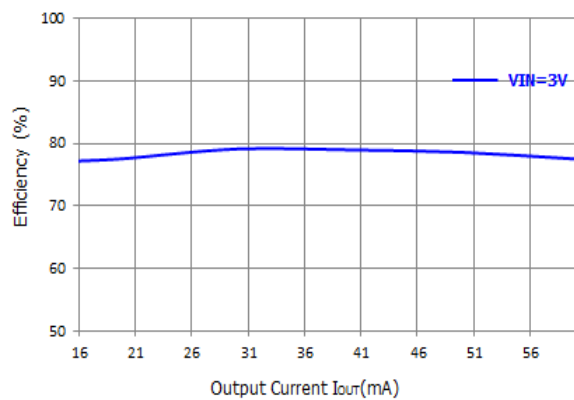

Efficiency vs Output Current (VOUT=10V)

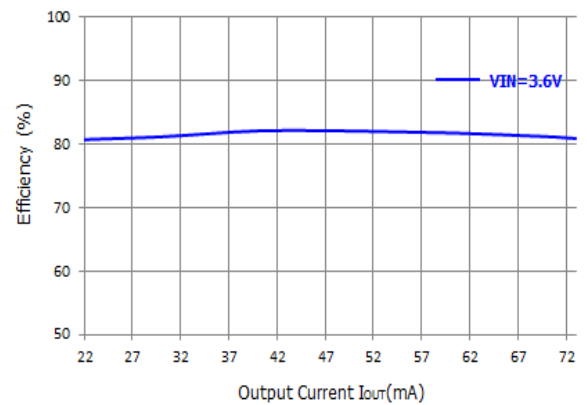

TYPICAL OPERATING CHARACTERISTICS (Continued)

Efficiency vs Output Current (V_{OUT}=10V)

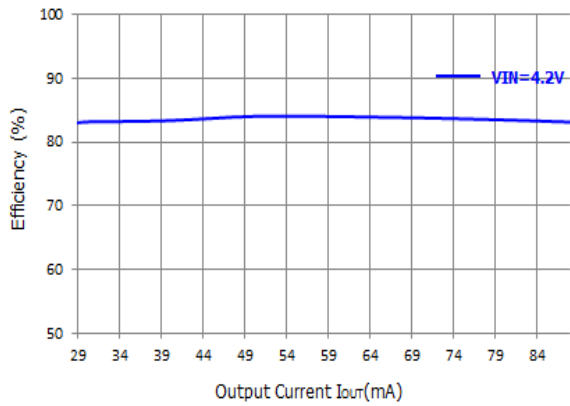

Efficiency vs Output Current (V_{OUT}=10V)

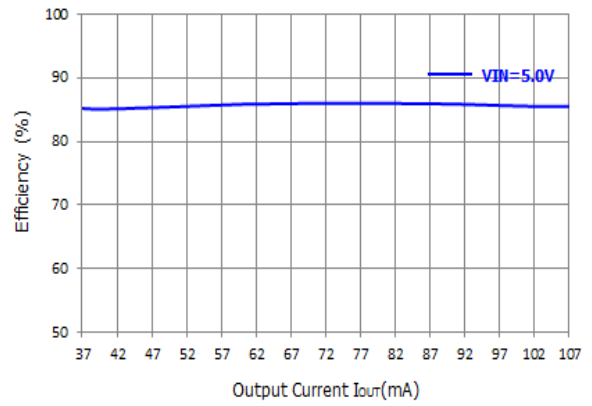

Efficiency vs Output Current (V_{OUT}=15V)

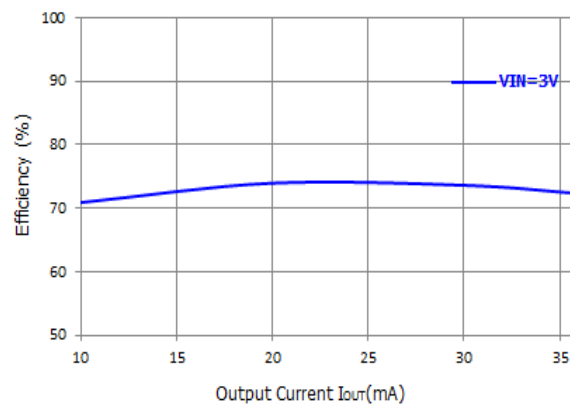

Efficiency vs Output Current (V_{OUT}=15V)

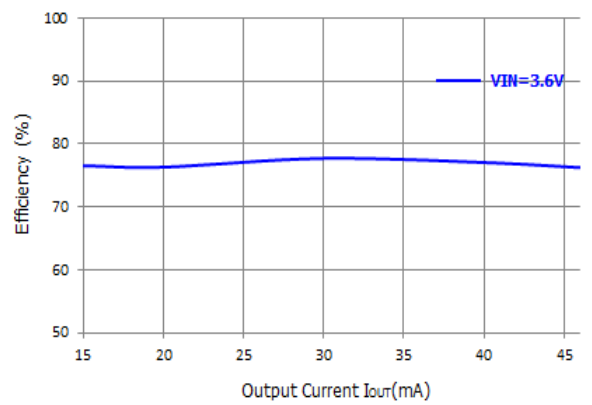

Efficiency vs Output Current (V_{OUT}=15V)

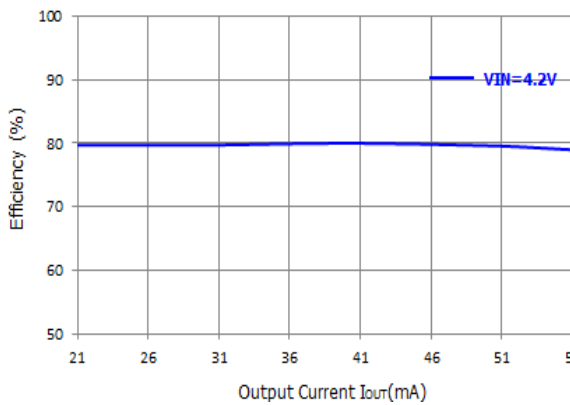

Efficiency vs Output Current (V_{OUT}=15V)

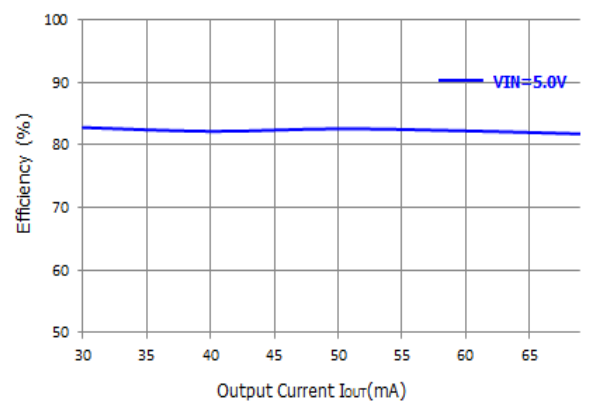

TYPICAL OPERATING CHARACTERISTICS (Continued)

Efficiency vs Output Current (VOUT=20V)

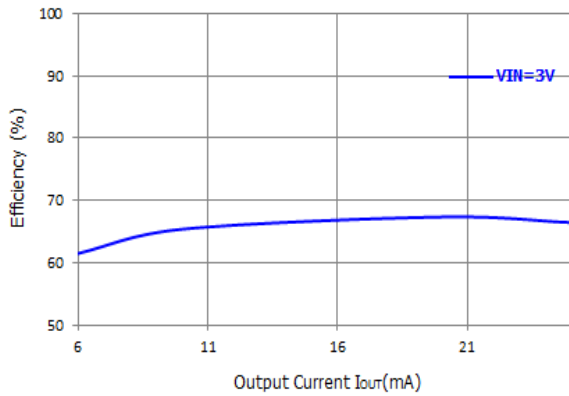

Efficiency vs Output Current (VOUT=20V)

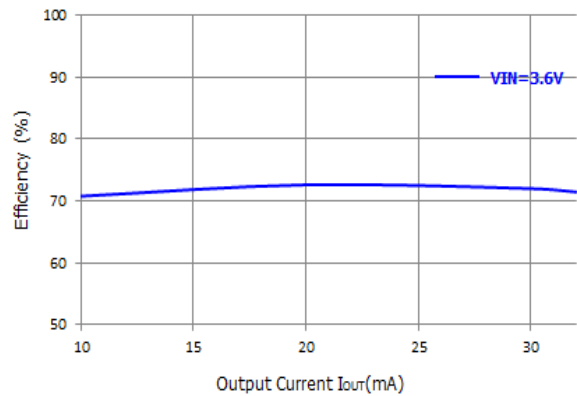

Efficiency vs Output Current (VOUT=20V)

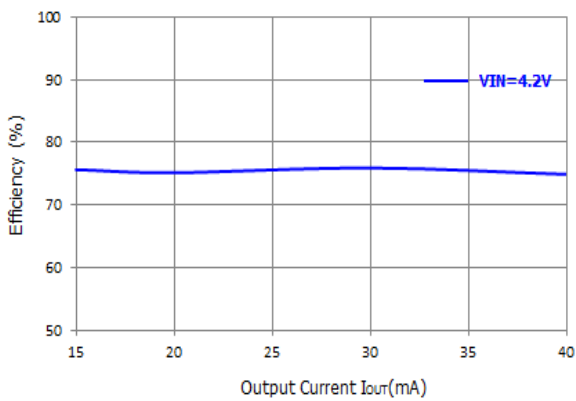

Efficiency vs Output Current (VOUT=20V)

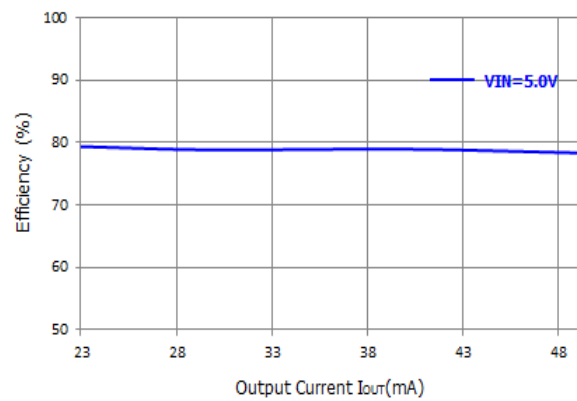

Output voltage vs Temperature (VOUT=10V)

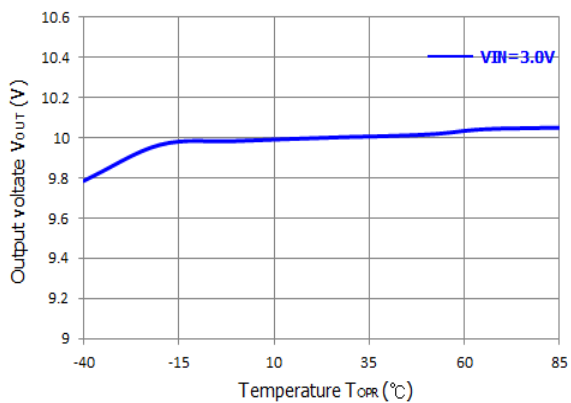

Output voltage vs Temperature (VOUT=15V)

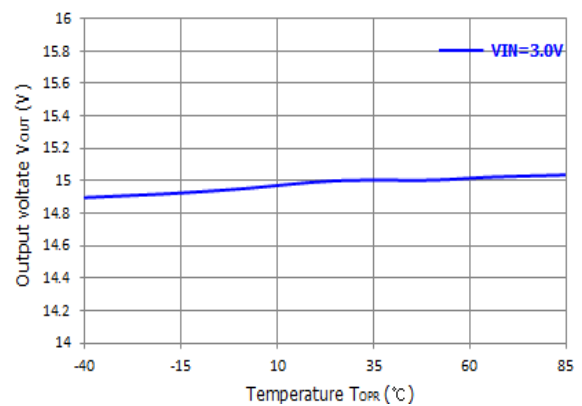

TYPICAL OPERATING CHARACTERISTICS (Continued)

Output voltage vs Temperature (V_{OUT}=20V)

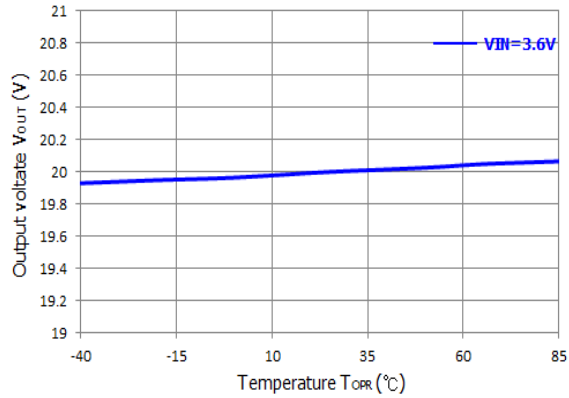

Reference voltage vs Temperature (V_{OUT}=10V)

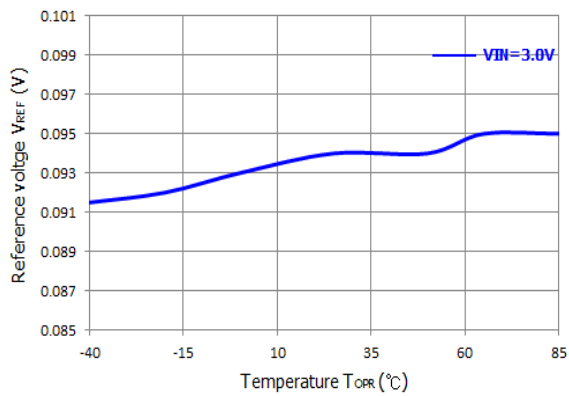

Reference voltage vs Temperature (V_{OUT}=15V)

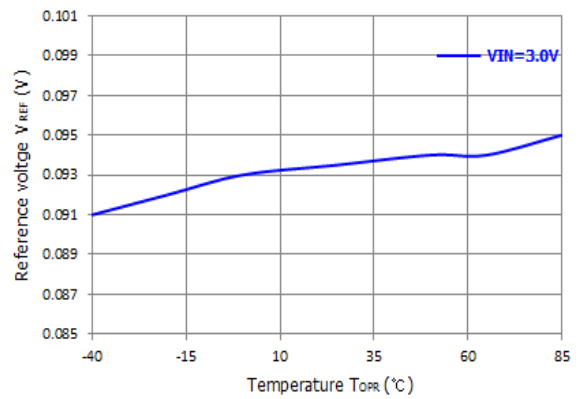

Reference voltage vs Temperature (V_{OUT}=20V)

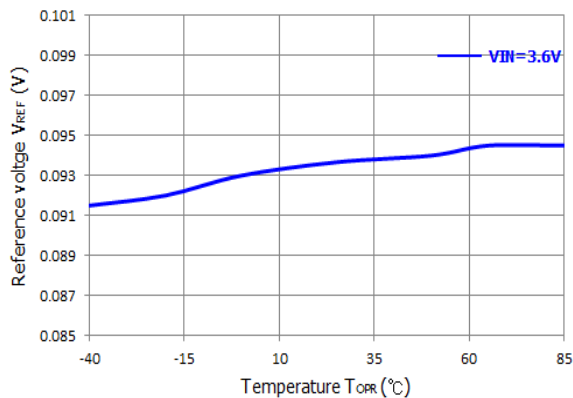

TYPICAL OPERATING CHARACTERISTICS (Continued)

Oscillator Frequency vs Temperature (VOUT=10V)

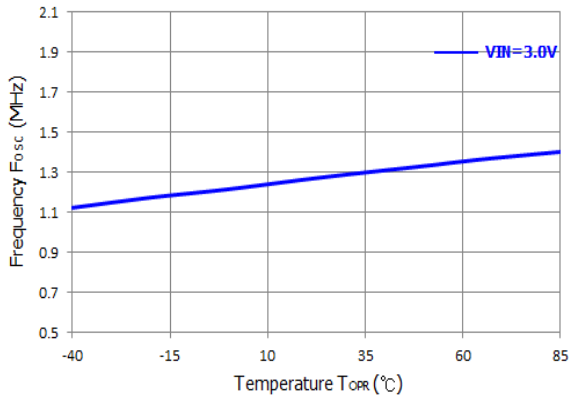

Oscillator Frequency vs Temperature (VOUT=15V)

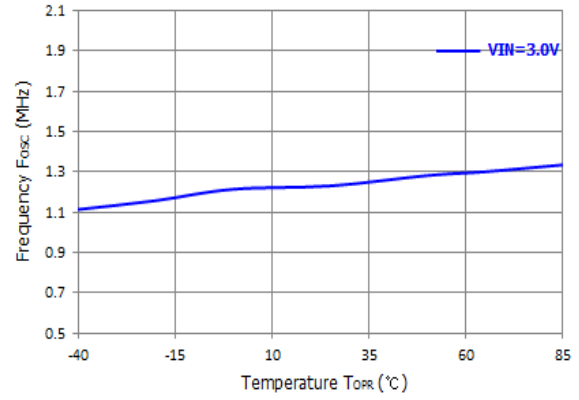

Oscillator Frequency vs Temperature (VOUT=20V)

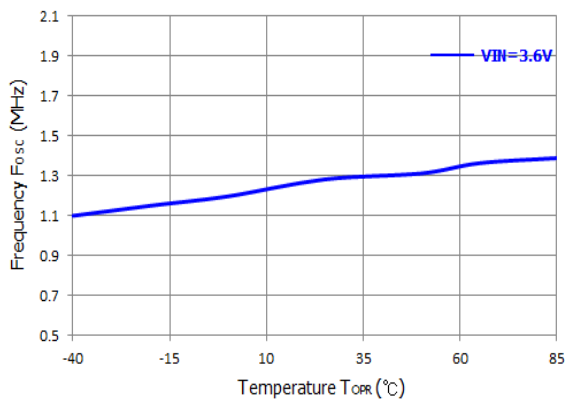

DC/DC Output Waveform (VOUT=10V)

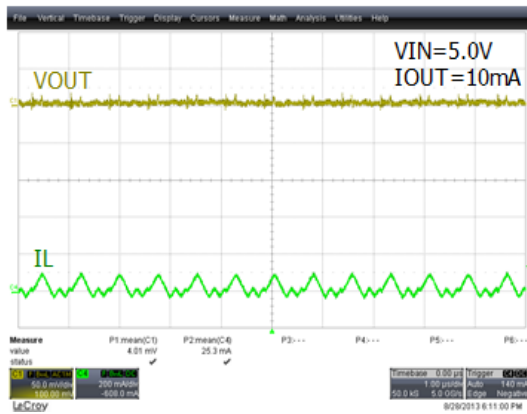

DC/DC Output Waveform (VOUT=15V)

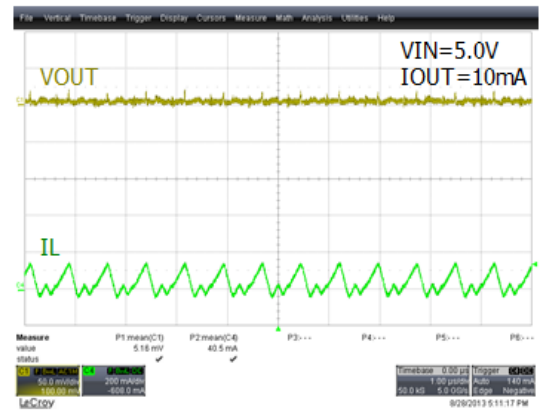

TYPICAL OPERATING CHARACTERISTICS (Continued)

DC/DC Output Waveform (VOUT=20V)

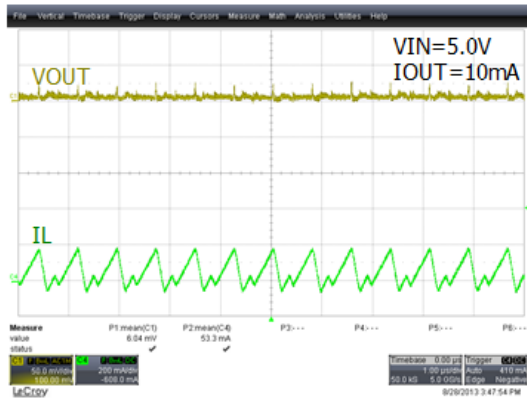

APPLICATION INFORMATION

Inductor Selection

A 10 μ H inductor is recommended for most LM1938 applications. Although small size and high efficiency are major concerns, the inductor should have low core losses at 1.2MHz and low DCR (copper wire resistance).

Capacitor Selection

The small size of ceramic capacitors makes them ideal for LM1938 applications. X5R and X7R types are recommended because they retain their capacitance over wider voltage and temperature ranges than other types such as Y5V or Z5U. A 4,7 μ F input capacitor and a 4,7 μ F output capacitor are sufficient for most LM1938 applications.

Diode Selection

Schottky diodes, with their low forward voltage drop and fast reverse recovery, are the ideal choices for LM1938 applications. The forward voltage drop of a Schottky diode represents the conduction losses in the diode, while the diode capacitance represents the switching losses. For diode selection, both forward voltage drop and diode capacitance need to be considered. Schottky diodes with higher current ratings usually have lower forward voltage drop and larger diode capacitance, which can cause significant switching losses at the 1.2MHz switching frequency of the LM1938. A Schottky diode rated at 1000mA is sufficient for most LM1938 applications.

REVISION NOTICE

The description in this datasheet can be revised without any notice to describe its electrical characteristics properly.