

**ESD5452E**
**2-Lines, Bi-directional, Transient Voltage Suppressors**
<http://www.sh-willsemi.com>
**Descriptions**

The ESD5452E is a bi-directional TVS (Transient Voltage Suppressor). It is specifically designed to protect sensitive electronic components which are connected to low speed data lines and control lines from over-stress caused by ESD (Electrostatic Discharge), EFT (Electrical Fast Transients) and Lightning.

The ESD5452E may be used to provide ESD protection up to  $\pm 30\text{kV}$  (contact and air discharge) according to IEC61000-4-2, and withstand peak pulse current up to 8A (8/20 $\mu\text{s}$ ) according to IEC61000-4-5.

The ESD5452E is available in SOT-23 package. Standard products are Pb-free and Halogen-free.

**Features**

- Reverse stand-off voltage:  $\pm 5\text{V}$  Max
- Transient protection for each line according to IEC61000-4-2 (ESD):  $\pm 30\text{kV}$  (contact and air discharge)  
IEC61000-4-4 (EFT): 40A (5/50ns)  
IEC61000-4-5 (surge): 8A (8/20 $\mu\text{s}$ )
- Capacitance:  $C_J = 17.5\text{pF}$  typ.
- Low leakage current:  $I_R < 1\text{nA}$  typ.
- Low clamping voltage:  $V_{CL} = 9\text{V}$  typ. @  $I_{PP} = 16\text{A}$  (TLP)
- Solid-state silicon technology

**Applications**

- Cellular handsets
- Tablets
- Laptops
- Other portable devices
- Network communication devices

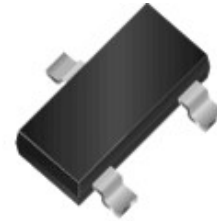
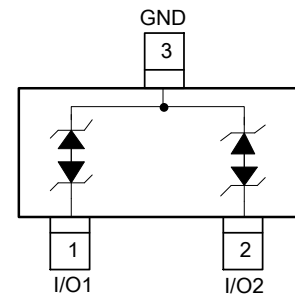
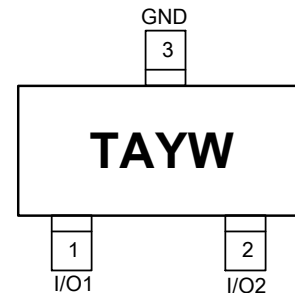
**SOT-23 (Bottom View)**

**Circuit diagram**

TA = Device code

YW = Data code

**Marking (Top View)**
**Order information**

Device	Package	Shipping
ESD5452E-3/TR	SOT-23	3000/Tape&Reel

**Absolute maximum ratings**

Parameter	Symbol	Rating	Unit
Peak pulse power ( $t_p = 8/20\mu s$ )	$P_{pk}$	80	W
Peak pulse current ( $t_p = 8/20\mu s$ )	$I_{PP}$	8	A
ESD according to IEC61000-4-2 air discharge	$V_{ESD}$	$\pm 30$	kV
ESD according to IEC61000-4-2 contact discharge		$\pm 30$	
Operation temperature	$T_{OP}$	-40 to 85	$^{\circ}C$
Storage temperature	$T_{STG}$	-55 to 150	$^{\circ}C$
Lead temperature	$T_L$	260	$^{\circ}C$
Storage temperature	$T_{STG}$	-55~150	$^{\circ}C$

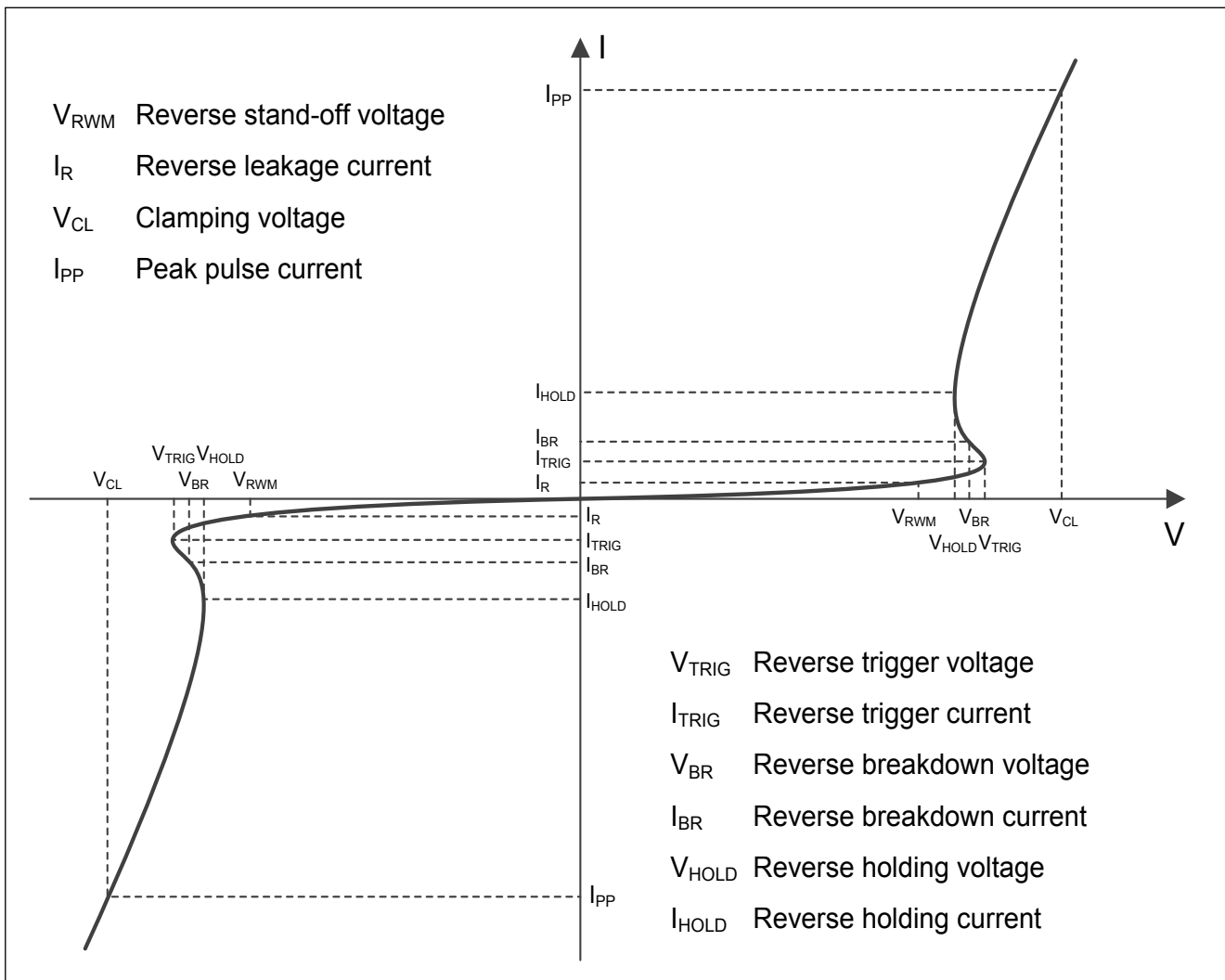
**Electrical characteristics ( $T_A=25^{\circ}C$ , unless otherwise noted)**

**Definitions of electrical characteristics**

**Electrical characteristics (T<sub>A</sub>=25 °C, unless otherwise noted)**

Parameter	Symbol	Condition	Min.	Typ.	Max.	Unit
Reverse stand-off voltage	V <sub>RWM</sub>				±5	V
Reverse leakage current	I <sub>R</sub>	V <sub>RWM</sub> = 5V		<1	100	nA
Reverse breakdown voltage	V <sub>BR</sub>	I <sub>BR</sub> = 1mA	5.1			V
Reverse holding voltage	V <sub>HOLD</sub>	I <sub>HOLD</sub> = 50mA	5.1			V
Clamping voltage <sup>1)</sup>	V <sub>CL</sub>	I <sub>PP</sub> = 16A, t <sub>p</sub> = 100ns		9		V
Clamping voltage <sup>2)</sup>	V <sub>CL</sub>	V <sub>ESD</sub> = 8kV		9		V
Clamping voltage <sup>3)</sup>	V <sub>CL</sub>	I <sub>PP</sub> = 1A, t <sub>p</sub> = 8/20μs			6.5	V
		I <sub>PP</sub> = 5A, t <sub>p</sub> = 8/20μs			8.5	V
		I <sub>PP</sub> = 8A, t <sub>p</sub> = 8/20μs			10	V
Dynamic resistance <sup>1)</sup>	R <sub>DYN</sub>			0.20		Ω
Junction capacitance	C <sub>J</sub>	V <sub>R</sub> = 0V, f = 1MHz		17.5	22	pF
		V <sub>R</sub> = 5V, f = 1MHz		11.5	16	pF

**Notes:**

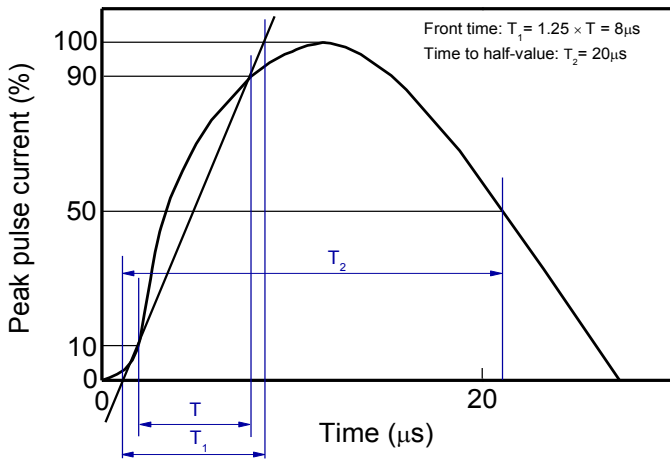
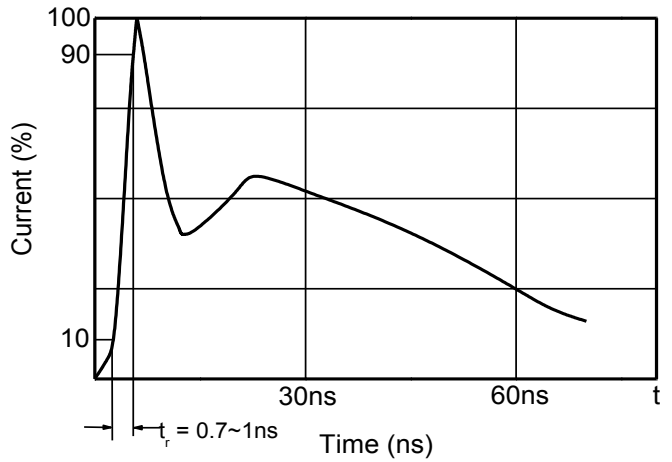
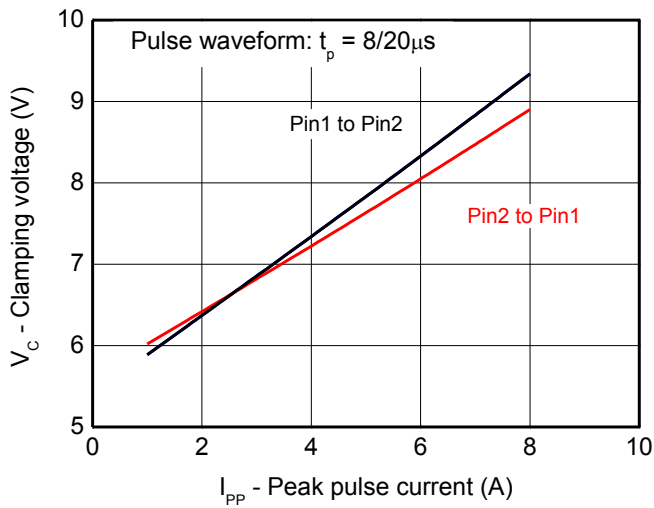
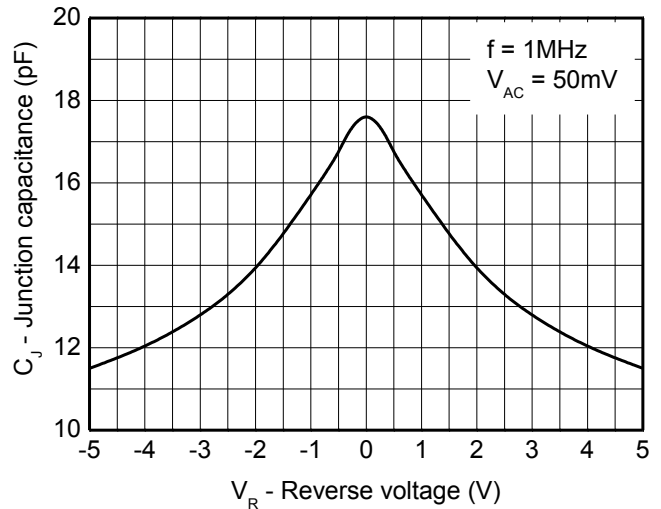
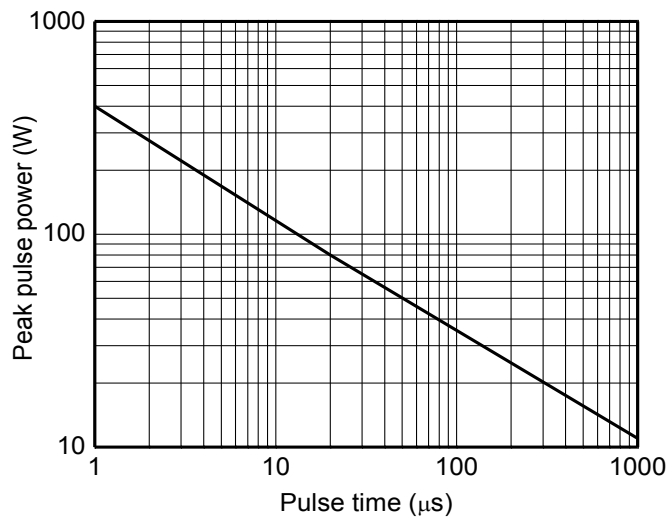
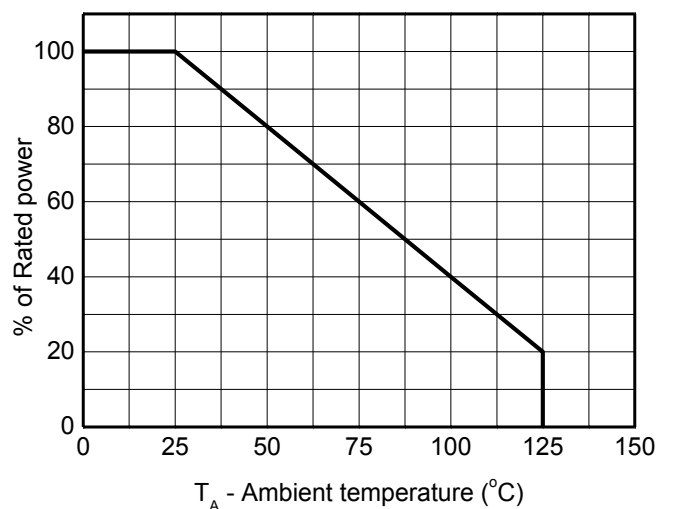
- 1) TLP parameter: Z<sub>0</sub> = 50Ω, t<sub>p</sub> = 100ns, t<sub>r</sub> = 2ns, averaging window from 60ns to 80ns. R<sub>DYN</sub> is calculated from 4A to 16A.
- 2) Contact discharge mode, according to IEC61000-4-2.
- 3) Non-repetitive current pulse, according to IEC61000-4-5.

**Typical characteristics ( $T_A=25^\circ\text{C}$ , unless otherwise noted)**

**8/20μs waveform per IEC61000-4-5**

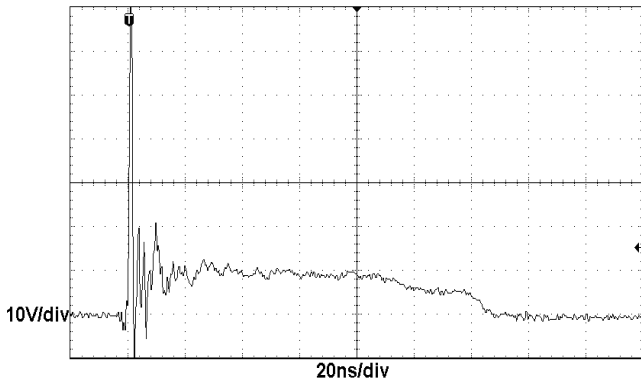
**Contact discharge current waveform per IEC61000-4-2**

**Clamping voltage vs. Peak pulse current**

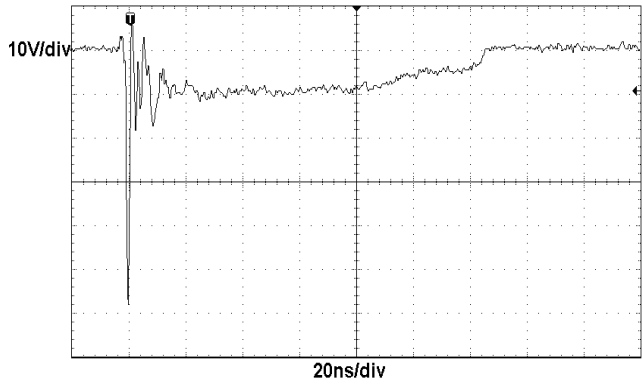
**Capacitance vs. Reverse voltage**

**Non-repetitive peak pulse power vs. Pulse time**

**Power derating vs. Ambient temperature**

Typical characteristics ( $T_A=25^\circ\text{C}$ , unless otherwise noted)



**ESD clamping**  
 (+8kV contact discharge per IEC61000-4-2)



**ESD clamping**  
 (-8kV contact discharge per IEC61000-4-2)

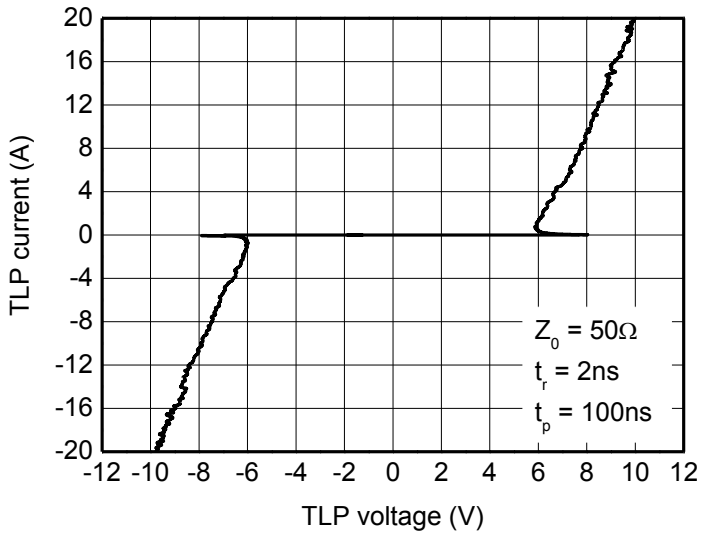

**TLP Measurement**

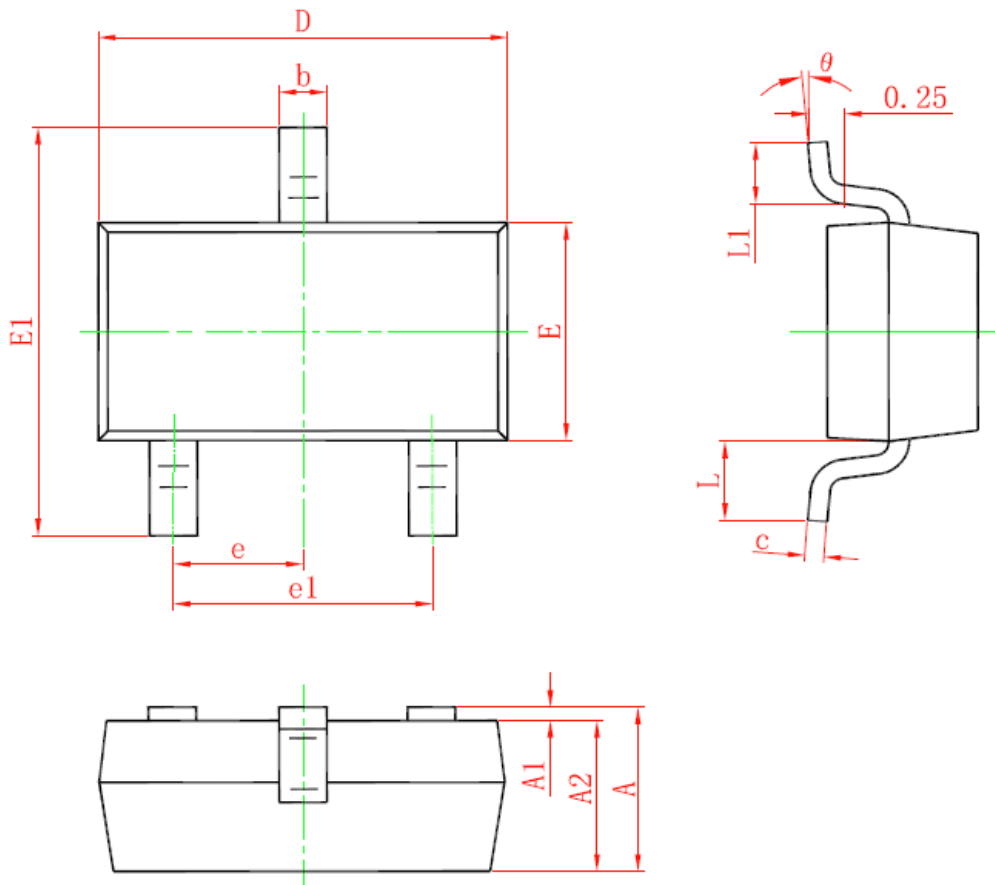
**Package outline dimensions**
**SOT-23**

Symbol	Dimensions in millimeters		Dimensions in inches	
	Min.	Max.	Min.	Max.
A	0.900	1.150	0.035	0.045
A1	0.000	0.100	0.000	0.004
A2	0.900	1.050	0.035	0.041
b	0.300	0.500	0.012	0.020
c	0.080	0.150	0.003	0.006
D	2.800	3.000	0.110	0.118
E	1.200	1.400	0.047	0.055
E1	2.250	2.550	0.089	0.100
e	0.950TYP		0.037TYP	
e1	1.800	2.000	0.071	0.079
L	0.550REF		0.022REF	
L1	0.300	0.500	0.012	0.020
$\theta$	0°	8°	0°	8°