

ESD53101N
<http://www.sh-willsemi.com>
**1-Line, Uni-directional, Ultra-low Capacitance
Transient Voltage Suppressor**
Descriptions

The ESD53101N is an ultra-low capacitance TVS (Transient Voltage Suppressor) designed to protect high speed data interfaces. It has been specifically designed to protect sensitive electronic components which are connected to data and transmission lines from over-stress caused by ESD (Electrostatic Discharge).

The ESD53101N incorporates one pair of Ultra-low capacitance steering diodes plus a TVS diode.

The ESD53101N may be used to provide ESD protection up to $\pm 30\text{kV}$ (contact discharge) according to IEC61000-4-2, and withstand peak pulse current up to 10A (8/20 μs) according to IEC61000-4-5.

The ESD53101N is available in DFN1006-2L package. Standard products are Pb-free and Halogen-free.

Features

- Stand-off voltage: 5V Max
- Transient protection for each line according to IEC61000-4-2 (ESD): $\pm 30\text{kV}$ (contact discharge)
IEC61000-4-5 (surge): 10A (8/20 μs)
- Ultra-low capacitance: $C_J = 1.1\text{pF}$ typ.
- Ultra-low leakage current: $I_R = <10\text{nA}$ typ.
- Low clamping voltage: $V_{CL} = 9.8\text{V}$ typ. @ $I_{PP} = 16\text{A}$ (TLP)
- Solid-state silicon technology

Applications

- USB Interface
- DVI Interface
- Portable Electronics
- Notebooks

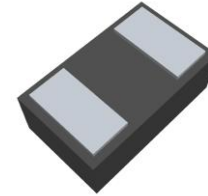
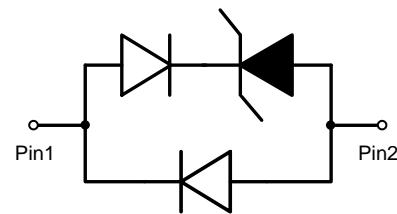
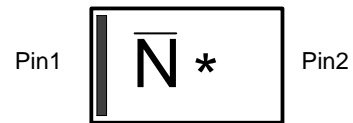
DFN1006-2L (Bottom View)

Pin configuration

 \bar{N} = Device code

* = Month code (A~Z)

Marking (Top View)
Order information

Device	Package	Shipping
ESD53101N-2/TR	DFN1006-2L	10000/Tape&Reel

Absolute maximum ratings

Parameter	Symbol	Rating	Unit
Peak pulse power ($t_p = 8/20\mu s$)	P_{pk}	110	W
Peak pulse current ($t_p = 8/20\mu s$)	I_{PP}	10	A
ESD according to IEC61000-4-2 air discharge	V_{ESD}	± 30	kV
ESD according to IEC61000-4-2 contact discharge		± 30	
Operation junction temperature	T_J	125	$^{\circ}C$
Lead temperature	T_L	260	$^{\circ}C$
Storage temperature	T_{STG}	-55~150	$^{\circ}C$

Electrical characteristics ($T_A=25^{\circ}C$, unless otherwise noted)

Parameter	Symbol	Condition	Min.	Typ.	Max.	Unit
Reverse maximum working voltage	V_{RWM}				5.0	V
Reverse leakage current	I_R	$V_{RWM} = 5V$			100	nA
Reverse breakdown voltage	V_{BR}	$I_T = 1mA$	7.0	8.0	9.0	V
Forward voltage	V_F	$I_T = 10mA$	0.6	0.9	1.2	V
Clamping Voltage ¹⁾	V_{CL}	$I_{PP} = 16A, t_p = 100ns$		9.8		V
Clamping voltage ²⁾	V_{CL}	$V_{ESD} = 8kV$		11.5		V
Dynamic resistance ¹⁾	R_{DYN}			0.12		Ω
Clamping voltage ³⁾	V_{CL}	$I_{PP} = 1A, t_p = 8/20\mu s$			9	V
		$I_{PP} = 10A, t_p = 8/20\mu s$			11	V
Junction capacitance	C_J	$V_R = 0V, f = 1MHz$		1.1	1.2	pF

1) TLP parameter: $Z_0 = 50 \Omega$, $t_p = 100ns$, $t_r = 2ns$, averaging window from 60ns to 80ns. R_{DYN} is calculated from 4A to 16A.

2) According to IEC61000-4-5.

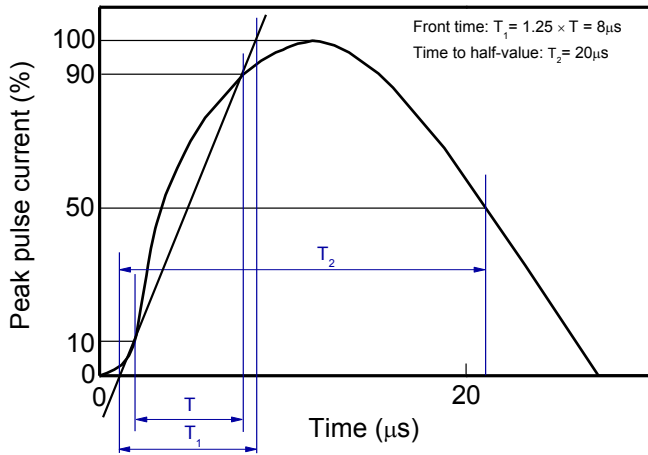
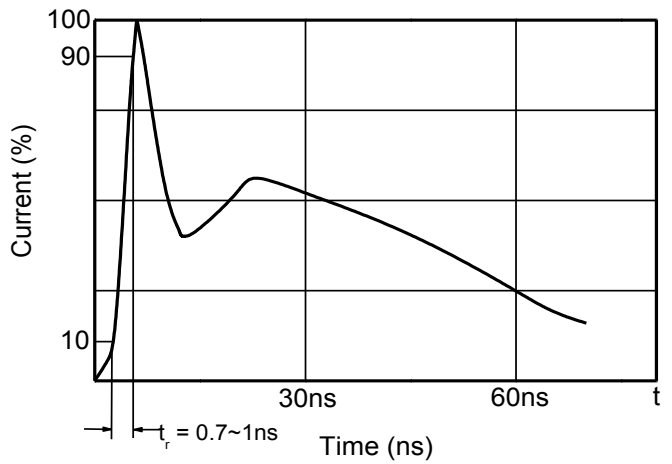
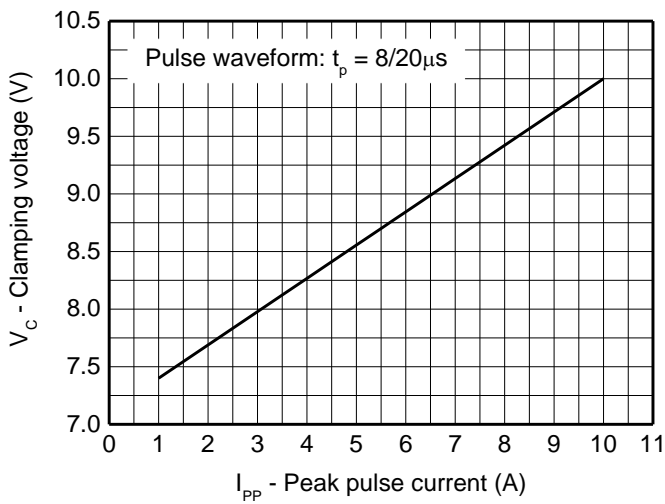
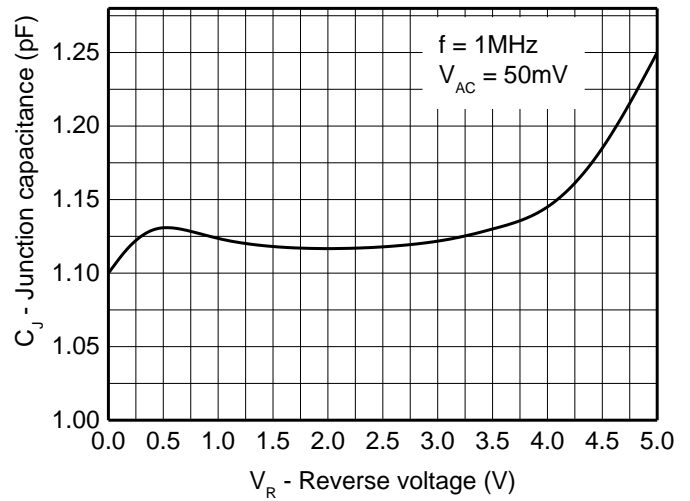
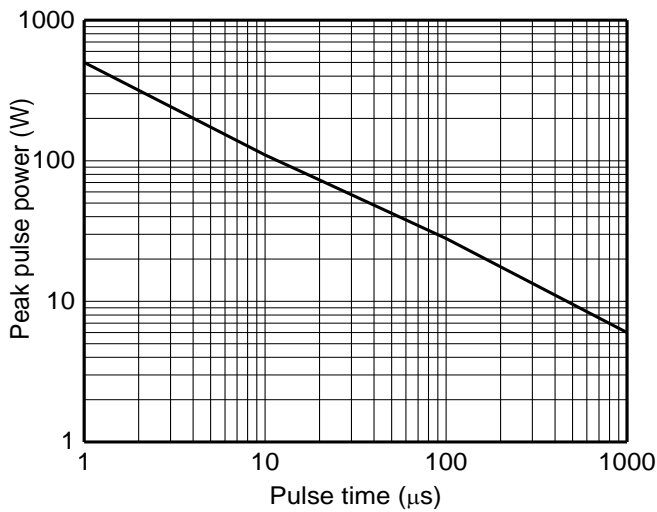
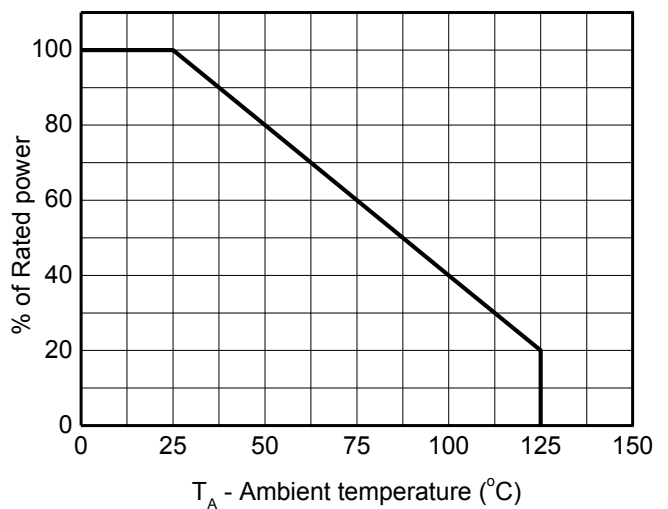
Typical characteristics ($T_A=25^\circ\text{C}$, unless otherwise noted)

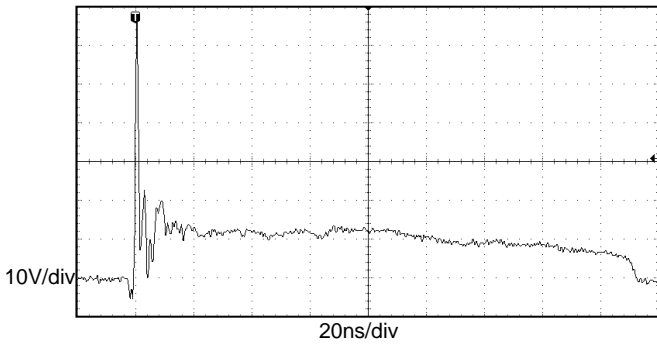
8/20 μs waveform per IEC61000-4-5

Contact discharge current waveform per IEC61000-4-2

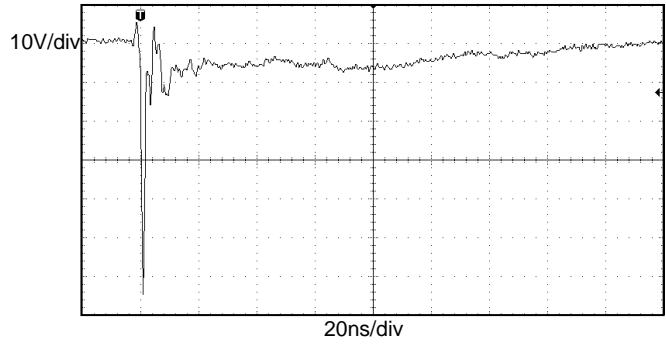
Clamping voltage vs. Peak pulse current

Capacitance vs. Reverse voltage

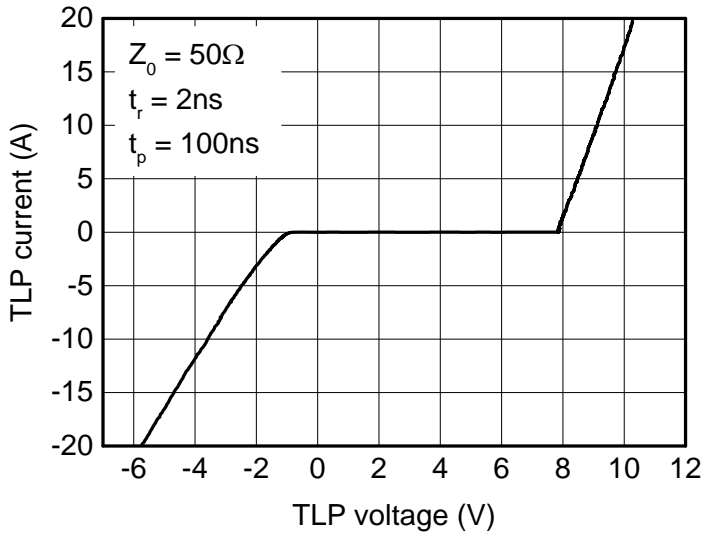
Non-repetitive peak pulse power vs. Pulse time

Power derating vs. Ambient temperature



ESD clamping
 (+8kV contact discharge per IEC61000-4-2)



ESD clamping
 (-8kV contact discharge per IEC61000-4-2)

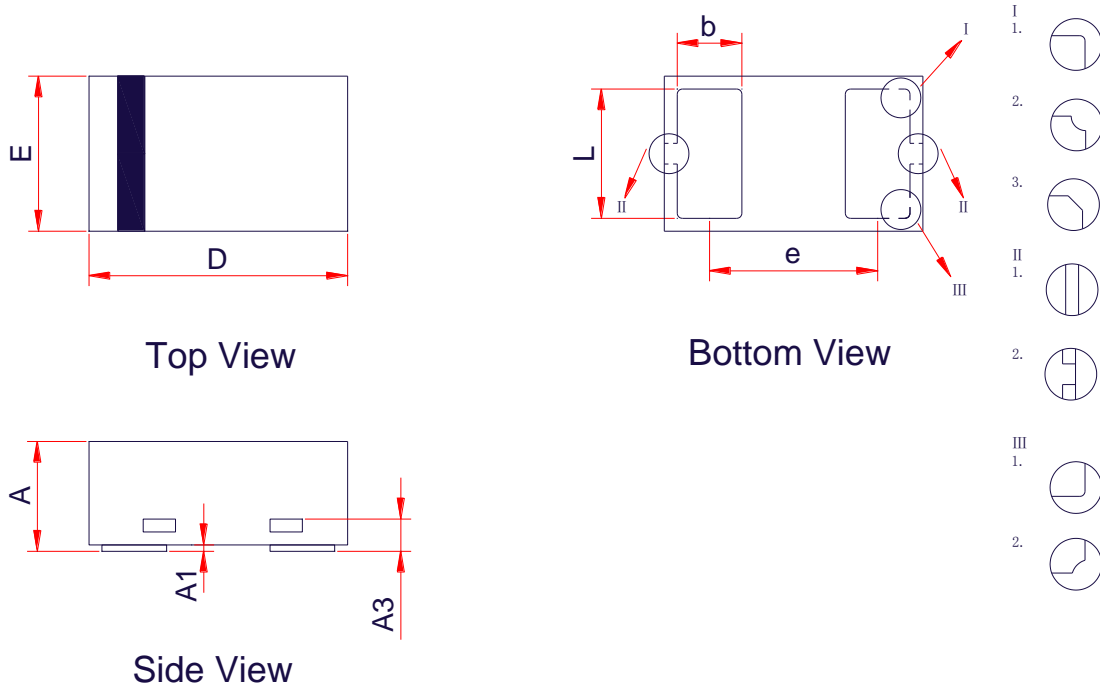

TLP Measurement

Package outline dimensions
DFN1006-2L

Symbol	Dimensions in Millimeters		
	Min.	Typ.	Max.
A	0.34	0.45	0.53
A1	0.00	0.02	0.05
A3	0.12 Ref.		
D	0.95	1.00	1.08
E	0.55	0.60	0.68
b	0.20	0.25	0.30
L	0.45	0.50	0.55
e	0.65 BSC		

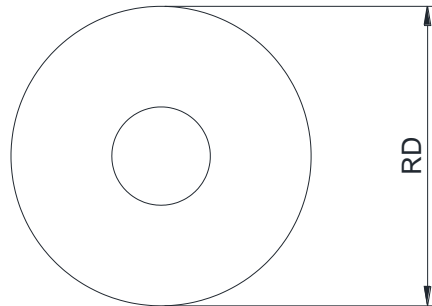
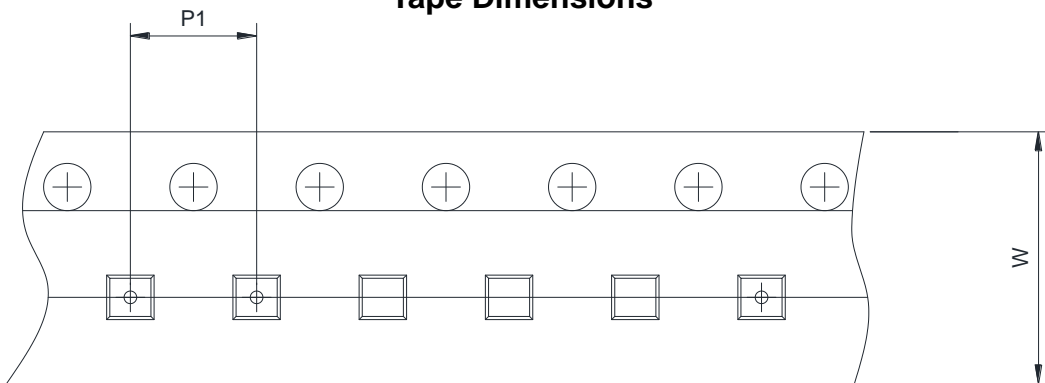
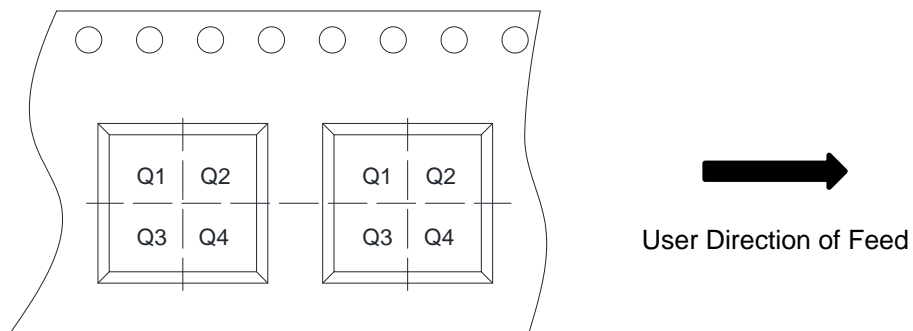
TAPE AND REEL INFORMATION
Reel Dimensions

Tape Dimensions

Quadrant Assignments For PIN1 Orientation In Tape

RD	Reel Dimension	<input checked="" type="checkbox"/> 7inch	<input type="checkbox"/> 13inch	
W	Overall width of the carrier tape	<input checked="" type="checkbox"/> 8mm	<input type="checkbox"/> 12mm	<input type="checkbox"/> 16mm
P1	Pitch between successive cavity centers	<input checked="" type="checkbox"/> 2mm	<input type="checkbox"/> 4mm	<input type="checkbox"/> 8mm
Pin1	Pin1 Quadrant	<input checked="" type="checkbox"/> Q1	<input checked="" type="checkbox"/> Q2	<input type="checkbox"/> Q3 <input type="checkbox"/> Q4