



Photocoupler  
Product Data Sheet  
LTV-314N series

Spec No. :DS70-2017-0051  
Effective Date: 07/04/2017  
Revision: -

**LITE-ON DCC**

**RELEASE**

**BNS-OD-FC001/A4**

## Photocoupler LTV-314N series

### 1.0 Amp Output Current IGBT Gate Drive Photocoupler in Stretched SO6

#### 1. Description

The LTV-314N series Photocoupler is ideally suited for driving power IGBTs and MOSFETs used in motor control inverter applications and inverters in power supply system. It contains an AlGaAs LED optically coupled to an integrated circuit with a power output stage. The Photocoupler operational parameters are guaranteed over the temperature range from -40°C ~ +105°C.

##### 1.1 Features

- 1.0 A maximum peak output current
- 0.8 A minimum peak output current
- 500 ns maximum propagation delay
- 200 ns maximum propagation delay difference
- Under Voltage Lock-Out protection (UVLO) with hysteresis
- 35 kV/us minimum Common Mode Rejection (CMR) at  $V_{CM} = 1500\text{ V}$
- Wide operating range: 10 to 30 Volts ( $V_{CC}$ )
- Guaranteed performance over temperature -40°C ~ +105°C.
- MSL Level 1
- Safety approval:

UL 1577 recognized with 5000  $V_{RMS}$  for 1 minute for

LTV-314NP and LTV-314NW

VDE DIN EN 60747-5-5 Approved

$V_{IORM} = 891V_{peak}$  for LTV-314NP

$V_{IORM} = 1140V_{peak}$  for LTV-314NW

##### 1.2 Applications

- IGBT/MOSFET gate drive
- Uninterruptible power supply (UPS)
- Industrial Inverter
- AC/Brushless DC motor drives
- Switching power suppliers

##### Functional Diagram

Pin No. and Internal connection diagram

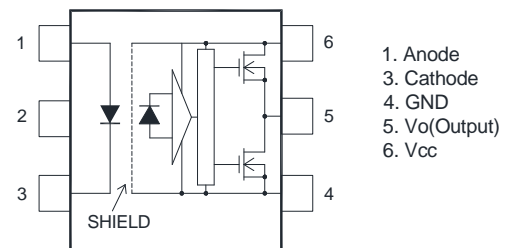

##### Truth Table

| LED | High side | Low side | $V_o$ |
|-----|-----------|----------|-------|
| OFF | OFF       | ON       | Low   |
| ON  | ON        | OFF      | High  |

Note: A 0.1 $\mu$ F bypass capacitor must be connected between Pin 4 and 6.

## Photocoupler LTV-314N series

### 2. PACKAGE DIMENSIONS

#### 2.1 LTV-314NW

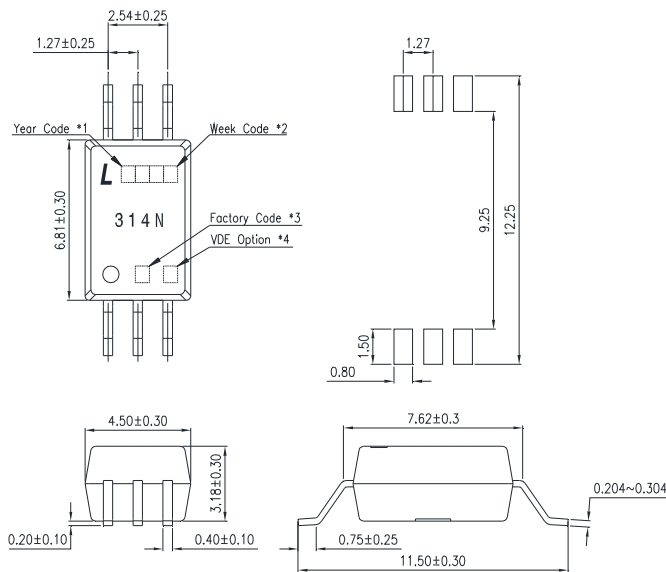

#### 2.2 LTV-314NP

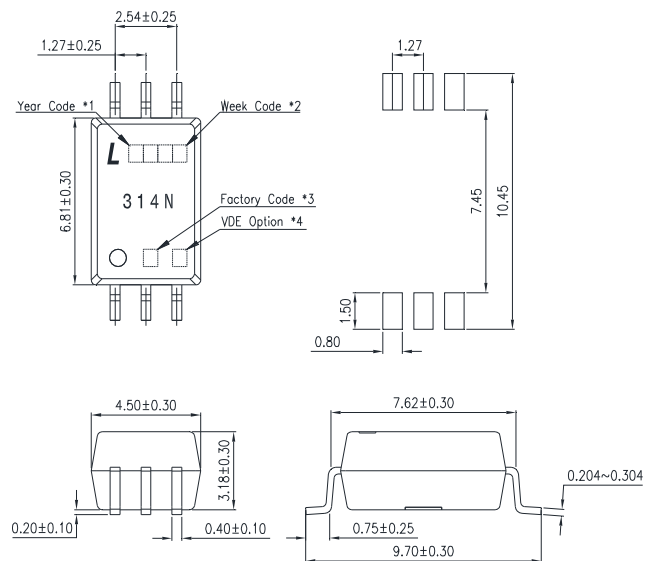

#### Notes :

1. Year date code.
2. 2-digit work week.
3. Factory identification mark (Y : Thailand).
4. "4" or "V" for VDE option.

\* Dimensions are in Millimeters and (Inches).

## Photocoupler LTV-314N series

### 3. TAPING DIMENSIONS

#### 3.1 LTV-314NW-TA

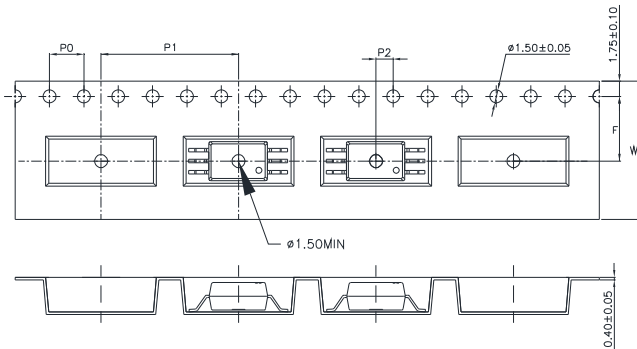

#### 3.2 LTV-314NW-TA1

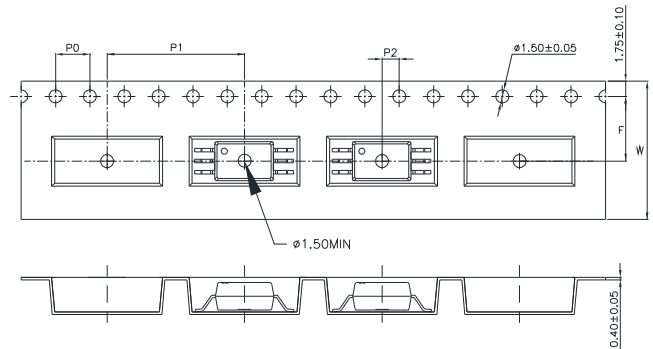

#### 3.3 LTV-314NP-TA

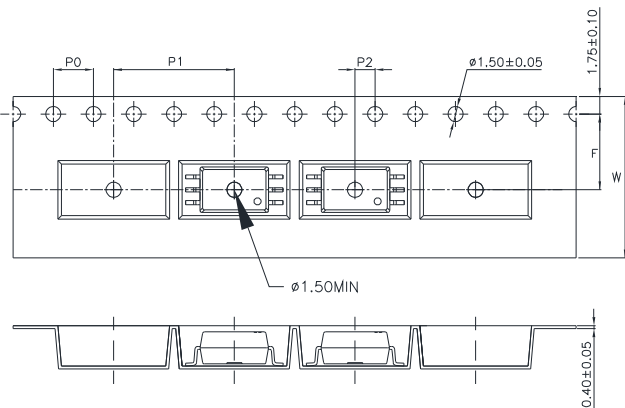

#### 3.4 LTV-314NP-TA1

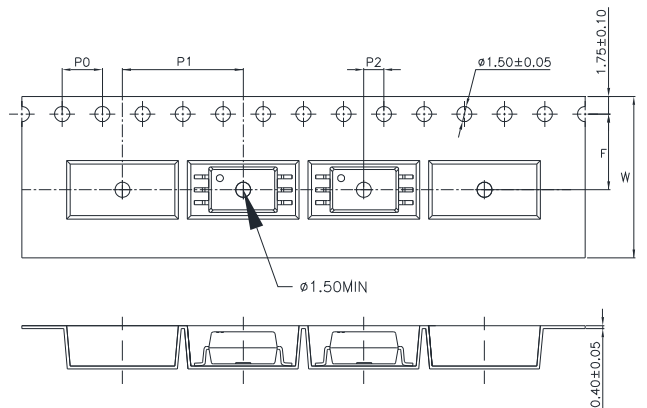

| Description                            | Symbol         | Dimension in mm (inch) |               |
|--|----------------|------------------------|---------------|
|  |                | For W type             | For P type    |
| Tape wide                              | W              | 16±0.3 (0.63)          | 16±0.3 (0.63) |
| Pitch of sprocket holes                | P <sub>0</sub> | 4±0.1 (0.16)           | 4±0.1 (0.16)  |
| Distance of compartment                | F              | 7.5±0.1 (0.3)          | 7.5±0.1 (0.3) |
|  | P <sub>2</sub> | 2±0.1 (0.079)          | 2±0.1 (0.079) |
| Distance of compartment to compartment | P <sub>1</sub> | 16±0.1 (0.63)          | 12±0.1 (0.47) |

#### 3.5 Quantities Per Reel

| Package Type     | LTV-314N series |
|------------------|-----------------|
| Quantities (pcs) | 1000            |

## Photocoupler LTV-314N series

### 4. IEC/EN/DIN EN 60747-5-5 Insulation Characteristics

| Description  | Symbol          | LTV-314NP        | LTV-314NW        | Unit       |
|--|-----------------|------------------|------------------|------------|
| Climatic Classification  | —               | 55/100/21        | 55/100/21        | —          |
| Pollution Degree (DIN VDE 0110/1.89)   | —               | 2                | 2                | —          |
| Maximum Working Insulation Voltage   | $V_{IORM}$      | 891              | 1140             | $V_{peak}$ |
| Input to Output Test Voltage, Method b*<br>$V_{IORM} \times 1.875 = V_{PR}$ , 100% Production Test with<br>$t_m = 1$ sec, Partial discharge < 5 pC | $V_{PR}$        | 1671             | 2137             | $V_{peak}$ |
| Input to Output Test Voltage, Method a*<br>$V_{IORM} \times 1.6 = V_{PR}$ , Type and Sample Test, $t_m = 10$ sec,<br>Partial discharge < 5 pC      | $V_{PR}$        | 1426             | 1824             | $V_{peak}$ |
| Highest Allowable Overvoltage<br>(Transient Overvoltage $t_{ini} = 60$ sec)  | $V_{IOTM}$      | 6000             | 8000             | $V_{peak}$ |
| Safety-limiting values – maximum values allowed in the event of a failure.   |                 |                  |                  |            |
| Case Temperature   | $T_S$           | 175              | 175              | °C         |
| Input Current  | $I_{S, INPUT}$  | 150              | 150              | mA         |
| Output Power   | $P_{S, OUTPUT}$ | 600              | 600              | mW         |
| Insulation Resistance at $T_S$ , $V_{IO} = 500$ V  | $R_S$           | >10 <sup>9</sup> | >10 <sup>9</sup> | Ω          |

\* Refer to the optocoupler section of the Isolation and Control Components Designer's Catalog, under Product Safety Regulations section, (IEC/EN/DIN EN 60747-5-5) for a detailed description of Method a and Method b partial discharge test profiles.

Note: These optocouplers are suitable for "safe electrical isolation" only within the safety limit data. Maintenance of the safety data shall be ensured by means of protective circuits. Surface mount classification is Class A in accordance with CECC 00802.

#### 4.1 Insulation and Safety Related Specification

| Parameter  | Symbol | LTV-314NP | LTV-314NW | Unit | Test Condition  |
|--|--------|-----------|-----------|------|---|
| Minimum External Air Gap (External Clearance)    | L(101) | 7.0       | 8.0       | mm   | Measured from input terminals to output terminals, shortest distance through air. |
| Minimum External Tracking (External Clearance)   | L(102) | 8.0       | 8.0       | mm   | Measured from input terminals to output terminals, shortest distance              |
| Tracking Resistance (Comparative Tracking Index) | CTI    | >175      | >175      | V    | DIN EN 60112<br>(VDE 0303 Teil 11)  |

## Photocoupler LTV-314N series

### 5. RATING AND CHARACTERISTICS

#### 5.1 Absolute Maximum Ratings

| Parameter                      | Symbol                  | Min | Max      | Unit | Note |
|--------------------------------|-------------------------|-----|----------|------|------|
| Storage Temperature            | $T_{stg}$               | -55 | +125     | °C   | —    |
| Operating Temperature          | $T_{opr}$               | -40 | +105     | °C   | —    |
| Output IC Junction Temperature | $T_J$                   | —   | 125      | °C   | —    |
| Total Output Supply Voltage    | $(V_{CC}-V_{EE})$       | 0   | 35       | V    | —    |
| Average Forward Input Current  | $I_F$                   | —   | 25       | mA   | —    |
| Reverse Input Voltage          | $V_R$                   | —   | 5        | V    | —    |
| Peak Transient Input Current   | $I_{F(TRAN)}$           | —   | 1.0      | A    | 1    |
| “High” Peak Output Current     | $I_{OH(PEAK)}$          | —   | 1.0      | A    | 2    |
| “Low” Peak Output Current      | $I_{OL(PEAK)}$          | —   | 1.0      | A    | 2    |
| Input Current (Rise/Fall Time) | $t_{r(IN)} / t_{f(IN)}$ | —   | 500      | ns   | 3    |
| Output Voltage                 | $V_{O(PEAK)}$           | —   | $V_{CC}$ | V    | —    |
| Power Dissipation              | $P_I$                   | —   | 45       | mW   | —    |
| Output IC Power Dissipation    | $P_O$                   | —   | 250      | mW   | —    |
| Total Power Dissipation        | $P_T$                   | —   | 295      | mW   | —    |
| Lead Solder Temperature        | $T_{sol}$               | —   | 260      | °C   | —    |

Note: Ambient temperature = 25°C, unless otherwise specified. Stresses exceeding the absolute maximum ratings can cause permanent damage to the device. Exposure to absolute maximum ratings for long periods of time can adversely affect reliability.

Note: A ceramic capacitor (0.1  $\mu$ F) should be connected between pin 6 and pin 4 to stabilize the operation of a high gain linear amplifier. Otherwise, this Photocoupler may not switch properly. The bypass capacitor should be placed within 1 cm of each pin.

Note 1: Pulse width (PW)  $\leq$  1  $\mu$ s, 300 pps

Note 2: Exponential waveform. Pulse width  $\leq$  0.3  $\mu$ s,  $f \leq$  15 kHz

Note 3: The rise and fall times of the input on-current should be less than 500 ns

#### 5.2 Recommended Operating Conditions

| Parameter             | Symbol       | Min  | Max | Unit |
|-----------------------|--------------|------|-----|------|
| Operating Temperature | $T_A$        | -40  | 105 | °C   |
| Supply Voltage        | $V_{CC}$     | 10   | 30  | V    |
| Input Current (ON)    | $I_{FL(ON)}$ | 7    | 16  | mA   |
| Input Voltage (OFF)   | $V_{F(OFF)}$ | -3.0 | 0.8 | V    |

## Photocoupler LTV-314N series

### 5.3 ELECTRICAL OPTICAL CHARACTERISTICS

|                 | Parameter                                     | Symbol                  | Min.         | Typ.            | Max.           | Unit                                 | Test Condition                                       | Figure       | Note |
|-----------------|---|-------------------------|--------------|-----------------|----------------|--------------------------------------|--|--------------|------|
| Input           | Input Forward Voltage                         | $V_F$                   | 1.2          | 1.37            | 1.8            | V                                    | $I_F = 10\text{mA}$                                  | 13           | —    |
|                 | Input Forward Voltage Temperature Coefficient | $\Delta V_F / \Delta T$ | —            | -1.237          | —              | mV/°C                                | $I_F = 10\text{mA}$                                  | —            | —    |
|                 | Input Reverse Voltage                         | $BV_R$                  | 5            | —               | —              | V                                    | $I_R = 10\mu\text{A}$                                | —            | —    |
|                 | Input Threshold Current (Low to High)         | $I_{FLH}$               | —            | 1.9             | 5              | mA                                   | $V_O > 5\text{V}, I_O = 0\text{A}$                   | 9, 18        | —    |
|                 | Input Threshold Voltage (High to Low)         | $V_{FHL}$               | 0.8          | —               | —              | V                                    | $V_O < 5\text{V}, I_O = 0\text{A}$                   | —            | —    |
|                 | Input Capacitance                             | $C_{IN}$                | —            | 33              | —              | pF                                   | $f = 1\text{MHz}, V_F = 0\text{V}$                   | —            | —    |
| Output          | High Level Supply Current                     | $I_{CCH}$               | —            | 1.9             | 3.0            | mA                                   | $I_F = 7\text{ to }16\text{mA}, V_O = \text{Open}$   | 5, 6<br>7, 8 | —    |
|                 | Low Level Supply Current                      | $I_{CCL}$               | —            | 2.1             | 3.0            | mA                                   | $V_F = -3\text{ to }+0.8\text{V}, V_O = \text{Open}$ | —            | —    |
|                 | High level output current                     | $I_{OH}$                | —            | —               | -0.3           | A                                    | $V_O = (V_{CC} - 3\text{V})$                         | 3, 16        | 1    |
|                 |   |                         | —            | —               | -0.8           |                                      | $V_O = (V_{CC} - 6\text{V})$                         |              | 2    |
|                 | Low level output current                      | $I_{OL}$                | 0.3          | —               | —              | A                                    | $V_O = (V_{EE} + 1.5\text{V})$                       | 4, 17        | 1    |
|                 |   |                         | 0.8          | —               | —              |                                      | $V_O = (V_{EE} + 3\text{V})$                         |              | 2    |
|                 | High level output voltage                     | $V_{OH}$                | $V_{CC} - 4$ | $V_{CC} - 1.5$  | —              | V                                    | $I_F = 10\text{mA}, I_O = -100\text{mA}$             | 1, 14        | —    |
|                 | Low level output voltage                      | $V_{OL}$                | —            | $V_{EE} + 0.25$ | $V_{EE} + 0.4$ | V                                    | $I_F = 0\text{mA}, I_O = 100\text{mA}$               | 2, 15        | —    |
|                 | UVLO Threshold                                | $V_{UVLO+}$             | —            | 7.8             | —              | V                                    | $V_O > 5\text{V}, I_F = 10\text{mA}$                 | 19           | —    |
| $V_{UVLO-}$     |   | —                       | 6.7          | —               | V              | $V_O < 5\text{V}, I_F = 10\text{mA}$ | —  |              |      |
| UVLO Hysteresis | $UVLO_{HYS}$                                  | —                       | 1.1          | —               | V              | —                                    | —  | —            |      |

All Typical values at  $T_A = 25^\circ\text{C}$  and  $V_{CC} - V_{EE} = 10\text{ to }30\text{V}$ , unless otherwise specified; all minimum and maximum specifications are at recommended operating condition. (Refer to 5.2)

Note 1: Maximum pulse width = 50  $\mu\text{s}$ .

Note 2: Maximum pulse width = 10  $\mu\text{s}$ .

## Photocoupler LTV-314N series

### 6. SWITCHING SPECIFICATION

| Parameter  | Symbol    | Min. | Typ. | Max. | Unit        | Test Condition  | Figure            | Note |
|--|-----------|------|------|------|-------------|---|-------------------|------|
| Propagation Delay Time to High Output Level                    | $t_{PLH}$ | 50   | 250  | 500  | ns          | $R_g = 47\Omega$ ,<br>$C_g = 3nF$ ,<br>$f = 10\text{ kHz}$ ,<br>Duty Cycle = 50%<br>$I_F = 7\text{ to }16\text{ mA}$ ,<br>$V_{CC} = 10\text{ to }30V$<br>$V_{EE} = \text{ground}$ | 10, 11,<br>12, 20 | —    |
| Propagation Delay Time to Low Output Level                     | $t_{PHL}$ | 50   | 250  | 500  |             |   |                   | —    |
| Pulse Width Distortion   | PWD       | —    | 30   | 200  |             |   |                   | —    |
| Propagation delay difference between any two parts or channels | PDD       | -200 | —    | 200  |             |   | 3                 |      |
| Output Rise Time (10 to 90%)                                   | $T_r$     | —    | 30   | —    |             |   | 20                | —    |
| Output Fall Time (90 to 10%)                                   | $T_f$     | —    | 30   | —    |             |   |                   | —    |
| Common mode transient immunity at high level output            | $ CM_H $  | 35   | 50   | —    | kV/ $\mu$ s | $T_A = 25^\circ\text{C}$ ,<br>$I_F = 7\text{ to }16\text{ mA}$ ,<br>$V_{CM} = 1500\text{ V}$ ,<br>$V_{CC} = 30\text{ V}$  | 21                | 1    |
| Common mode transient immunity at low level output             | $ CM_L $  | 35   | 50   | —    | kV/ $\mu$ s | $T_A = 25^\circ\text{C}$ ,<br>$V_F = 0\text{ V}$ ,<br>$V_{CM} = 1500\text{ V}$ ,<br>$V_{CC} = 30\text{ V}$  |                   | 2    |

All Typical values at  $T_A = 25^\circ\text{C}$  and  $V_{CC} - V_{EE} = 10\text{ to }30\text{ V}$ , unless otherwise specified; all minimum and maximum specifications are at recommended operating condition. (Refer to 5.2)

Note 1:  $CM_H$  is the maximum rate of rise of the common mode voltage that can be sustained with the output voltage in the logic high state ( $V_O > 15\text{ V}$ ).

Note 2:  $CM_L$  is the maximum rate of fall of the common mode voltage that can be sustained with the output voltage in the logic low state ( $V_O < 1\text{ V}$ ).

Note 3: The difference between  $t_{PHL}$  and  $t_{PLH}$  between any two parts series parts under same test conditions.



## Photocoupler LTV-314N series

### 7. ISOLATION CHARACTERISTIC

| Parameter                            | Symbol    | Device                 | Min. | Typ.             | Max. | Unit | Test Condition                                    | Note |
|--------------------------------------|-----------|------------------------|------|------------------|------|------|---|------|
| Withstand Insulation<br>Test Voltage | $V_{ISO}$ | LTV-314NW<br>LTV-314NP | 5000 | —                | —    | V    | RH ≤ 40%-60%,<br>t = 1min, T <sub>A</sub> = 25 °C | 1, 2 |
| Input-Output<br>Resistance           | $R_{I-O}$ | —                      | —    | 10 <sup>12</sup> | —    | Ω    | V <sub>I-O</sub> = 500V DC                        | 1    |
| Input-Output<br>Capacitance          | $C_{I-O}$ | —                      | —    | 0.92             | —    | pF   | f = 1MHz, T <sub>A</sub> = 25 °C                  | 1    |

All Typical values at T<sub>A</sub> = 25°C unless otherwise specified. All minimum and maximum specifications are at recommended operating condition. (Refer to 5.2)

Note 1: Device is considered a two terminal device: pins 1, 2 and 3 are shorted together and pins 4, 5 and 6 are shorted together.

Note 2: According to UL1577, each photocoupler is tested by applying an insulation test voltage 6000V<sub>RMS</sub> for one second (leakage current less than 10uA). This test is performed before the 100% production test for partial discharge

# Photocoupler LTV-314N series

## 8. TYPICAL PERFORMANCE CURVES & TEST CIRCUITS

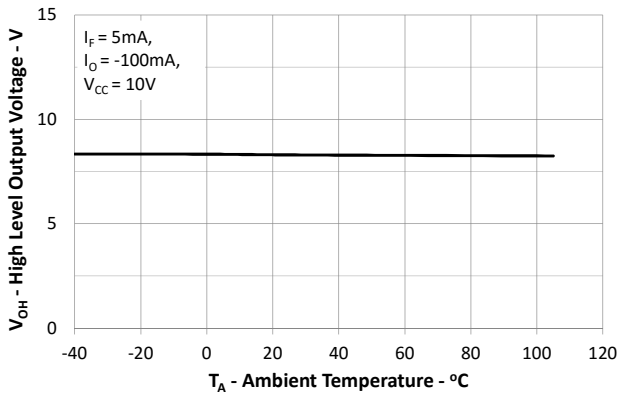

Figure 1.  $V_{OH}$  vs. Temperature

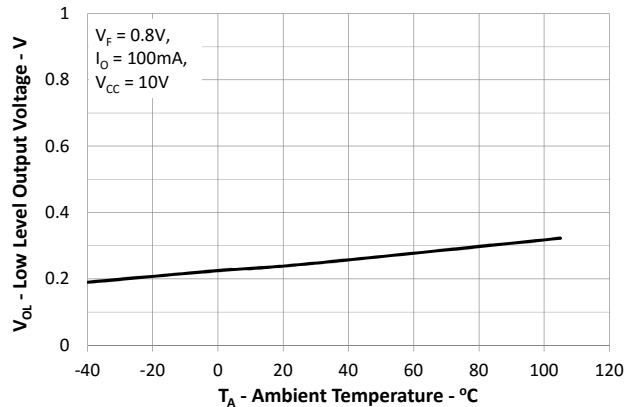

Figure 2.  $V_{OL}$  vs. Temperature

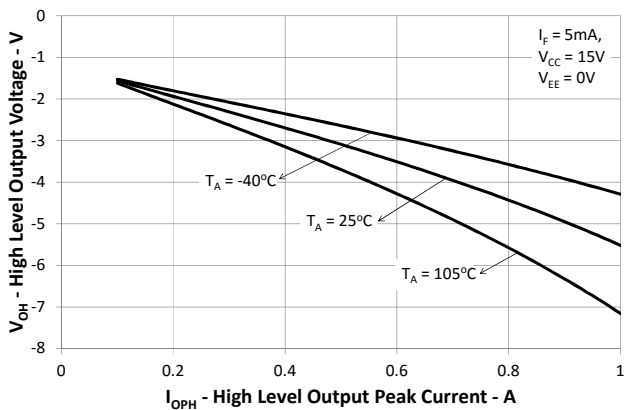

Figure 3.  $V_{OH}$  vs.  $I_{OPH}$

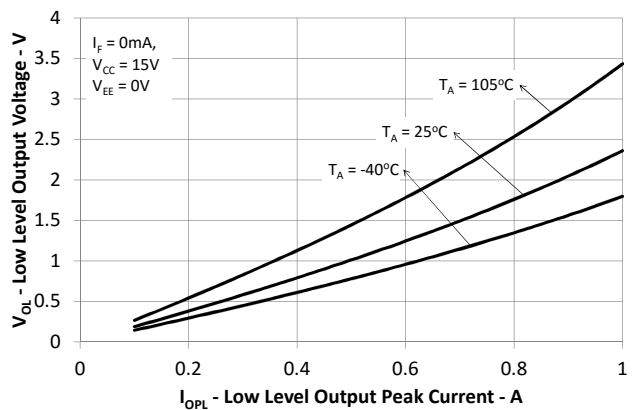

Figure 4.  $V_{OL}$  vs.  $I_{OPL}$

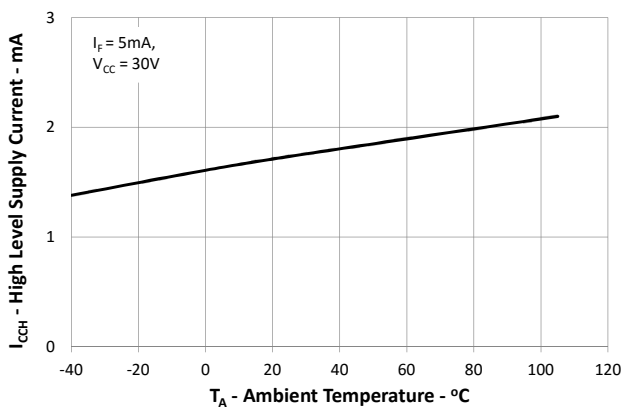

Figure 5.  $I_{CCH}$  vs. Temperature

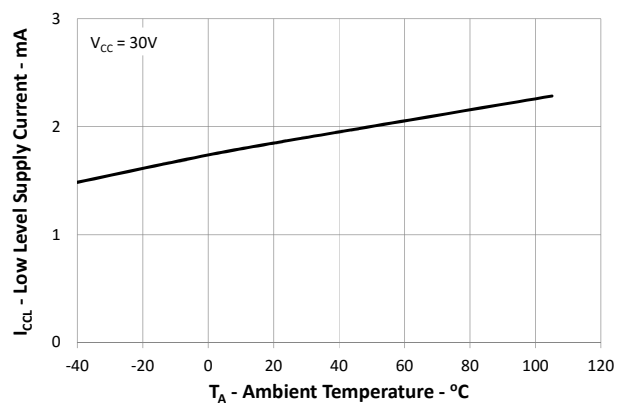

Figure 6.  $I_{CCL}$  vs. Temperature

## Photocoupler LTV-314N series

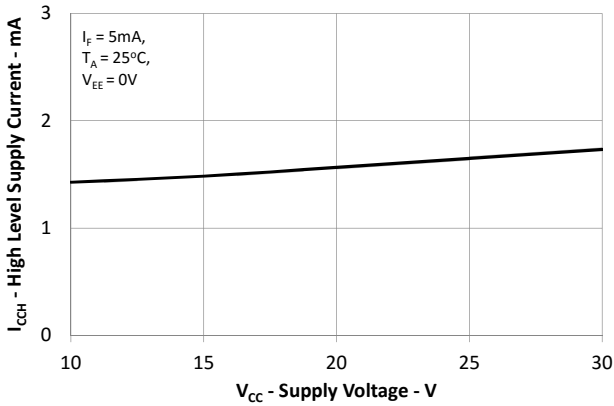

Figure 7.  $I_{cCH}$  vs.  $V_{cc}$

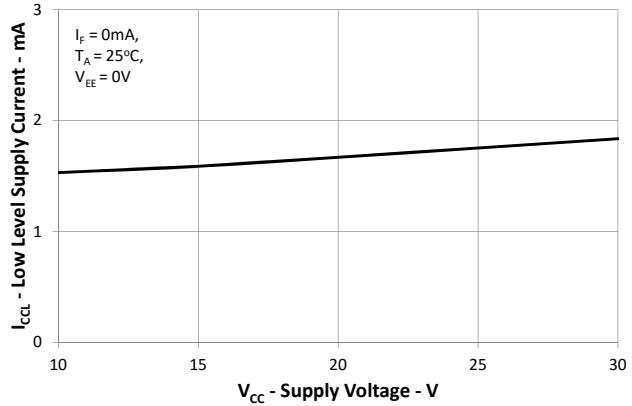

Figure 8.  $I_{cCL}$  vs.  $V_{cc}$

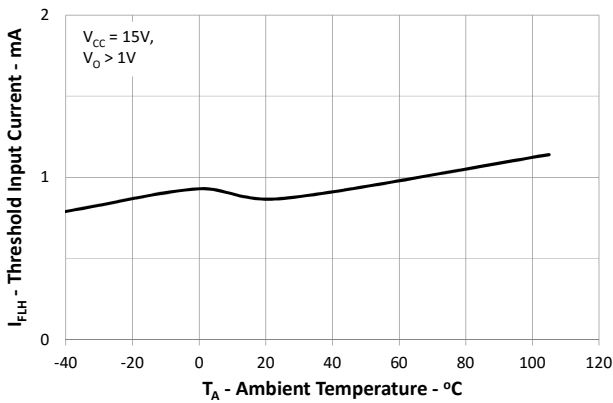

Figure 9.  $I_{FLH}$  vs. Temperature

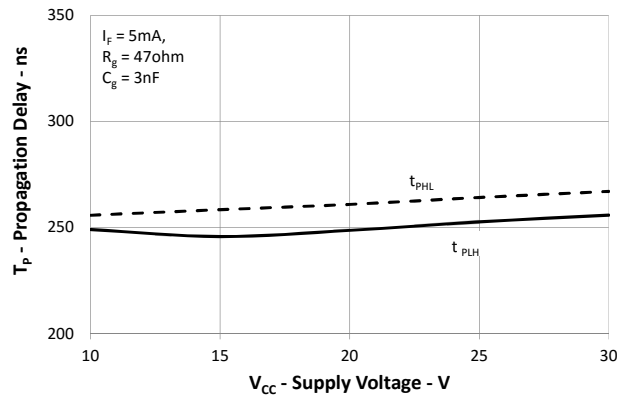

Figure 10. Propagation Delay vs.  $V_{cc}$

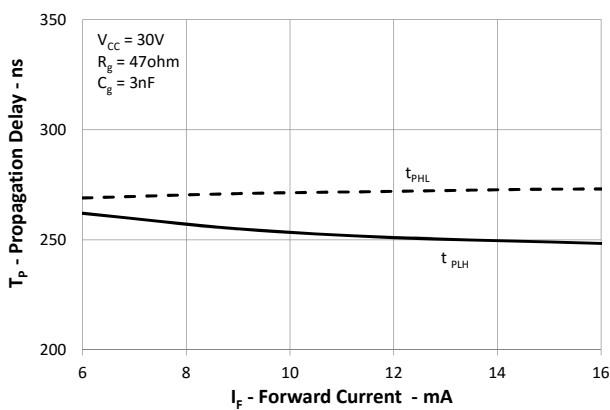

Figure 11. Propagation Delay vs.  $I_f$

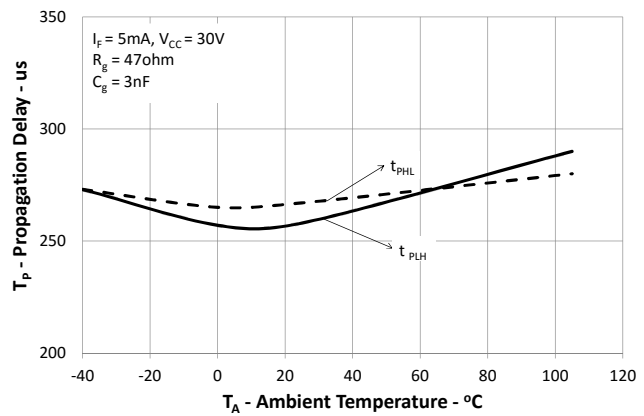

Figure 12. Propagation Delay vs. Temperature

# Photocoupler LTV-314N series

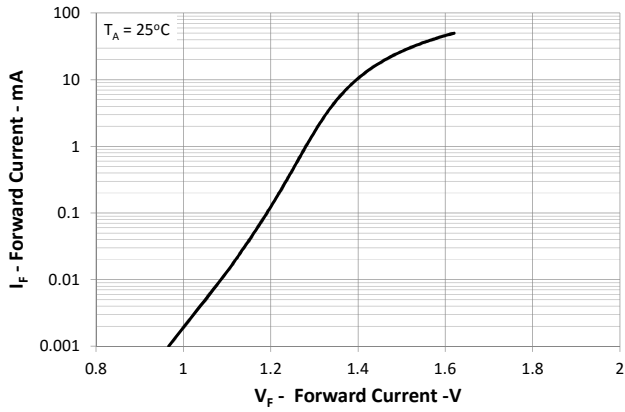

Figure 13. I<sub>F</sub> vs. V<sub>F</sub>

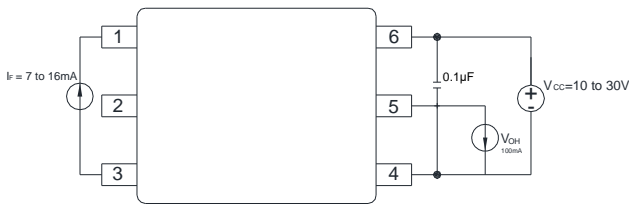

Figure 14 : V<sub>OH</sub> Test Circuit

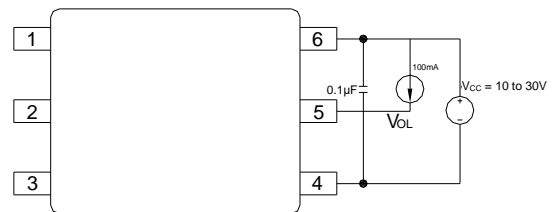

Figure 15 : V<sub>OL</sub> Test Circuit



Figure 16 : I<sub>OH</sub> Test Circuit

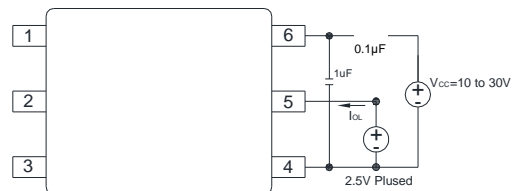

Figure 17 : I<sub>OL</sub> Test Circuit

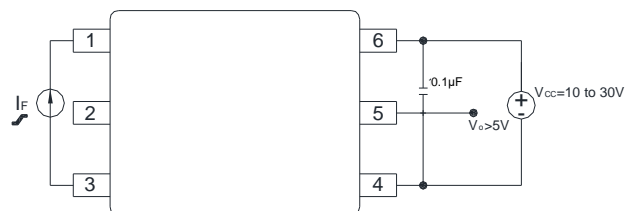

Figure 18 : I<sub>FLH</sub> Test Circuit



Figure 19 : U<sub>VLO</sub> Test Circuit

## Photocoupler LTV-314N series

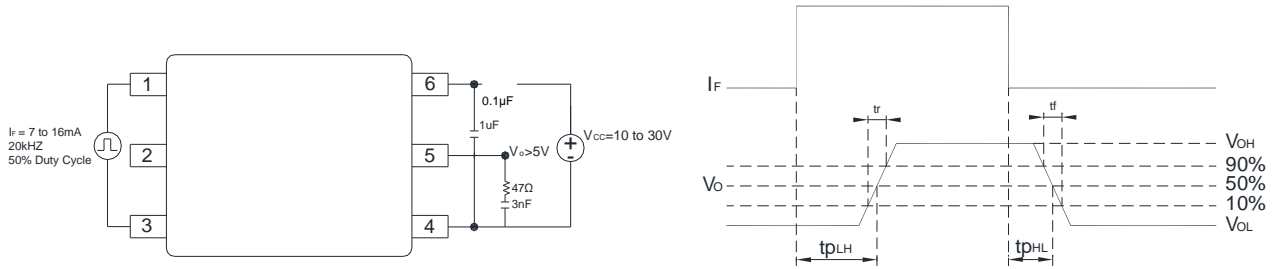

Figure 20 :  $t_r$ ,  $t_f$ ,  $t_{PLH}$  and  $t_{PHL}$  Test Circuit and Waveforms

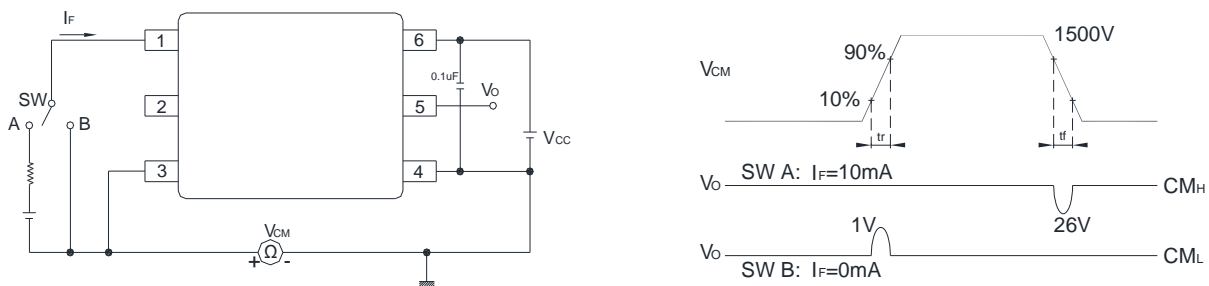

Figure 21 : CMR Test Circuit and Waveforms

## Photocoupler LTV-314N series

### 9. TEMPERATURE PROFILE OF SOLDERING

#### 9.1 IR Reflow soldering (JEDEC-STD-020C compliant)

One time soldering reflow is recommended within the condition of temperature and time profile shown below. Do not solder more than three times.

| Profile item                     | Conditions     |
|----------------------------------|----------------|
| Preheat                          |                |
| - Temperature Min ( $T_{Smin}$ ) | 150°C          |
| - Temperature Max ( $T_{Smax}$ ) | 200°C          |
| - Time (min to max) (ts)         | 90±30 sec      |
| Soldering zone                   |                |
| - Temperature ( $T_L$ )          | 217°C          |
| - Time ( $t_L$ )                 | 60 ~ 100 sec   |
| Peak Temperature ( $T_P$ )       | 260°C          |
| Ramp-up rate                     | 3°C / sec max. |
| Ramp-down rate                   | 3~6°C / sec    |

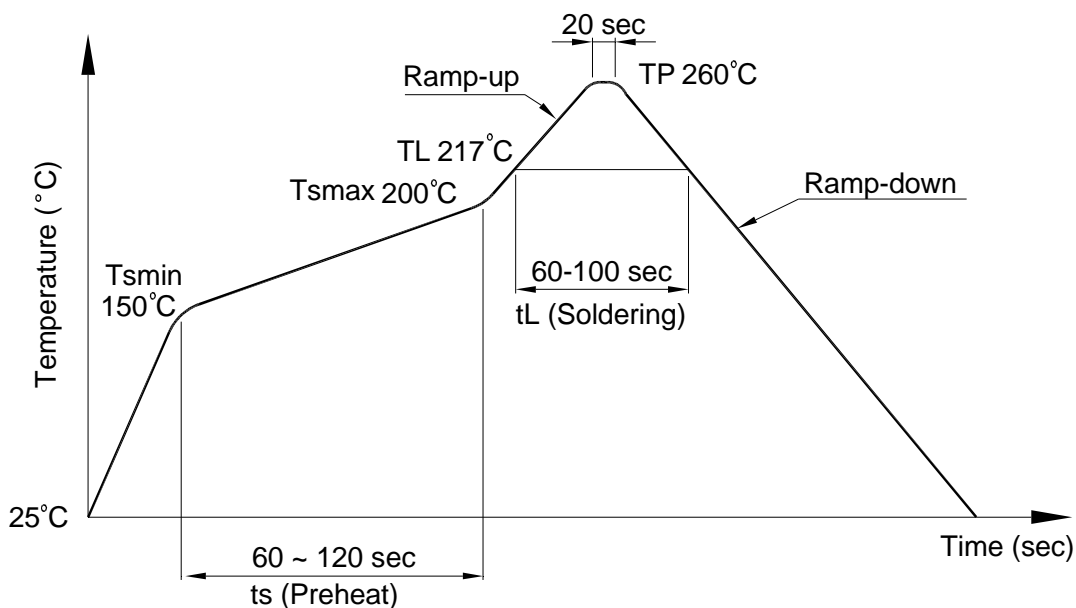

**Photocoupler  
LTV-314N series**

**9.2 Wave soldering (JEDEC22A111 compliant)**

One time soldering is recommended within the condition of temperature.

Temperature:  $260 \pm 0 / -5^{\circ}\text{C}$

Time: 10 sec.

Preheat temperature: 25 to  $140^{\circ}\text{C}$

Preheat time: 30 to 80 sec.

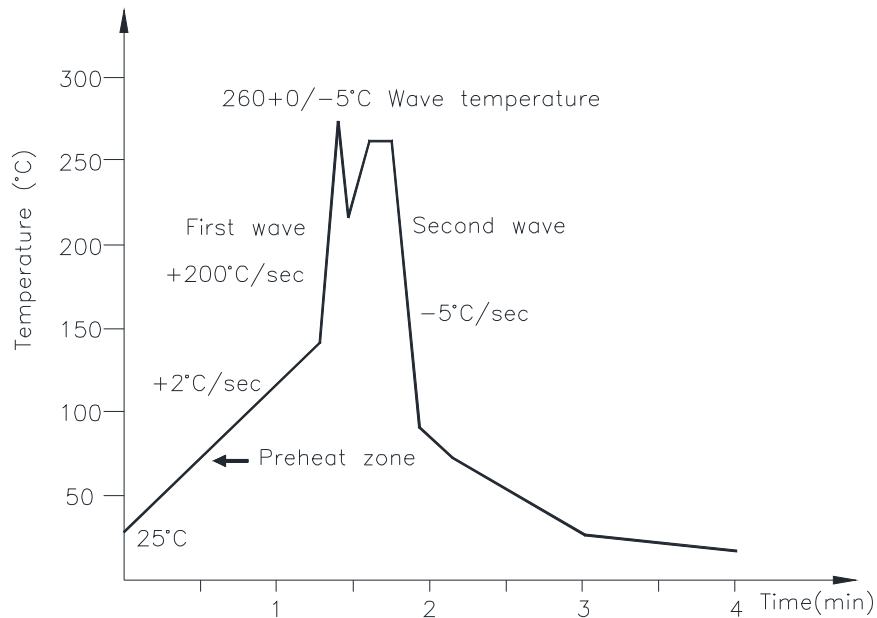

**9.3 Hand soldering by soldering iron**

Allow single lead soldering in every single process. One time soldering is recommended.

Temperature:  $380 \pm 0 / -5^{\circ}\text{C}$

Time: 3 sec max.

**Photocoupler  
LTV-314N series**

**10. NAMING RULE**

| Part Number Options |
|---------------------|
| LTV-314NP-TA        |
| LTV-314NP-TA1       |
| LTV-314NW-TA        |
| LTV-314NW-TA1       |
| LTV314NPTA-V        |
| LTV314NPTA1-V       |
| LTV314NWT A-V       |
| LTV314NWT A1-V      |

| Definition of Suffix | Remark                                    |
|----------------------|---|
| "314N"               | LiteOn model name                         |
| "P"                  | clearance distance 7mm typical            |
| "W"                  | clearance distance 8mm typical            |
| "TA"                 | Pin 1 location at lower right of the tape |
| "TA1"                | Pin 1 location at upper left of the tape  |
| "V"                  | VDE approved option                       |

**11. Notes**

- LiteOn is continually improving the quality, reliability, function or design and LiteOn reserves the right to make changes without further notices.
- The products shown in this publication are designed for the general use in electronic applications such as office automation equipment, communications devices, audio/visual equipment, electrical application and instrumentation.
- For equipment/devices where high reliability or safety is required, such as space applications, nuclear power control equipment, medical equipment, etc, please contact our sales representatives.
- When requiring a device for any "specific" application, please contact our sales in advance.
- If there are any questions about the contents of this publication, please contact us at your convenience.
- The contents described herein are subject to change without prior notice.
- Immerge unit's body in solder paste is not recommended.