

EVALUATION KIT
AVAILABLE

Simple SOT23 Boost Controllers

MAX1522/MAX1523/MAX1524

General Description

The MAX1522/MAX1523/MAX1524 are simple, compact boost controllers designed for a wide range of DC-DC conversion topologies, including step-up, SEPIC, and flyback applications. They are for applications where extremely low cost and small size are top priorities. These devices are designed specifically to provide a simple application circuit and minimize the size and number of external components, making them ideal for PDAs, digital cameras, and other low-cost consumer electronics applications.

These devices use a unique fixed on-time, minimum off-time architecture, which provides excellent efficiency over a wide-range of input/output voltage combinations and load currents. The fixed on-time is pin selectable to either 0.5 μ s (50% max duty cycle) or 3 μ s (85% max duty cycle), permitting optimization of external component size and ease of design for a wide range of output voltages.

The MAX1522/MAX1523 operate from a +2.5V to +5.5V input voltage range and are capable of generating a wide range of outputs. The MAX1524 is intended for bootstrapped operation, permitting startup with lower input voltage. All devices have internal soft-start and short-circuit protection to prevent excessive switching current during startup and under output fault conditions. The MAX1522/MAX1524 have a latched fault mode, which shuts down the controller when a short-circuit event occurs, whereas the MAX1523 reenters soft-start mode during output fault conditions. The MAX1522/MAX1523/MAX1524 are available in a space-saving 6-pin SOT23 package.

Applications

Low-Cost, High-Current,
or High-Voltage Boost
Conversion
LCD Bias Supplies
Industrial +24V and +28V
Power Supplies

Low-Cost, Multi-Output
Flyback Converters
SEPIC Converters
Low-Cost Battery-
Powered Applications

Pin Configuration

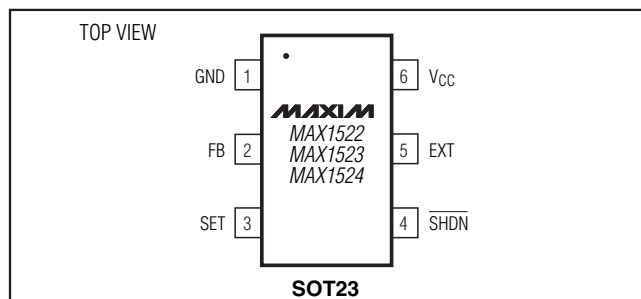

Features

- ◆ Simple, Flexible Application Circuit
- ◆ 2-Cell NiMH or Alkaline Operation (MAX1524)
- ◆ Low Quiescent Current (25 μ A typ)
- ◆ Output Fault Protection and Soft-Start
- ◆ High Efficiency Over 1000:1 I_{OUT} Range
- ◆ Pin-Selectable Maximum Duty Factor
- ◆ Micropower Shutdown Mode
- ◆ Small 6-Pin SOT23 Package
- ◆ No Current-Sense Resistor

Ordering Information

PART	TEMP. RANGE	PIN-PACKAGE	TOP MARK
MAX1522EUT-T	-40°C to +85°C	6 SOT23	AAOX
MAX1523EUT-T	-40°C to +85°C	6 SOT23	AAOY
MAX1524EUT-T	-40°C to +85°C	6 SOT23	AAOZ
MAX1522EUT+T	-40°C to +85°C	6 SOT23	+AAOX
MAX1523EUT+T	-40°C to +85°C	6 SOT23	+AAOY
MAX1524EUT+T	-40°C to +85°C	6 SOT23	+AAOZ

+Denotes a lead(Pb)-free/RoHS-compliant package.

-Denotes a package containing lead(Pb).

T = Tape and reel.

Typical Operating Circuit

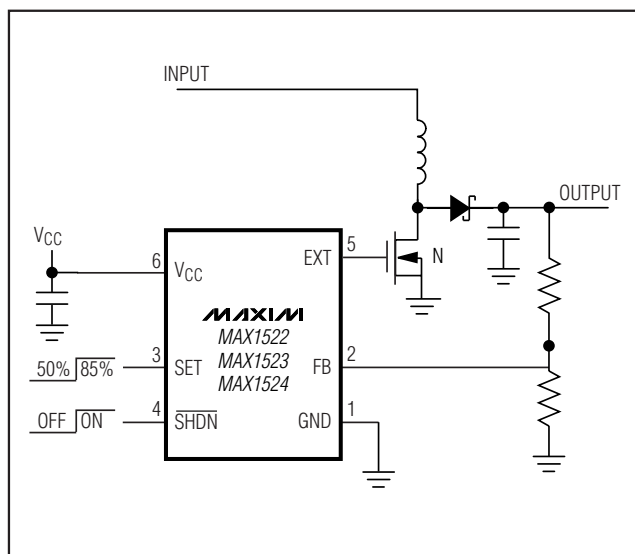

Simple SOT23 Boost Controllers

ABSOLUTE MAXIMUM RATINGS

V_{CC}, FB, $\overline{\text{SHDN}}$, SET to GND-0.3V to +6V
 EXT to GND-0.3V to (V_{CC} + 0.3V)
 Continuous Power Dissipation (T_A = +70°C)
 6-Pin SOT23 (derate 8.7mW/°C above +70°C)696mW
 Operating Temperature Range-40°C to +85°C

Junction Temperature+150°C
 Storage Temperature Range-65°C to +150°C
 Lead Temperature (soldering, 10s)+300°C
 Soldering Temperature (reflow)+260°C

Stresses beyond those listed under "Absolute Maximum Ratings" may cause permanent damage to the device. These are stress ratings only, and functional operation of the device at these or any other conditions beyond those indicated in the operational sections of the specifications is not implied. Exposure to absolute maximum rating conditions for extended periods may affect device reliability.

ELECTRICAL CHARACTERISTICS

(V_{CC} = $\overline{\text{SHDN}}$ = 3.3V, SET = GND, T_A = -40°C to +85°C, unless otherwise noted. Typical values are at T_A = +25°C.)

PARAMETER	CONDITIONS		MIN	TYP	MAX	UNITS
V _{CC} Operating Voltage Range			2.5		5.5	V
V _{CC} Minimum Startup Voltage	MAX1522/MAX1523				2.5	V
	f _{EXT} > 100kHz, MAX1524 (Note 1), bootstrap required				1.5	
Undervoltage Lockout Threshold	V _{CC} rising			2.37	2.47	V
	V _{CC} falling		2.20	2.30		
V _{CC} Supply Current	No load, nonbootstrapped			25	50	μA
V _{CC} Shutdown Current	$\overline{\text{SHDN}}$ = GND			0.001	1	μA
Fixed t _{ON} Time	V _{FB} = 1.2V	SET = GND	0.4	0.5	0.6	μs
		SET = V _{CC}	2.4	3.0	3.6	
Minimum t _{OFF} Time	V _{FB} > 0.675V			0.5		μs
	V _{FB} < 0.525V			1.0		
Maximum Duty Factor	SET = GND		45	50	55	%
	SET = V _{CC}		80	85	90	
FB Regulation Threshold (Note 2)	V _{CC} = +2.5V to +5.5V		1.23	1.25	1.27	V
FB Undervoltage Fault Threshold (Note 2)	FB falling		525	575	625	mV
FB Input Bias Current	V _{FB} = 1.3V			6	50	nA
EXT Resistance	I _{EXT} = 20mA	EXT high		2	4	Ω
		EXT low		1.5	3	
Soft-Start Ramp Time			2.2	3.2	4.2	ms
Logic Input High	V _{CC} = +2.5V to +5.5V, SET, $\overline{\text{SHDN}}$		1.6			V
Logic Input Low	V _{CC} = +2.5V to +5.5V, SET, $\overline{\text{SHDN}}$				0.4	V
Logic Input Leakage Current	SET, $\overline{\text{SHDN}}$ = V _{CC} or GND		-1		+1	μA

Note 1: Actual startup voltage is dependent on the external MOSFET's V_{GS(TH)}.

Note 2: Specification applies after soft-start mode is completed.

Simple SOT23 Boost Controllers

Typical Operating Characteristics

($T_A = +25^\circ\text{C}$, unless otherwise noted.)

MAX1522/MAX1523/MAX1524

EFFICIENCY vs. LOAD CURRENT (DESIGN EXAMPLE 1)

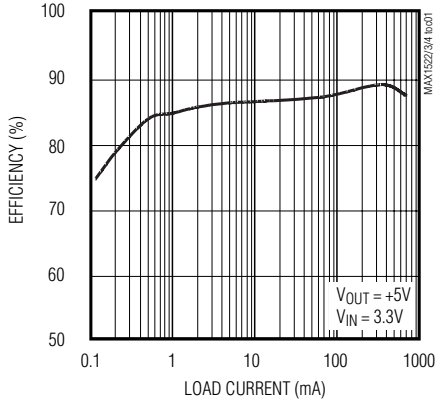

EFFICIENCY vs. LOAD CURRENT (DESIGN EXAMPLE 2)

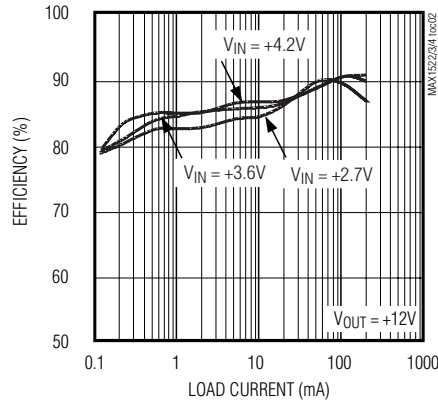

EFFICIENCY vs. LOAD CURRENT (DESIGN EXAMPLE 3)

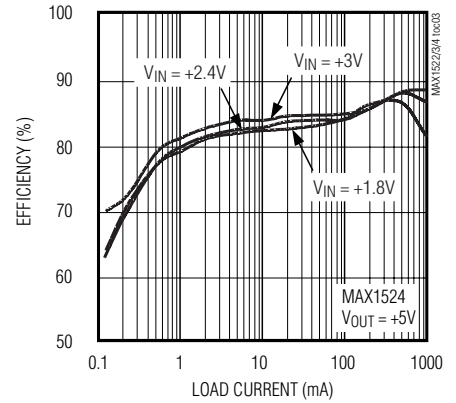

EFFICIENCY vs. LOAD CURRENT (DESIGN EXAMPLE 4)

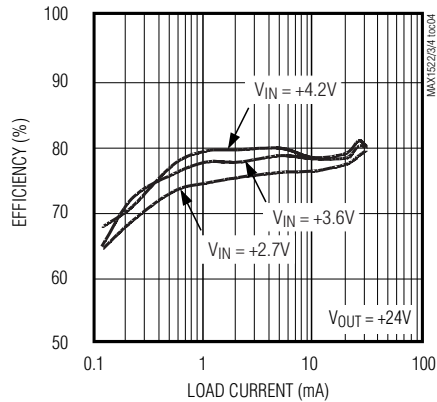

EFFICIENCY vs. LOAD CURRENT (DESIGN EXAMPLE 5)

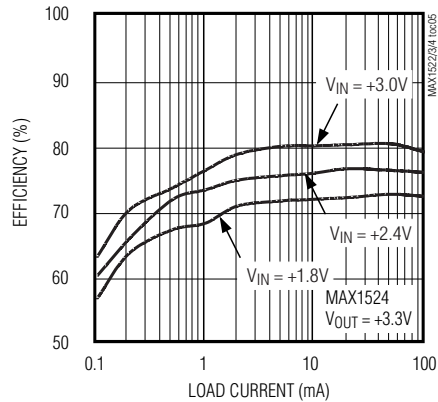

STARTUP INPUT VOLTAGE vs. OUTPUT CURRENT

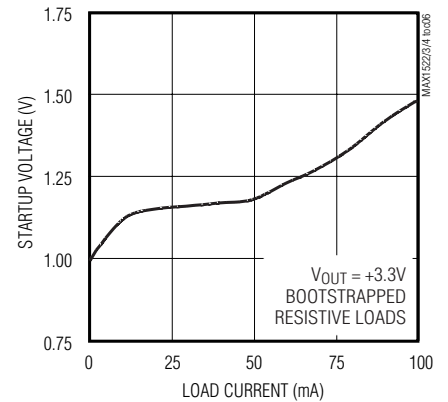

NO-LOAD INPUT CURRENT vs. INPUT VOLTAGE

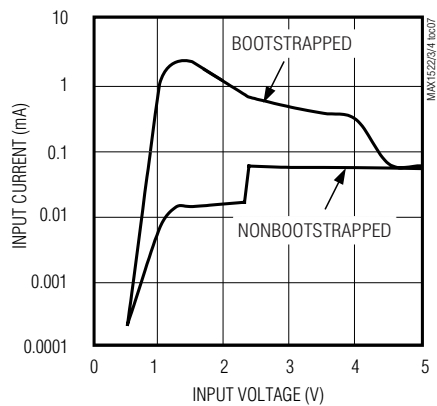

SWITCHING WAVEFORM (CONTINUOUS CONDUCTION)

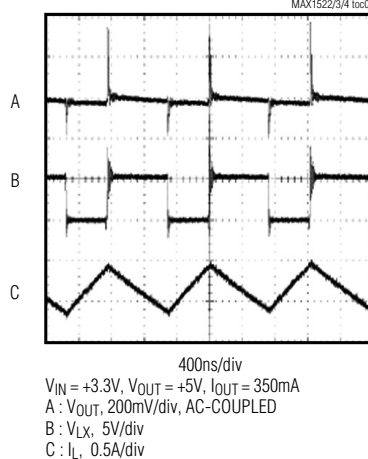

SWITCHING WAVEFORM (DISCONTINUOUS CONDUCTION)

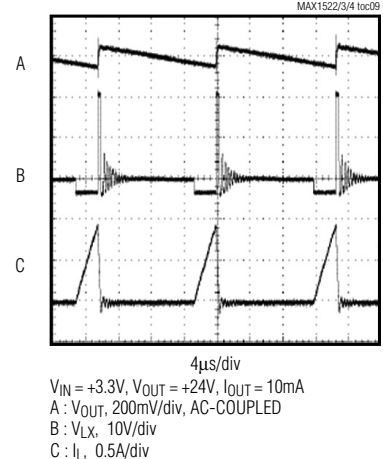

Simple SOT23 Boost Controllers

Typical Operating Characteristics (continued)

($T_A = +25^\circ\text{C}$, unless otherwise noted.)

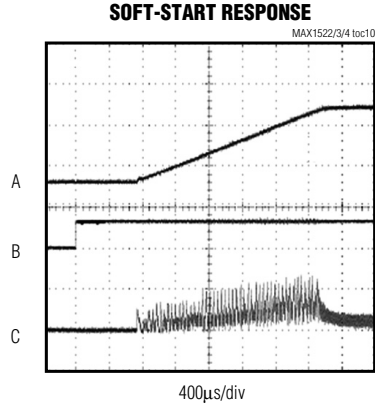

200Ω RESISTIVE LOAD
A : V_{OUT} , 5V/div
B : V_{SHDN} , 5V/div
C : I_L , 1A/div

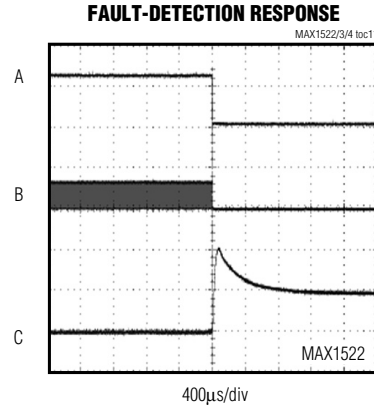

A : V_{OUT} , 10V/div
B : V_{EXT} , 5V/div
C : I_L , 5A/div

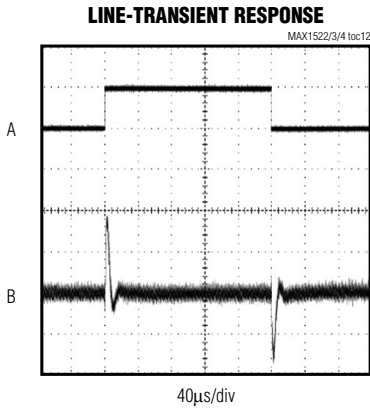

$V_{IN} = +3.5\text{V TO } +4.0\text{V}$, $V_{OUT} = +12\text{V}$, $I_{OUT} = 60\text{mA}$
A : V_{IN} , 500mV/div, AC-COUPLED
B : V_{OUT} , 10mV/div, AC-COUPLED

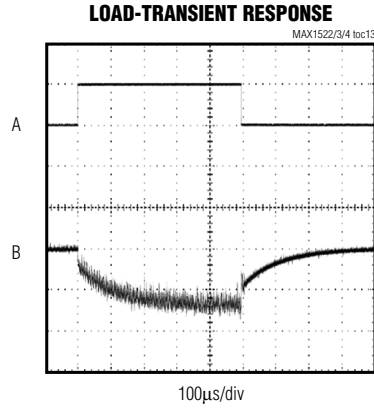

$V_{IN} = +3.3\text{V}$, $V_{OUT} = +12\text{V}$, $I_{OUT} = 30\text{mA TO } 120\text{mA}$
A : I_{OUT} , 100mA/div
B : V_{OUT} , 100mV/div, AC-COUPLED

Simple SOT23 Boost Controllers

Pin Description

PIN	NAME	FUNCTION
1	GND	Ground
2	FB	Feedback Input. Connect FB to external resistive voltage-divider. FB regulates to 1.25V.
3	SET	On-Time Control. Connect SET to V_{CC} to set the fixed 3 μ s on-time (85% duty cycle). Connect SET to GND to set the fixed 0.5 μ s on-time (50% duty cycle). See <i>On-Time SET Input</i> section for more information.
4	$\overline{\text{SHDN}}$	Shutdown Control Input. Drive $\overline{\text{SHDN}}$ high for normal operation. Drive $\overline{\text{SHDN}}$ low for low-power shutdown mode. Driving $\overline{\text{SHDN}}$ low clears the fault latch of the MAX1522 and MAX1524.
5	EXT	External MOSFET Drive. EXT drives the gate of an external NMOS power FET and swings from V_{CC} to GND.
6	V_{CC}	Supply Voltage to the IC. Bypass V_{CC} to GND with a 0.1 μ F capacitor. Connect V_{CC} to a +2.5V to +5.5V supply, which may come from V_{IN} (nonbootstrapped) or V_{OUT} (bootstrapped) or from the output of another regulator. For bootstrapped operation, connect V_{CC} to the output through a series 10 Ω resistor.

Detailed Description

The MAX1522/MAX1523/MAX1524 are simple, compact boost controllers designed for a wide range of DC-DC conversion topologies including step-up, SEPIC, and flyback applications. These devices are designed specifically to provide a simple application circuit with a minimum of external components and are ideal for PDAs, digital cameras, and other low-cost consumer electronics applications.

These devices use a unique fixed on-time, minimum off-time architecture, which provides excellent efficiency over a wide range of input/output voltage combinations and load currents. The fixed on-time is pin selectable to either 0.5 μ s or 3 μ s, permitting optimization of external component size and ease of design for a wide range of output voltages.

Control Scheme

The MAX1522/MAX1523/MAX1524 feature a unique fixed on-time, minimum off-time architecture, which provides excellent efficiency over a wide range of input/output voltage combinations. The fixed on-time is pin selectable to either 0.5 μ s or 3 μ s for a maximum duty factor of either 45% or 80%, respectively. An inductor charging cycle is initiated by driving EXT high, turning on the external MOSFET. The MOSFET remains on for the fixed on-time, after which EXT turns off the MOSFET. EXT stays low for at least the minimum off-

time, and another cycle begins when FB drops below its 1.25V regulation point.

Bootstrapped vs. Nonbootstrapped

The V_{CC} supply voltage range of the MAX1522/MAX1523/MAX1524 is +2.5V to +5.5V. The supply for V_{CC} can come from the input voltage (nonbootstrapped), the output voltage (bootstrapped), or an independent regulator.

The MAX1522/MAX1523 are usually utilized in a non-bootstrapped configuration, allowing for high or low output voltage operation. However, when both the input and output voltages fall within the +2.5V to +5.5V range, the MAX1522/MAX1523 may be operated in nonbootstrapped or bootstrapped mode. Bootstrapped mode provides higher gate-drive voltage to the MOSFET switch, reducing I^2R losses in the switch, but will also increase the V_{CC} supply current to charge and discharge the gate. Depending upon the MOSFET selected, there may be minor variation in efficiency vs. load vs. input voltage when comparing bootstrapped and nonbootstrapped configurations.

The MAX1524 is always utilized in bootstrapped configuration for applications where the input voltage range extends down below 2.5V and the output voltage is between 2.5V and 5.5V. V_{CC} is connected to the output (through a 10 Ω series resistor) and receives startup voltage through the DC current path from the input through the inductor, diode, and 10 Ω resistor. The MAX1524 features a low-voltage startup oscillator that

Simple SOT23 Boost Controllers

guarantees startup with input voltages down to 1.5V at V_{CC} . The startup oscillator has a fixed 25% duty cycle and will toggle the MOSFET gate and begin boosting the output voltage. Once the output voltage exceeds the UVLO threshold, the normal control circuitry is used and the startup oscillator is disabled. However, N-channel MOSFETs are rarely specified for guaranteed $R_{DS(ON)}$ with V_{GS} below 2.5V; therefore, guaranteed startup down to 1.5V input will be limited by the MOSFET specifications. Nevertheless, the MAX1524 bootstrapped circuit on the MAX1524 EV kit typically starts up with input voltage below 1V and no load.

The MAX1522/MAX1523 may also be utilized by connecting V_{CC} to the output of an independent voltage regulator between 2.5V and 5.5V to allow operation with any combination of low or high input and output voltages. In this case, the independent regulator must supply enough current to satisfy the I_{GATE} current as calculated in the *Power MOSFET Selection* section when considering the maximum switching frequency as calculated in the CCM or DCM design procedure.

On-Time SET Input

The MAX1522/MAX1523/MAX1524 feature pin-selectable fixed on-time control, allowing their operation to be optimized for various input/output voltage combinations. Connect SET to V_{CC} for the 3 μ s fixed on-time. Connect SET to GND for the 0.5 μ s fixed on-time.

The 3 μ s on-time setting (SET = V_{CC}) permits higher than 80% guaranteed maximum duty factor, providing improved efficiency in applications with higher step-up ratios (such as 3.3V boosting to 12V). This setting is recommended for higher step-up ratio applications.

The 0.5 μ s on-time setting (SET = GND) permits higher frequency operation, minimizing the size of the external inductor and capacitors. The maximum duty factor is limited to 45% guaranteed, making this setting suitable for lower step-up ratios such as 3.3V to 5V converters.

Soft-Start

The MAX1522/MAX1523/MAX1524 have a unique soft-start mode that reduces inductor current during startup, reducing battery, input capacitor, MOSFET, and inductor stresses. The soft-start period is fixed at 3.2ms and requires no external components.

Fault Detection

Once the soft-start period has expired, if the output voltage falls to, or is less than, 50% of its regulation value, a fault is detected. Under this condition, the MAX1522 disables the regulator until either SHDN is toggled low or power is removed and reapplied, after which it attempts to power up again in soft-start. For the

MAX1523, the fault condition is not latched, and soft-start is repetitively reinitiated until a valid output voltage is realized. The MAX1524 has a latched fault detection, but when bootstrapped, the latch will be cleared when V_{CC} falls below 2.37V.

Shutdown Mode

Drive \overline{SHDN} to GND to place the MAX1522/MAX1523/MAX1524 in shutdown mode. In shutdown, the internal reference and control circuitry turn off, EXT is driven to GND, the supply current is reduced to less than 1 μ A, and the output drops to one diode drop below the input voltage. Connect \overline{SHDN} to V_{CC} for normal operation. When exiting shutdown mode, the 3.2ms soft-start is always initiated.

Undervoltage Lockout

The MAX1522/MAX1523 have undervoltage lockout (UVLO) circuitry, which prevents circuit operation and MOSFET switching when V_{CC} is less than the UVLO threshold (2.37V typ). The UVLO comparator has 70mV of hysteresis to eliminate chatter due to V_{CC} input impedance.

Applications Information

Setting the Output Voltage

The output voltage is set by connecting FB to a resistive voltage-divider between the output and GND (Figures 1 and 2). Select feedback resistor R2 in the 30k Ω to 100k Ω range. R1 is then given by:

$$R1 = R2 \left(\frac{V_{OUT}}{V_{FB}} - 1 \right)$$

where $V_{FB} = 1.25V$.

Design Procedure

Continuous vs. Discontinuous Conduction

A switching regulator is operating in continuous conduction mode (CCM) when the inductor current is not allowed to decay to zero. This is accomplished by selecting an inductor value large enough that the inductor ripple current becomes less than one half of the input current. The advantage of this mode is that peak current is lower, reducing I^2R losses and output ripple.

In general, the best transient performance and most of the ripple reduction and efficiency increase of CCM are realized when the inductance is large enough to reduce the ripple current to 30% of the input current at maximum load. It is important to note that CCM circuits operate in discontinuous conduction mode (DCM)

Simple SOT23 Boost Controllers

under light loads. The selection of 30% ripple current causes this to happen at loads less than approximately 1/6th of maximum load.

There are two common reasons not to run in CCM:

1) **High output voltage.** In this case, the output-to-input voltage ratio exceeds the level obtainable by the MAX1522/MAX1523/MAX1524s' maximum duty factor. Calculate the application's maximum duty cycle using the equation in the *Calculate the Maximum Duty Cycle* section. If this number exceeds 80%, you will have to design for DCM.

2) **Small output current.** If the maximum output current is very small, the inductor required for CCM may be disproportionately large and expensive. Since I^2R losses are not a concern, it may make sense to use a smaller inductor and run in DCM. This typically occurs when the load current times the output-to-input voltage ratio drops below a few hundred milliamps, although this also depends on the external components.

Calculate the Maximum Duty Cycle

The maximum duty cycle of the application is given by:

$$\text{DutyCycle}_{(\text{MAX})} = \frac{V_{\text{OUT}} + V_{\text{D}} - V_{\text{IN}(\text{MIN})}}{V_{\text{OUT}} + V_{\text{D}}} \times 100\%$$

where V_{D} is the forward voltage drop of the Schottky diode (about 0.5V).

Design Procedure for CCM

On-Time Selection

For CCM to occur, the MAX1522/MAX1523/MAX1524 must be able to exceed the application's maximum duty cycle. For applications up to 45% duty cycle, con-

nect SET to GND for 0.5 μ s on-time to get fast switching and a smaller inductor. For applications up to 80% duty cycle, it is necessary to connect SET to V_{CC} for 3.0 μ s on-time. For applications greater than 80% duty cycle, CCM operation is not guaranteed; see the *Design Procedure for DCM* section.

Switching Frequency

A benefit of CCM is that the switching frequency remains high as the load is reduced, whereas in DCM the switching frequency varies directly with load. This is important in applications where switching noise needs to stay above the audio band. The medium- and heavy-load switching frequency in CCM circuits is given by:

$$f_{\text{SWITCHING}} = \frac{1}{t_{\text{ON}}} \times \frac{V_{\text{OUT}} + V_{\text{D}} - V_{\text{IN}}}{V_{\text{OUT}} + V_{\text{D}}}$$

Note that $f_{\text{SWITCHING}}$ is not a function of load and varies primarily with input voltage. However, when the load is reduced, a CCM circuit drops into DCM, and the frequency becomes load dependent:

$$f_{\text{SWITCHING}(\text{LIGHT-LOAD})} \approx \frac{1}{t_{\text{ON}}} \times \frac{V_{\text{OUT}} + V_{\text{D}} - V_{\text{IN}}}{V_{\text{OUT}} + V_{\text{D}}} \times \frac{I_{\text{LOAD}}}{0.18 \times I_{\text{LOAD}(\text{MAX})}}$$

Calculate the Peak Inductor Current

For CCM, the peak inductor current is given by:

$$I_{\text{PEAK}} = 1.15 \times \frac{V_{\text{OUT}} + V_{\text{D}}}{V_{\text{IN}(\text{MIN})}} \times I_{\text{LOAD}(\text{MAX})}$$

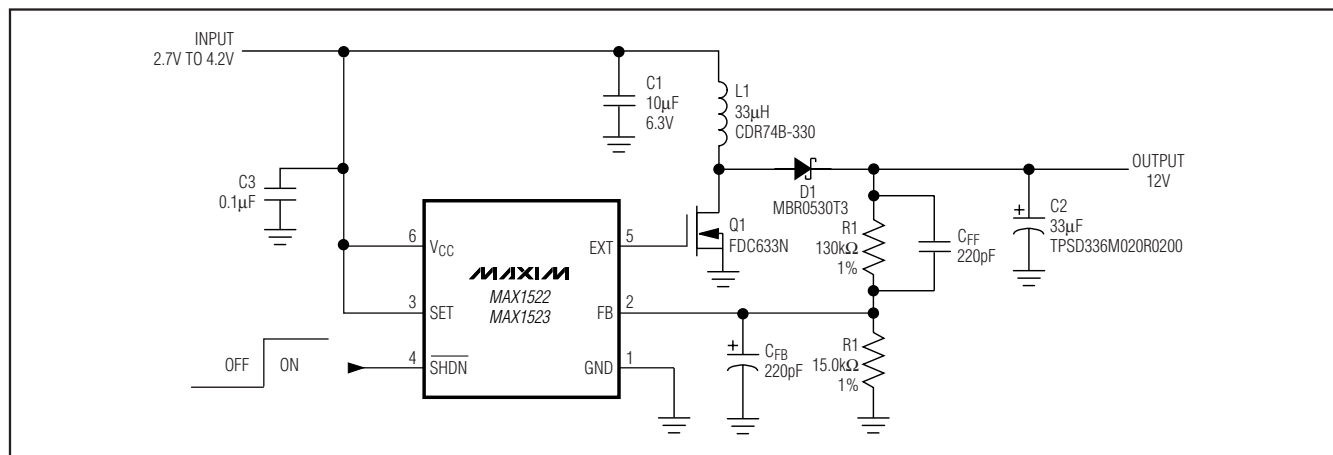

Figure 1. MAX1522/MAX1523 Standard Operating Circuit

Simple SOT23 Boost Controllers

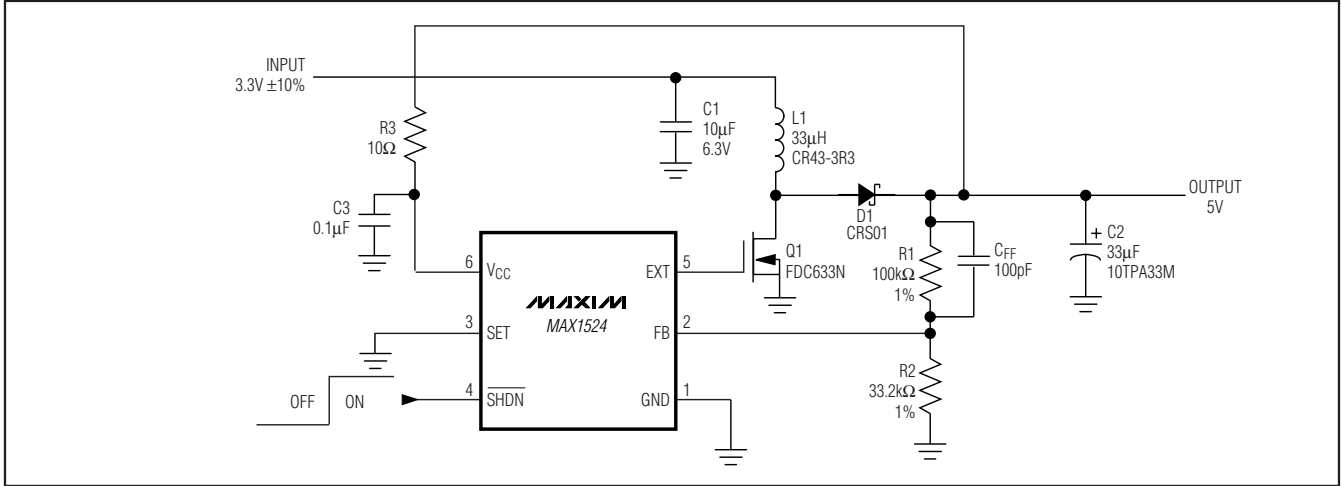

Figure 2. MAX1524 Standard Operating Circuit

Inductor Selection

For CCM, the ideal inductor value is given by:

$$L_{IDEAL} = \frac{V_{IN(TYP)} \times t_{ON(TYP)}}{0.3 \times I_{PEAK}}$$

If L_{IDEAL} is not a standard value, choose the next-closest value, either higher or lower. Nominal values within 50% are acceptable. Values lower than ideal will have slightly higher peak inductor current; values greater than ideal will have slightly lower peak inductor current.

Due to the MAX1522/MAX1523/MAX1524s' high switching frequencies, inductors with a ferrite core or equivalent are recommended. Powdered iron cores are **not** recommended due to their high losses at frequencies over 50kHz.

The saturation rating of the selected inductor should meet or exceed the calculated value for I_{PEAK} , although most coil types can be operated up to 20% over their saturation rating without difficulty. In addition to the saturation criteria, the inductor should have as low a series resistance as possible. The power loss in the inductor resistance is approximately given by:

$$P_{LR} \cong \left(\frac{I_{LOAD} \times (V_{OUT} + V_D)}{V_{IN}} \right)^2 \times R_L$$

Output Capacitor Selection

In CCM, to provide stable operation and to control output sag to less than 0.5%, the output bulk capacitance should be greater than:

$$C_{OUT(MIN)} = \frac{I_{LOAD(MAX)} \times t_{ON}}{0.005 \times V_{OUT}}$$

To properly control peak inductor current during the 3.2ms soft-start, the output bulk capacitance should be less than:

$$C_{OUT(MAX)} = \frac{I_{LOAD(MAX)} \times t_{SS}}{V_{OUT}}$$

where $t_{SS} = 3.2ms$.

Because the MAX1522/MAX1523/MAX1524 are voltage-mode devices (and therefore do not require an expensive current-sense resistor), cycle-to-cycle stability is obtained from the output capacitor's equivalent series resistance (ESR). Choose an output capacitor with actual ESR greater than:

$$ESR_{COUT} > \frac{L}{C_{OUT}} \times \frac{I_{LOAD(MAX)}}{V_{IN(MIN)}}$$

Additionally, to control peak inductor current during soft-start, the output capacitor's ESR should be greater than:

$$ESR_{COUT} > 60 \times 10^{-3} \times \frac{V_{FB}}{I_{PEAK}}$$

Usually, this prevents the use of ceramic capacitors in CCM applications. Alternatives include tantalum, electrolytic, and organic types such as Sanyo's POSCAP. The output capacitor must also be rated to withstand the output voltage and the output ripple current, which is equivalent to I_{PEAK} . Since output ripple in boost DC-DC designs is dominated by capacitor ESR, a capaci-

Simple SOT23 Boost Controllers

tance value two or three times larger than $C_{OUT(MIN)}$ is typically needed. Output ripple due to ESR is:

$$V_{RIPPLE(ESR)} \cong 0.3 \times I_{PEAK} \times ESR_{COUT}$$

at light and medium loads, and three times as great at peak load.

Continue the CCM design procedure by going to the *Optional Feed-Forward Capacitor Selection* section.

Design Procedure for DCM

On-Time Selection

The MAX1522/MAX1523/MAX1524 may operate in DCM at any duty cycle as required by the application's input and output voltages. However, best performance is achieved when the maximum duty cycle of the application is similar to the MAX1522/MAX1523/MAX1524s' maximum duty factor as set using the SET input. Connect SET to GND for applications with maximum duty cycles less than 67%. Connect SET to VCC for applications with maximum duty cycles between 67% and 99%.

Inductor Selection

For DCM, the ideal inductor value is given by:

$$L_{IDEAL} = \frac{(V_{IN(MIN)})^2 \times t_{ON(MIN)}}{3 \times (V_{OUT} + V_D) \times I_{LOAD(MAX)}}$$

If L_{IDEAL} is not a standard value, choose the next lower nominal value. The above formula already includes a factor for $\pm 30\%$ inductor tolerance. Values higher than ideal may not supply the maximum load when the input voltage is low, while values much lower than ideal will have poorer efficiency.

Calculate the Peak Inductor Current

For DCM, the peak inductor current is given by:

$$I_{PEAK} = \frac{V_{IN(MAX)} \times t_{ON(MAX)}}{L}$$

The saturation rating of the selected inductor should meet or exceed the calculated value for I_{PEAK} , although most coil types can be operated up to 20% over their saturation rating without difficulty. In addition to the saturation criteria, the inductor should have as low a series resistance as possible. The power loss in the inductor resistance is approximately given by:

$$P_{LR} \cong \frac{2}{3} \left(I_{PEAK} \times I_{OUT} \times \left(\frac{V_{OUT} + V_D}{V_{IN}} \right) \right) R_L$$

Due to the MAX1522/MAX1523/MAX1524s' high switching frequencies, inductors with a ferrite core or equivalent are recommended. Powdered iron cores are **not** recommended due to their high losses at frequencies over 50kHz.

Switching Frequency

In DCM, the switching frequency is proportional to the load current and is approximately given by:

$$f_{SWITCHING} \approx 0.7 I_{OUT} \times \frac{(V_{OUT} + V_D - V_{IN})}{t_{ON}^2 \times V_{IN}^2} \times 2L$$

Note that $f_{SWITCHING}$ is a function of load and input voltage.

Output Capacitor Selection

In DCM, the MAX1522/MAX1523/MAX1524 may use either a ceramic output capacitor (with very low ESR) or other capacitors, such as tantalum or organic, with higher ESR. For less than 2% output ripple, the minimum value for ceramic output capacitors should be greater than:

$$C_{OUT(MIN)} = \frac{1}{2L} \times \frac{t_{ON}^2 \times V_{IN}^2}{(V_{OUT} + V_D - V_{IN})} \times \frac{1}{0.02 V_{OUT}}$$

To control inductor current during soft-start, the maximum value for any type of output capacitors should be less than:

$$C_{OUT(MAX)} = \frac{I_{LOAD(MAX)} \times t_{SS}}{V_{OUT}}$$

where $t_{SS} = 3.2\text{ms}$.

The capacitor should be chosen to provide an output ripple between 25mV minimum and 2% of V_{OUT} maximum. The output ripple due to capacitance ripple and ESR ripple can be approximated by:

$$V_{RIPPLE(COUT+ESR)} \cong \left[\frac{1}{2L} \times \frac{t_{ON}^2 \times V_{IN}^2}{(V_{OUT} + V_D - V_{IN})} \times \frac{1}{C_{OUT}} \right] + \left[\frac{V_{IN} \times t_{ON}}{L} \times ESR_{COUT} \right]$$

For output ripple close to 2% of V_{OUT} , the optional feed-forward capacitor may not be required. For lower output ripple, a feed-forward capacitor is necessary for stability and to control inductor current during soft-start.

Simple SOT23 Boost Controllers

Optional Feed-Forward Capacitor Selection

For proper control of peak inductor current during soft-start and for stable switching, the ripple at FB should be greater than 25mV. Without a feed-forward capacitor connected between the output and FB, the output's ripple must be at least 2% of V_{OUT} in order to meet this requirement. Alternatively, if a low-ESR output capacitor is chosen to obtain small output ripple, then a feed-forward capacitor should be used, and the output ripple may be as low as 25mV. The approximate value of the feed-forward capacitor is given by:

$$C_{FF} \cong 3 \times 10^{-6} \left(\frac{1}{R_1} + \frac{1}{R_2} \right)$$

Do not use a feed-forward capacitor that is much larger than this because line-transient performance will degrade. Do not use a feed-forward capacitor at all if the output ripple is large enough without it to provide stable switching because load regulation will degrade.

Optional Feedback Capacitor Selection

When using a feed-forward capacitor, it is possible to achieve too much ripple at FB. The symptoms of this include excessive line and load regulation and possibly high output ripple at light loads in the form of pulse groupings or "bursts." Fortunately, this is easy to correct by either choosing a lower-ESR output capacitor or by adding a feedback capacitor between FB and ground. This feedback capacitor (C_{FB}), along with the feed-forward capacitor, form an AC-coupled ripple voltage-divider from the output to FB:

$$\text{Ripple}_{FB} = \text{Ripple}_{OUTPUT} \times \left(\frac{C_{FF}}{C_{FB} + C_{FF}} \right)$$

It is relatively simple to determine a good value for C_{FB} experimentally. Start with $C_{FB} = C_{FF}$ to cut the FB ripple in half; then increase or decrease C_{FB} as needed. The ideal ripple at FB is from 25mV to 40mV, which will provide stable switching, low output ripple at light and medium loads, and reasonable line and load regulation. Never use a feedback capacitor without also using a feed-forward capacitor.

Input Capacitor Selection

The input capacitor (C_{IN}) in boost designs reduces the current peaks drawn from the input supply, increases efficiency, and reduces noise injection. The source impedance of the input supply largely determines the value of C_{IN} . High source impedance requires high input capacitance, particularly as the input voltage

falls. Since step-up DC-DC converters act as "constant-power" loads to their input supply, input current rises as input voltage falls. Consequently, in low-input-voltage designs, increasing C_{IN} and/or lowering its ESR can add as many as five percentage points to conversion efficiency. A good starting point is to use the same capacitance value for C_{IN} as for C_{OUT} . The input capacitor must also meet the ripple current requirement imposed by the switching currents, which is about 30% of I_{PEAK} in CCM designs and 100% of I_{PEAK} in DCM designs.

In addition to the bulk input capacitor, a ceramic 0.1 μ F bypass capacitor at V_{CC} is recommended. This capacitor should be located as close to V_{CC} and GND as possible. In bootstrapped configuration, it is recommended to isolate the bypass capacitor from the output capacitor with a series 10 Ω resistor between the output and V_{CC} .

Power MOSFET Selection

The MAX1522/MAX1523/MAX1524 drive a wide variety of N-channel power MOSFETs (NFETs). Since the output gate drive is limited to V_{CC} , a logic-level NFET is required. Best performance, especially when V_{CC} is less than 4.5V, is achieved with low-threshold NFETs that specify on-resistance with a gate-source voltage (V_{GS}) of 2.7V or less. When selecting an NFET, key parameters include:

- 1) Total gate charge (Q_g)
- 2) Reverse transfer capacitance or charge (C_{RSS})
- 3) On-resistance ($R_{DS(ON)}$)
- 4) Maximum drain-to-source voltage ($V_{DS(MAX)}$)
- 5) Minimum threshold voltage ($V_{TH(MIN)}$)

At high switching rates, dynamic characteristics (parameters 1 and 2 above) that predict switching losses may have more impact on efficiency than $R_{DS(ON)}$, which predicts I^2R losses. Q_g includes all capacitances associated with charging the gate. In addition, this parameter helps predict the current needed to drive the gate when switching at high frequency. The continuous V_{CC} current due to gate drive is:

$$I_{GATE} = Q_g \times f_{SWITCHING}$$

Use the FET manufacturer's typical value for Q_g (see manufacturer's graph of Q_g vs. V_{GS}) in the above equation since a maximum value (if supplied) is usually too conservative to be of any use in estimating I_{GATE} .

Simple SOT23 Boost Controllers

Diode Selection

The MAX1522/MAX1523/MAX1524s' high switching frequency demands a high-speed rectifier. Schottky diodes are recommended for most applications because of their fast recovery time and low forward voltage. Ensure that the diode's current rating is adequate to withstand the diode's RMS current:

$$I_{\text{DIODE(RMS)}} < \sqrt{I_{\text{OUT}} \times I_{\text{PEAK}}}$$

Also, the diode reverse breakdown voltage must exceed V_{OUT} . For high output voltages (50V or above), Schottky diodes may not be practical because of this voltage requirement. In these cases, use a high-speed silicon rectifier with adequate reverse voltage. Another consideration for high input voltages is reverse leakage of the diode. This should be considered using the manufacturer's specification due to its direct influence on system efficiency.

Layout Considerations

High switching frequencies and large peak currents make PC board layout a very important part of design. Good design minimizes excessive EMI on the feedback

paths and voltage gradients in the ground plane, both of which can result in instability or regulation errors. Connect the inductor, input filter capacitor, and output filter capacitor as close together as possible, and keep their traces short, direct, and wide. Connect their ground pins at a single common node in a star-ground configuration. The external voltage-feedback network should be very close to the FB pin, within 0.2in (5mm). Keep noisy traces (such as the trace from the junction of the inductor and MOSFET) away from the voltage-feedback network; also keep them separate, using grounded copper. The MAX1522/MAX1523/ MAX1524 evaluation kit manual shows an example PC board layout and routing scheme.

Generating Resistance with PC Board Traces

If the output capacitor's ESR is too low for proper regulation, it can be increased artificially directly on the PC board. For example, an additional 50m Ω of ESR added to the output capacitor provides best regulation. The resistivity of a 10mil trace using 1oz copper is about 50m Ω per inch. Therefore, a 10mil trace 1in long generates the required resistance.

Simple SOT23 Boost Controllers

Table 1. Design Examples Using CCM

PARAMETER	EXAMPLE 1	EXAMPLE 2	EXAMPLE 3
V _{IN}	3.3V ±10%	2.7V to 4.2V	1.8V to 3.0V
V _{OUT}	5V	12V	5V
I _{OUT(MAX)}	700mA	200mA	1.0A
R1, R2	274kΩ, 90.9kΩ	866kΩ, 100kΩ	274kΩ, 90.9kΩ
Duty Cycle (max)	45.5%	78.4%	67.3%
t _{ON}	0.5μs (SET = GND)	3μs (SET = V _{CC})	3μs (SET = V _{CC})
f _{SWITCHING}	691kHz to 909kHz when I _{OUT} > 120mA	221kHz to 261kHz when I _{OUT} > 35mA	152kHz to 224kHz when I _{OUT} > 167mA
I _{PEAK}	1.48A	1.06A	3.51A
L _{IDEAL}	3.73μH	33.8μH	6.83μH
L _{ACTUAL}	Sumida CR43-3R3 3.3μH, 86mΩ, 1.44A	Sumida CDR74B-330 33μH, 180mΩ, 0.97A	Sumida CDRH125-5R8 5.8μH, 17mΩ, 4.4A
PL _R	29mW at I _{OUT} = 350mA	22mW at I _{OUT} = 100mA	22mW at I _{OUT} = 500mA
C _{OUT(MIN)} to C _{OUT(MAX)}	14μF to 448μF	10μF to 53μF	120μF to 640μF
C _{OUT}	33μF	33μF	150μF
ESR _{COUT(MIN)}	23mΩ for stability, 51mΩ for soft-start	74mΩ for stability, 70mΩ for soft-start	21mΩ for stability, 21mΩ for soft-start
C _{OUT(ACTUAL)}	Sanyo POSCAP 10TPA33M 33μF, 10V, 60mΩ, 100mΩ max	AVX TPSD336M020R0200 33μF, 20V, 150mΩ, 200mΩ max	Sanyo POSCAP 6TPB150M 150μF, 6.3V, 40mΩ, 55mΩ max
V _{RIPPLE(ESR)}	27mV _{p-p} at light loads, 81mV _{p-p} at full load	48mV _{p-p} at light loads, 144mV _{p-p} at full load	42mV _{p-p} at light loads, 126mV _{p-p} at full load
C _{FF}	100pF	100pF	100pF
C _{FB}	100pF	330pF	220pF
C _{IN}	10μF, 6.3V ceramic	10μF, 6.3V ceramic	10μF, 6.3V ceramic
MOSFET	Fairchild FDC633N	Fairchild FDC633N	Vishay Si3446DV
Q _g	8nC at V _{gs} = 3V 12nC at V _{gs} = 5V	9nC at V _{gs} = 3.6V	10nC at V _{gs} = 5V
I _{GATE}	7.3mA nonbootstrapped, 10.9mA bootstrapped	2.4mA nonbootstrapped	2.2mA bootstrapped
I _{DIODE(RMS)}	0.96A	0.49A	1.84A
Diode	Nihon EP10QY03, 1A	Nihon EP10QY03, 1A	Nihon EC21QS03L, 2A

Simple SOT23 Boost Controllers

MAX1522/MAX1523/MAX1524

Table 2. Design Examples Using DCM

PARAMETER	EXAMPLE 4	EXAMPLE 5
V _{IN}	2.7V to 4.2V	1.8V to 3.0V
V _{OUT}	24V	3.3V
I _{OUT(MAX)}	30mA	100mA
R ₁ , R ₂	909kΩ, 49.9kΩ	150kΩ, 93.1kΩ
Duty Cycle (max)	89.0%	52.6%
t _{ON}	3μs (SET = V _{CC})	0.5μs (SET = GND)
L _{IDEAL}	11.9μH	1.14μH
L _{ACTUAL}	Sumida CDRH5D28-100 10μH, 65mΩ, 1.3A	Sumida CDRH4D18-1R0 1μH, 45mΩ, 1.72A
I _{PEAK}	1.51A	1.80A
PL _R	4.5mW at I _{OUT} = 10mA	5.7mW I _{OUT} = 50mA
f _{SWITCHING}	208kHz when I _{OUT} = 20mA	737kHz when I _{OUT} = 100mA
C _{OUT(MIN)} to C _{OUT(MAX)}	0.8μF to 2.7μF	3μF to 97μF
C _{OUT(ACTUAL)}	Taiyo Yuden GMK325BJ225K 2.2μF, X5R, 35V, 1210	Taiyo Yuden TMK316BT106ML 10μF, X7R, 6.3V, 1206
ESR _{COUT(ACTUAL)}	10mΩ	10mΩ
V _{RIPPLE(COUT+ESR)}	126mV _{p-p}	40mV _{p-p}
C _{FF}	100pF	220pF
C _{FB}	220pF	100pF optional
C _{IN}	10μF, 6.3V	10μF, 6.3V
MOSFET	Fairchild FDC633N	Vishay Si2302DS
Q _g	8nC at V _{gs} = 3V	5nC at V _{gs} = 3.3V
I _{GATE}	1.7mA nonbootstrapped	3.7mA bootstrapped
I _{DIODE(RMS)}	0.17A	0.42A
Diode	Nihon EP10QY03, 1A	Nihon EP10QY03, 1A

Table 3. Component Manufacturers

MANUFACTURER	PHONE	WEB
Coilcraft	847-639-6400	www.coilcraft.com
Fairchild	800-341-0392	www.fairchildsemi.com
International Rectifier	310-322-3331	www.irf.com
Kemet	408-986-0424	www.kemet.com
NIC Components	408-954-8470	www.niccomp.com
Panasonic	847-468-5624	www.panasonic.com
Sumida	847-956-0666	www.sumida.com
Taiyo Yuden	408-573-4150	www.t-yuden.com

Chip Information

TRANSISTOR COUNT: 1302

Package Information

For the latest package outline information and land patterns, go to www.maxim-ic.com/packages. Note that a "+", "#", or "-" in the package code indicates RoHS status only. Package drawings may show a different suffix character, but the drawing pertains to the package regardless of RoHS status.

PACKAGE TYPE	PACKAGE CODE	OUTLINE NO.	LAND PATTERN NO.
6 SOT23	U6+1	21-0058	90-0175

Simple SOT23 Boost Controllers

Revision History

REVISION NUMBER	REVISION DATE	DESCRIPTION	PAGES CHANGED
0	2/01	Initial release	—
1	8/10	Added lead-free parts and soldering temperature	1, 2

Maxim cannot assume responsibility for use of any circuitry other than circuitry entirely embodied in a Maxim product. No circuit patent licenses are implied. Maxim reserves the right to change the circuitry and specifications without notice at any time.

14 **Maxim Integrated Products, 120 San Gabriel Drive, Sunnyvale, CA 94086 408-737-7600**