

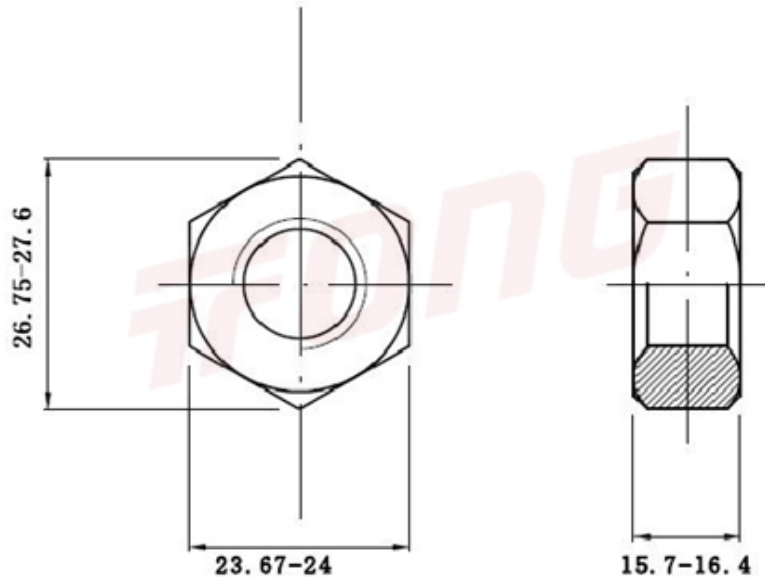

项目号 120770



\*图纸仅供参考，请以实物为准

材质	316
标准	GB6175 加厚
规格	M16-2.0
项目号	120770
品名	2型六角螺帽



项目号 120770

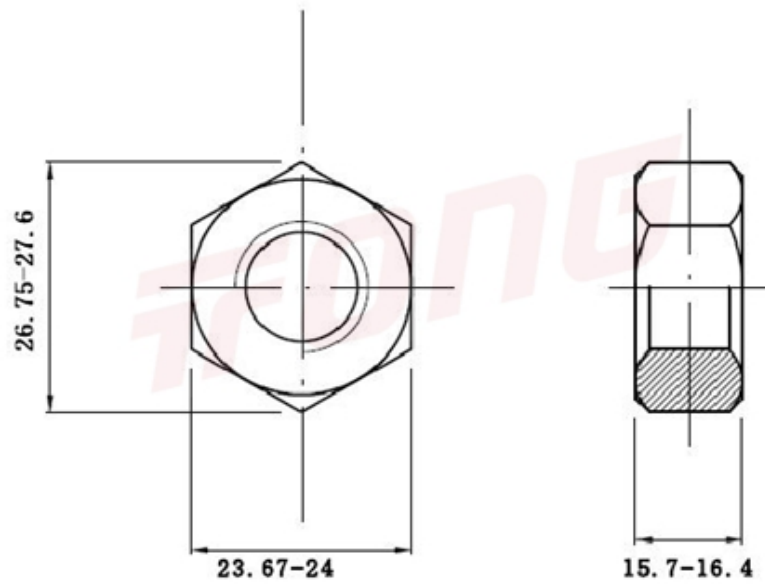

\*图纸仅供参考，请以实物为准

材质	316
标准	GB6175 加厚
规格	M16-2.0
项目号	120770
品名	2型六角螺帽