



连云港美华电子科技有限公司
Lianyungang Meihua Electronics Technology Co.,Ltd

产品规格书

DATA SHEET

Part No: MHPA3528CRGBCT
REV.1

本产品符合 ROHS 指令有关限制有害物质的环保要求.

日期 DATE	拟制 PREPARED	审核 VERIFIED	批准 APPROVED
2019-01-07	Bob		Sunny
客户签回 CUSTOMER'S APPROVAL			

电 话 Tel: 0518-83286000

传 真 Fax: 0518-83696699

邮件 E-mail: sales@lygmh.com.cn

网 址 Web: <http://www.lygmh.com.cn>

地址 ADD: 中国·江苏省连云港市灌南经济开发区北环路

North Around Road,Guannan EDA,Lianyungang City,Jiangsu Province China.



连云港美华电子科技有限公司

P/N:MHPA3528CRGBCT

LED PLCC

产品外观尺寸 PACKAGE DIMENSIONS

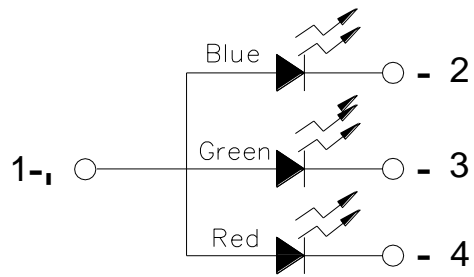
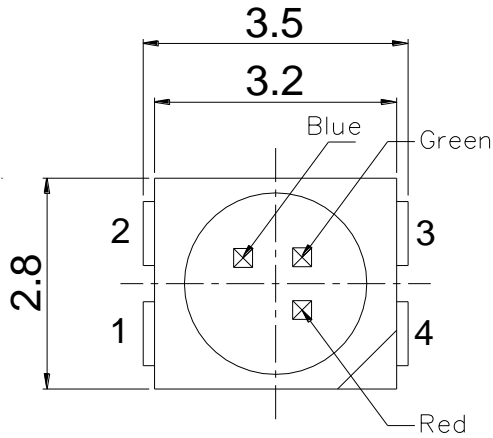

Polarity

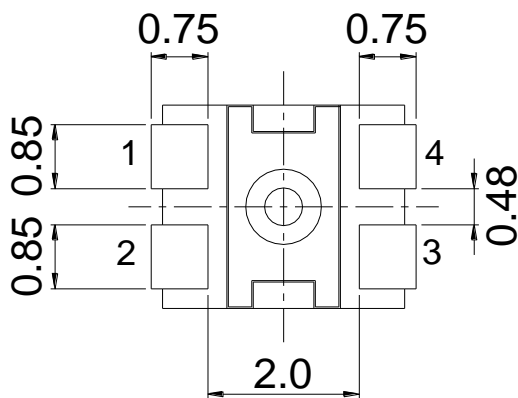
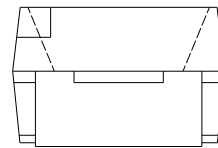
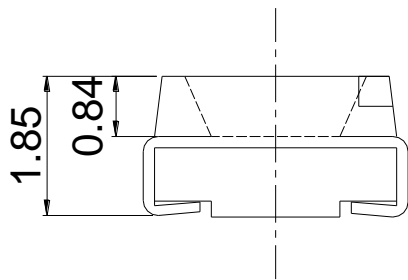

Recommended solder pad

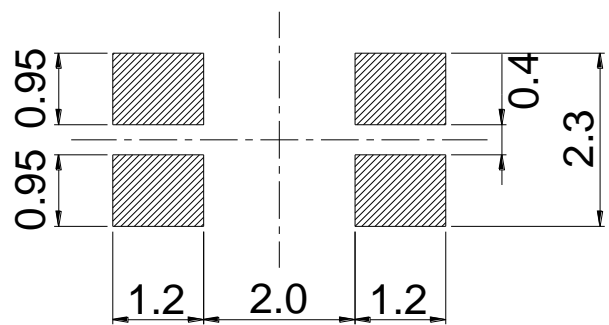

注意 NOTES :

1. 所有尺寸均为 mm(英寸)

All dimensions are in millimeters. (inches)

2. 如无特殊说明, 公差为 0.10mm(0.004")

Tolerance is $\pm 0.10\text{mm}(0.004")$ unless otherwise specified.



连云港美华电子科技有限公司

P/N:MHPA3528CRGBCT

LED PLCC

特性参数 FEATURES

- 高可靠性和高稳定性
High intensity and reliability
- 高品质、和低功耗、低成本
High quality, Low power requirement and low cost
- IC 易兼容、易装配
IC compatible, Easy assembly
- 包装： 2000 个/卷
Package: 2000pcs/reel
- 符合 RoHS 指令要求
ROHS COMPLIANC
- 无铅产品
Pb FREE PRODUCTS
- 静电承受能力 2000V/150V/150V(HBM)
ESD 2000V/150V /150V(HBM).

产品特征 Description

- 3528 规格封装
3528 package
- 顶部发光
Top view LED
- 胶体颜色：透明
Lens Color: Water Clear
- 发光颜色 Emitted color:
 1. 红色: Red
 2. 绿色: Green
 3. 蓝色: Blue
- 晶片材质 Chips materials:
 1. AlGaInP
 2. InGaN
 3. InGaN



连云港美华电子科技有限公司

P/N:MHPA3528CRGBCT

LED PLCC

极限参数 Absolute Maximum Ratings(Ta=25℃)

参数 Parameter	符号 Symbol	极限值 Rating	单位 Unit
功耗 Power Dissipation	PAD	R:70 G:95 B:95	mW
最大峰值电流 Peak Forward Current Per Segment (1/10 duty cycle, 0.1ms pulse width)	IFP	R:100 G:100 B:100	mA
正向使用电流 Continuous Forward Current	IF	R:25 G:30 B:30	mA
反向电压 Reverse Voltage	VR	R:5 G:5 B:5	V
静电承受能力 Electrostatic Discharge Threshold(HBM)	ESD	R:2000 G:150 B:150	V
工作温度 Operating Temperature Range	TOPR	-40℃ to +85℃	
储藏温度 Storage Temperature Range	TSTG	-40℃ to +100℃	
回流焊温度 Soldering Temperature	TSOL	260℃	



连云港美华电子科技有限公司

P/N:MHPA3528CRGBCT

LED PLCC

光电特性 Optical-Electrical Characteristic(Ta=25°C)

符号 Symbol	参数 Parameter	测试条件 Test Condition	最小 Min	标准 Typ	最大 Max	单位 Unit
VF	正向压降 Forward Voltage	R:IF = 20mA	1.7	-	2.3	V
		G:IF = 20mA	2.7	-	3.3	
		B:IF = 20mA	2.7	-	3.4	
IR	反向漏电流 Reverse Current	R:VR = 5V	-	-	5	uA
		G: VR = 5V	-	-	5	
		B: VR = 5V	-	-	5	
λ_d	主波长 Dominant Wavelength	R:IF = 20mA	-	622	-	nm
		G:IF = 20mA	515	525	530	
		B:IF = 20mA	460	465	470	
2 θ 1/2	发光角度 Viewing Angle	R:IF = 20mA	-	120	-	deg
		G:IF = 20mA	-	120	-	
		B:IF = 20mA	-	120	-	
Iv	发光强度 Luminous Intensity	R:IF = 20mA	225	-	450	mcd
		G:IF = 20mA	1120	-	2250	
		B:IF = 20mA	285	-	715	

Notes:

1. 发光强度公差为±10%。 Tolerance of Luminous Intensity ±10%.
2. 正向压降公差为±0.1V。 Tolerance of Forward Voltage : ±0.1V.
3. 使用产品时需做防静电措施。 The products are sensitive to static electricity and must be carefully taken when handling products.



连云港美华电子科技有限公司

P/N:MHPA3528CRGBCT

LED PLCC

Red:

发光强度等级 Bin Range of Luminous Intensity(IV)

等级 Bin Code	最小值 Min	最大值 Max	单位 Unit	条件 Condition
S2	225	285	mcd	@20mA
T1	285	360	mcd	@20mA
T2	360	450	mcd	@20mA

Note:

发光强度公差范围：±10%。Tolerance of Luminous Intensity: ±10%@20mA/Ta=25℃



连云港美华电子科技有限公司

P/N:MHPA3528CRGBCT

LED PLCC

Green:

发光强度等级 Bin Range of Luminous Intensity(IV)

等级 Bin Code	最小值 Min	最大值 Max	单位 Unit	条件 Condition
W1	1120	1420	mcd	@20mA
W2	1420	1800	mcd	@20mA
X1	1800	2250	mcd	@20mA

Note:

发光强度公差范围: $\pm 10\%$ 。Tolerance of Luminous Intensity: $\pm 10\%$ @20mA/Ta=25°C

主波长等级 Bin Range of Dominant Wavelength(λ_d)

等级 Bin Code	最小值 Min	最大值 Max	单位 Unit	条件 Condition
A4	515	520	nm	@20mA
A5	520	525	nm	@20mA
A6	525	530	nm	@20mA

Note:

主波长公差范围: $\pm 1\text{nm}$ 。Tolerance of Dominant Wavelength: $\pm 1\text{nm}$ @20mA/Ta=25°C



连云港美华电子科技有限公司

P/N:MHPA3528CRGBCT

LED PLCC

Blue:

发光强度等级 Bin Range of Luminous Intensity(IV)

等级 Bin Code	最小值 Min	最大值 Max	单位 Unit	条件 Condition
T	285	450	mcd	@20mA
U	450	715	mcd	@20mA

Note:

发光强度公差范围: $\pm 10\%$ 。 Tolerance of Luminous Intensity: $\pm 10\%$ @20mA/Ta=25°C

主波长等级 Bin Range of Dominant Wavelength(λ_d)

等级 Bin Code	最小值 Min	最大值 Max	单位 Unit	条件 Condition
A5	460	465	nm	@20mA
A6	465	470	nm	@20mA

Note:

主波长公差范围: $\pm 1\text{nm}$ 。 Tolerance of Dominant Wavelength: $\pm 1\text{nm}$ @20mA/Ta=25°C



光电特性图 Typical Electrical Characteristic Curves(Ta=25°C Red)

Fig.1-Forward Voltage Shift vs. Junction Temperature

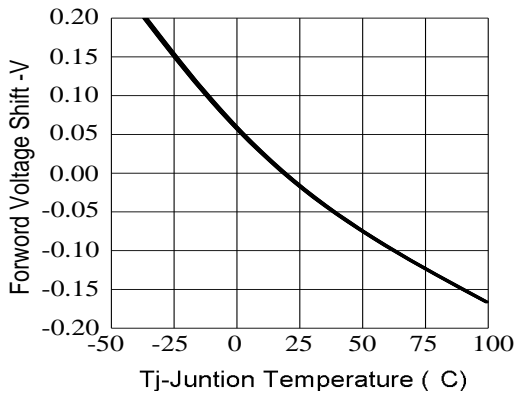

Fig.2-Relative Luminous Intensity vs. Forward Current Ts=25 C

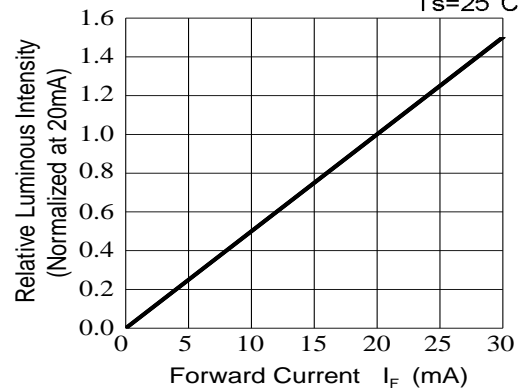

Fig.3-Relative Luminous Intensity vs. Junction Temperature

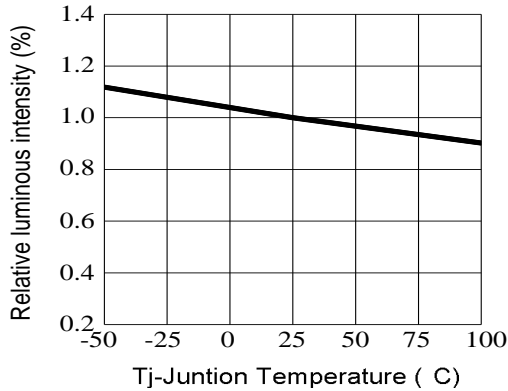

Fig.4-Forward Current vs. Forward Voltage Ta=25 C

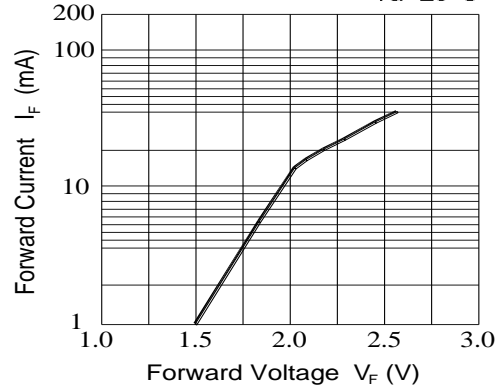

Fig.5-Max. Driving Forward Current vs. Soldering Temperature

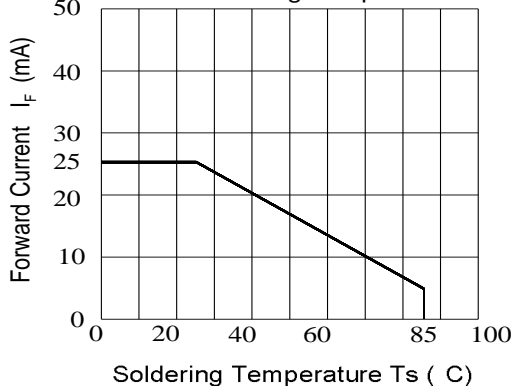
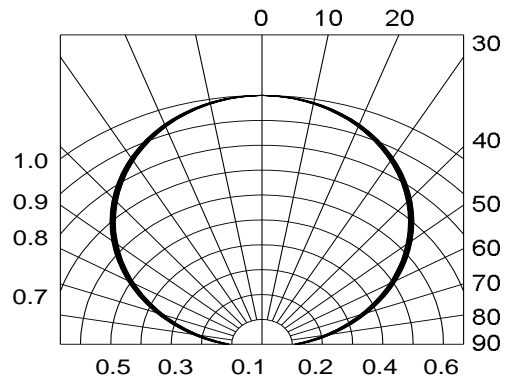

Fig.6-Radiation Diagram Ta=25 C





光电特性图 Typical Electrical Characteristic Curves(Ta=25°C Green)

Fig.1-Forward Voltage Shift vs. Junction Temperature

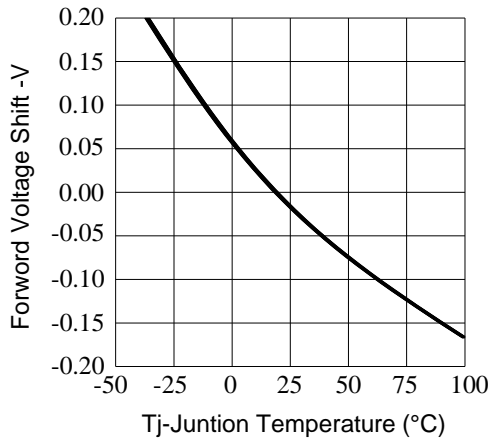

Fig.2-Relative Luminous Intensity vs. Forward Current Ts=25°C

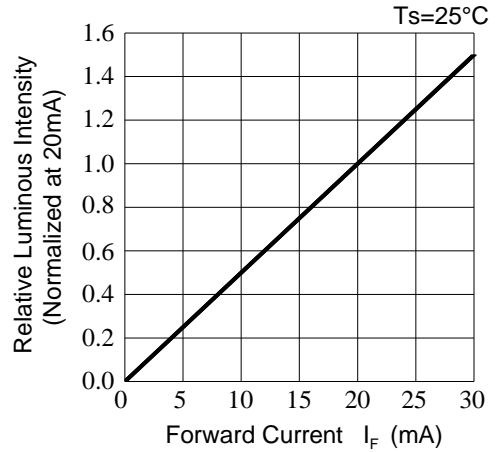

Fig.3-Relative Luminous Intensity vs. Junction Temperature

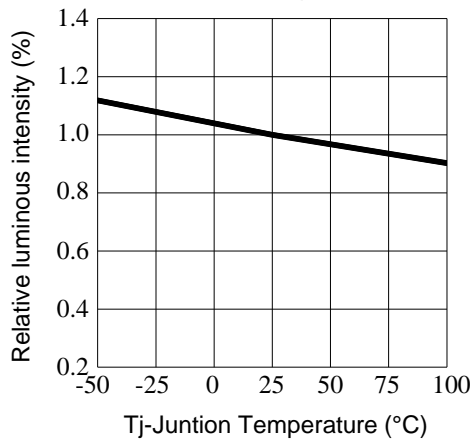

Fig.4-Forward Current vs. Forward Voltage Ta=25°C

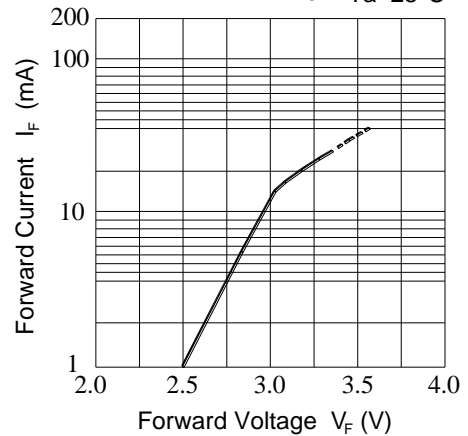

Fig.5-Max. Driving Forward Current vs. Soldering Temperature

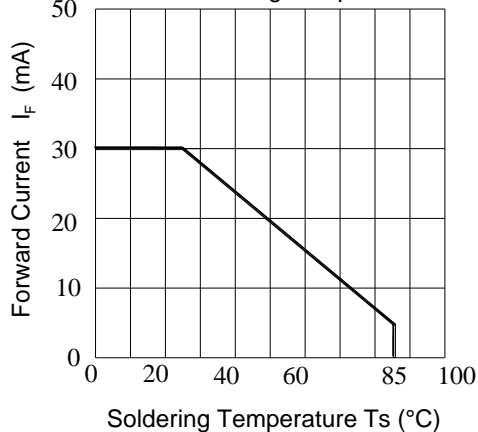
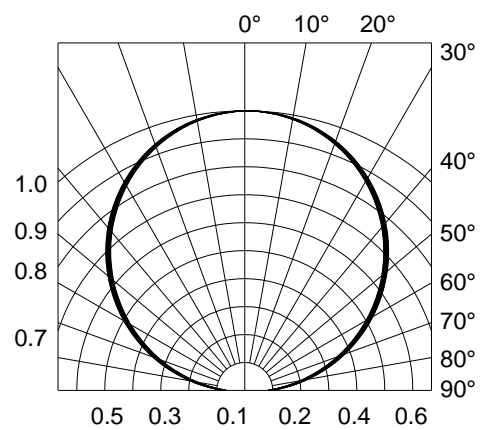
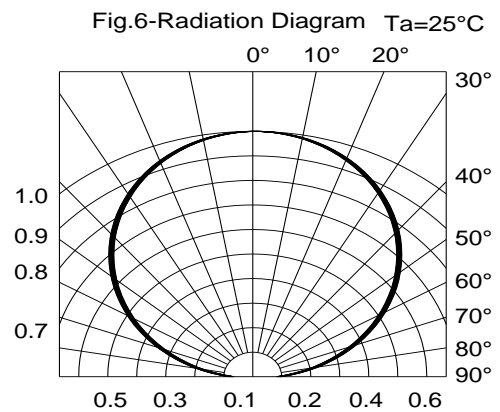
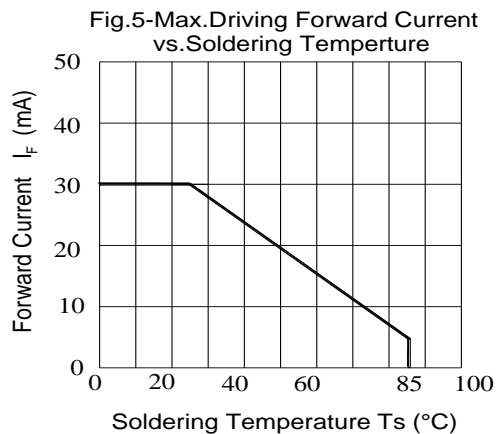
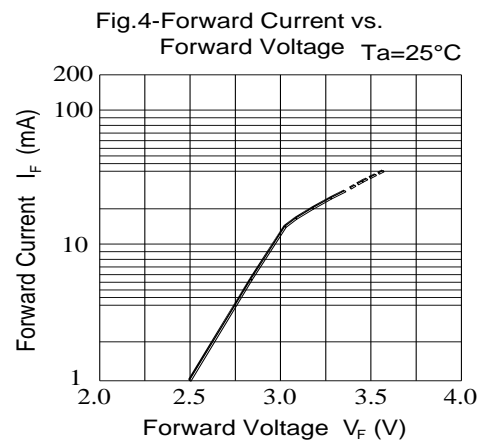
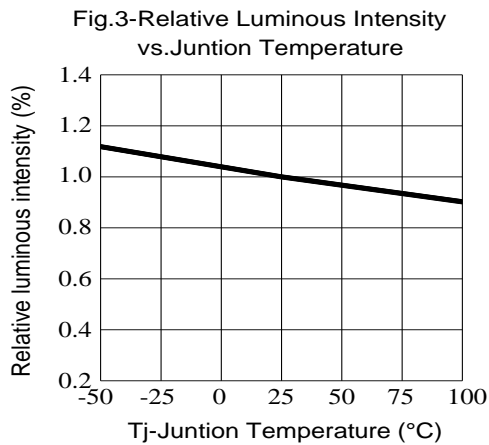
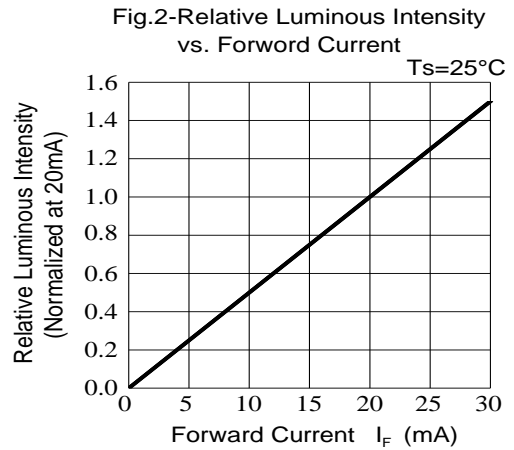
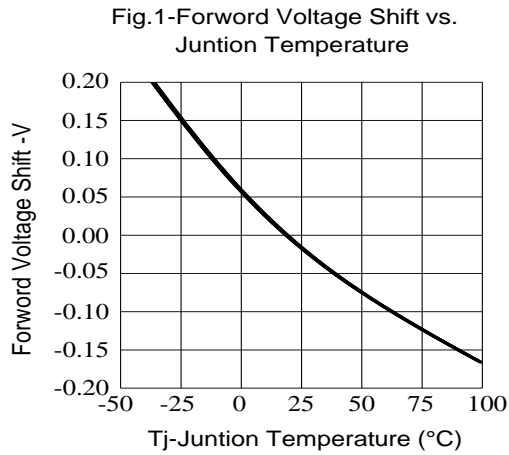

Fig.6-Radiation Diagram Ta=25°C





光电特性图 Typical Electrical Characteristic Curves(Ta=25°C Blue)





连云港美华电子科技有限公司

P/N:MHPA3528CRGBCT

LED PLCC

焊接条件 Soldering Condition

方法 METHOD	焊接条件 SOLDERING CONDITIONS	备注 REMARK
回流焊 Reflow Soldering	260°C for 10 sec.	
烙铁焊 Soldering Iron	350°C for 3 sec.	使用 25W 以下功率的电烙铁 the soldering iron capacity 25W

无铅制程炉温曲线 Pb-free solder temperature profile

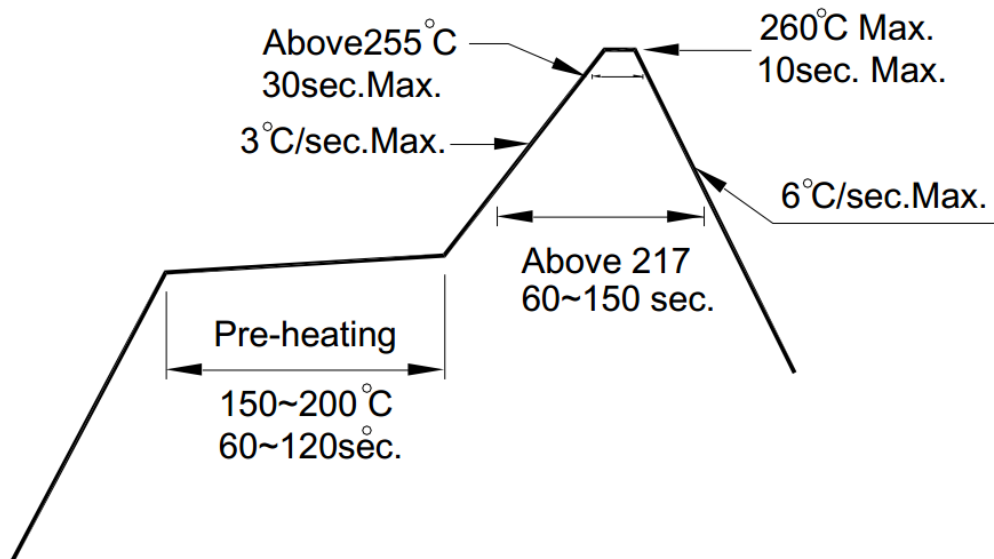

Notes:

- 过回流焊次数不可超过 2 次。
Reflow soldering should not be done more than two times.
- 焊接加热过程中不要挤压 LED
When soldering, do not put stress on the LEDs during heating.
- 焊接完成后, 不要用力玩去线路板
After soldering, do not warp the circuit board
- 客户在设计使用时需串联保护电阻, 避免电压波动烧毁发光二极管。
Customer must apply resistors for protection; otherwise slight voltage shift will cause big current change (Burn out will happen)



连云港美华电子科技有限公司

P/N:MHPA3528CRGBCT

LED PLCC

可靠度测试及条件 Reliability Test Items and Conditions

编号 No.	项目 Items	测试条件 Test Condition	测试时间 Test Hours/Cycles	样品数量 Sample Size	判定标准 Ac/Re
1	回流焊 Reflow Soldering	Temp. : 260°C/10sec.	6 Min	22pcs	0/1
2	热冲击 Thermal Shock	H : +100°C 5min ∩ 10 sec L : -10°C 5min	300 Cycles	22pcs	0/1
3	温度循环 Temperature Cycle	H : +100°C 15min ∩ 5 min L : -40°C 15min	300 Cycles	22pcs	0/1
4	高温高湿测试 High Temperature/Humidity Reverse Bias	Ta=85°C,85%RH	1000 Hrs.	22pcs	0/1
5	低温贮藏 Low Temperature Storage	Ta= - 40°C	1000 Hrs.	22pcs	0/1
6	高温贮藏 High Temperature Storage	Ta=100°C	1000 Hrs.	22pcs	0/1
7	寿命测试 DC Operation Life	Ta=25°C IF = 20 mA(Per dice)	1000 Hrs.	22pcs	0/1



连云港美华电子科技有限公司

P/N:MHPA3528CRGBCT

LED PLCC

包装 Packing

1. 卷轴尺寸 Reel Dimensions

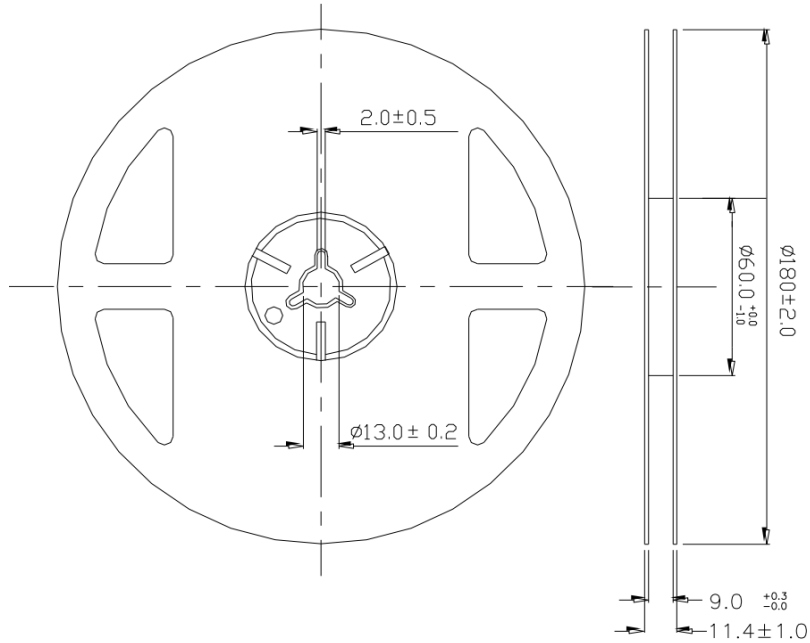

2. 载带尺寸 Carrier Tape Dimensions

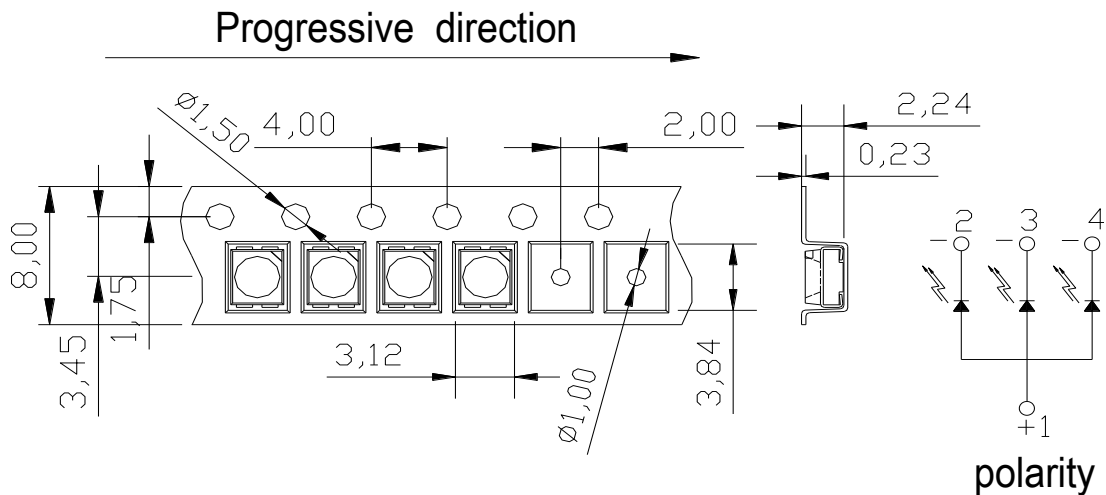

Notes:

1. 量测公差为 ± 0.1 mm，单位是毫米。

Tolerances unless mentioned ± 0.1 mm, Unit = mm

2. 最小包装数量为每卷 2000 个

Minimum packing amount is 2000 pcs per reel



连云港美华电子科技有限公司

P/N:MHPA3528CRGBCT

LED PLCC

储藏 STORAGE

1. 发光二极管在出厂后可在温度 30 度以下,湿度 60% 以下的环境内保存 1 年。The LED should be stored at 30°C or less and 60% RH or less after being shipped from MH and the storage life limits are 1 year.
2. 在产品准备使用前请不要打开防潮袋。Do not open moisture proof bag before the products are ready to use.
3. 打开包装后: 产品暴露在温度 30 度以下湿度 60% 以下的 24 小时内用完, 若仍然有剩余, 请一定要放到防潮柜内储存。After opening the package: The LED's floor life is 24 hr under 30°C or less and 60% RH or less. If unused LEDs remain, it should be stored in moisture proof packages.
4. 如果吸湿性材料(硅胶)已用完或发光二极管已超过存储时间, 应使用以下条件进行烘烤处理, 处理: 60±5°C 烘烤 5 小时。If the moisture absorbent material (silica gel) has faded away or the LEDs have exceeded the storage time, baking treatment should be performed using the following conditions. Baking treatment: 60±5°C for 5 hours.
3. 请避免保存在温度变化明显, 尤其是高湿度的地方 Please avoid rapid transitions in ambient temperature, especially, in high humidity environments where condensation can occur.

使用注意事项 Application Restrictions

1. 生产环境: 建议在 20°C~30°C&30%~60%RH 下作业。
Production environment: it is recommended to operate at 20 DEG ~30 DEG &30%~60%RH
2. 维修温度建议控制在 280°C 以下, 持续加热时间不超过 30S。
The service temperature shall be controlled below 280 degrees, and the continuous heating time shall not exceed 30S.
3. 维修时避免尖锐物体直接戳到胶体, 取料时建议夹取板材两端。
When repairing, the sharp object should be directly punched into the colloid, and when picking the material, it is recommended to clamp both ends of the PCB.



连云港美华电子科技有限公司

P/N:MHPA3528CRGBCT

LED PLCC

其他注意事项 Others

1. 本档中所描述的规范。上述规格可变更不通知。美华将对上述规格的材料更改的保留权。specification described in this document. Above specification may be changed without notice. Meihua will reserve authority on material change for above specification.

2. 使用本产品时请遵守规格书绝对最大额定值。否则美华将不承担因此引起的损失。product which does not comply with the absolute maximum ratings and the instructions included in these specification sheets. When using this product, please observe the absolute maximum ratings and the instructions for using outlined in these specification sheets. Meihua assumes no responsibility for any damage resulting from use of the product which does not comply with the absolute maximum ratings and the instructions included in these specification sheets.

3. 这些数据包括美华版权保护的材料。未经授权请不要复制。reproduce or cause anyone to reproduce them without EVERLIGHT's consent. These specification sheets include materials protected under copyright of Meihua Corporation. Please don't reproduce or cause anyone to reproduce them without Meihua's consent.

4. 静电放电（静电放电）ESD (Electrostatic Discharge)
产品敏感的静电或冲击电压。当使用产品时静电放电会损坏模具及其可靠性。对静电放电的措施强烈推荐消除电荷接地的手环，防静电鞋，衣服和地板等 The products are sensitive to static electricity or surge voltage. ESD can damage a die and its reliability. When handling the products, the following measures against electrostatic discharge are strongly recommended: Eliminating the charge Grounded wrist strap, ESD footwear, clothes, and floors

5. 发光二极管正向电流方向使用，驱动电路的设计必须使 LED 在关闭的状态下不经受正向或逆向电压，如果反向电压不断应用于发光二极管，它可以导致 LED 损坏。cause migration resulting in LED damage. The LEDs should be operated with forward bias. The driving circuit must be designed so that the LEDs are not subjected to forward or reverse voltage while it is off. If reverse voltage is continuously applied to the LEDs, it may cause migration resulting in LED damage.