

**THINKING ELECTRONIC INDUSTRIAL CO., LTD.**

HEAD OFFICE: 12F, No.93, Dashun 1st Rd., Zuoying Dist., Kaohsiung, Taiwan

TEL: 886-7-5577660 FAX: 886-7-5570560

## MANUFACTURING SITE

- KAOHSIUNG FACTORY 1:No. 51, Kaifa Rd., N.E.P.Z, Kaohsiung City 81170, Taiwan  
TEL: 886-7-9616668 FAX: 886-7-9616698
- KAOHSIUNG FACTORY 2:No. 2-2, Xinjian S. Rd., N.E.P.Z., Kaohsiung City 81170, Taiwan  
TEL: 886-7-9630001 FAX: 886-7-3635113
- CHANGZHOU FACTORY: No.6 Longmen Rd., Wujin High & New-Tech Industrial  
Development Zone, Changzhou, Jiangsu, China 213161  
TEL:86-519-86578999 FAX:86-519-86558643
- DONG GUAN FACTORY: No.45, East Rd., Sha-Tao Dist., Chang-An Town,  
Dongguan City, Guangdong, China 523863  
TEL:86-769-85542016 FAX:86-769-85546890
- YICHANG FACTORY: No. 283 Xiaoting Avenue, Xiaoting Dist., Yichang  
City 443007, Hubei, China  
TEL:86-717-6510010 FAX:86-717-6511430

**SPECIFICATION FOR APPROVAL**

CUSTOMER	立創電子
CERTIFIED MODEL/TYPE	SMBJ130
PART NO.	SMBJ130CA (RoHS+HF)
APPLICATION	
CUSTOMER P/N	
ISSUE DATE	Dec.23,2020
REV. NO.	
REV. DATE	

<b>FOR CUSTOMER APPROVAL</b>	<b>CHECKED BY</b>
	<i>Dan Zhang</i>
	<b>APPROVED BY</b>
	<i>Huaifang Zhang</i>





**REVISED RECORD SHEET**

REV. NO	REV. DATE	REVISED CONTENT



<b>INDEX</b>	<b>Page</b>
■ Part Number Code	1
■ Structure and Dimensions	2
■ Electrical Characteristics	3 ~ 4
■ Reliability	5
■ Soldering Recommendation	6
■ Packaging	7
■ Pulse Waveform	8
■ Pulse Derating Curve	8
■ Peak Pulse Power Rating Curve	9
■ Steady State Power Derating Curve	10
■ Typical Junction Capacitance	11
■ RoHS Compliant Declaration	12
■ Warehouse Storage Conditions of Products	12
■ Safety Approvals & Certificates & Test Report	13



Part Number Code

Example :

**SMBJ**   **130**   **CA**  
(1)        (2)        (3)

No.	Item	Digit	Specification
(1)	Product Type	SMBJ	Thinking Power TVS SMD Type
(2)	Reverse Stand off Voltage ( $V_{RWM}$ )	130	130=130 $V_{RWM}$
(3)	Type Code	CA	Bi-directional 5% VBR Voltage Tolerance

### Structure and Dimensions

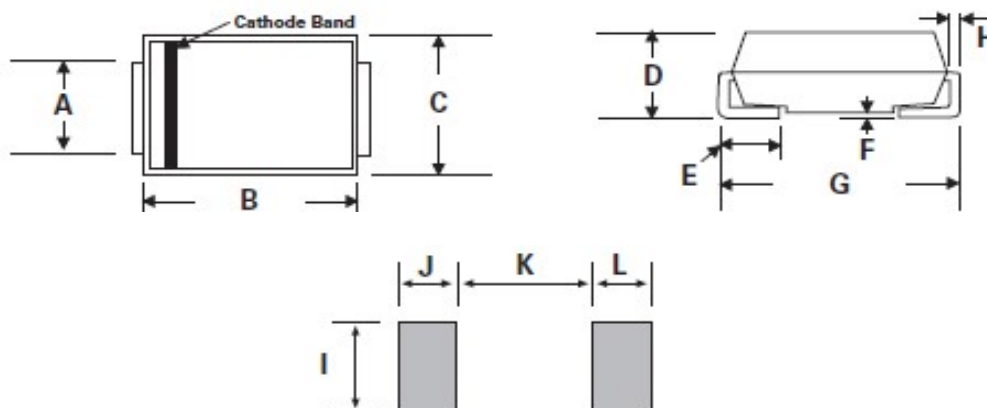

\*The Cathode bend for Uni-directional product only.

Item	Millimeters		Inches	
	Min.	Max.	Min.	Max.
A	1.91	2.2	0.075	0.086
B	4.06	4.7	0.16	0.185
C	3.3	3.94	0.13	0.155
D	2.13	2.70	0.083	0.096
E	0.76	1.52	0.03	0.06
F	-	0.203	-	0.008
G	5.08	5.59	0.2	0.22
H	0.152	0.305	0.006	0.012
I	2.26	-	0.089	-
J/L	2.16	-	0.085	-
K	-	2.74	-	0.107

## Electrical Characteristics

Peak power dissipation with a 10/1000 $\mu$ s waveform : 600W

Operating junction and storage temperature range : -55~+150 °C

Part No. (Uni)	Part No. (Bi)	Reverse Stand off Voltage	Breakage Voltage VBR @ IT		Test Current	Maximum Clamping Voltage VC @ Ipp	Maximum Peak Pulse Current	Maximum Reverse Leakage IR @VRWM	Marking Code	
			VRWM ( V )	Min( V )					Max( V )	IT( mA )
SMBJ5.0A	SMBJ5.0CA	5	6.4	7	10	9.2	65.3	800	KE.	AE.
SMBJ6.0A	SMBJ6.0CA	6	6.67	7.37	10	10.3	58.3	800	KG.	AG.
SMBJ6.5A	SMBJ6.5CA	6.5	7.22	7.98	10	11.2	53.6	500	KK.	AK.
SMBJ7.0A	SMBJ7.0CA	7	7.78	8.6	10	12	50	200	KM.	AM.
SMBJ7.5A	SMBJ7.5CA	7.5	8.33	9.21	1	12.9	46.6	100	KP.	AP.
SMBJ8.0A	SMBJ8.0CA	8	8.89	9.83	1	13.6	44.2	50	KR.	AR.
SMBJ8.5A	SMBJ8.5CA	8.5	9.44	10.4	1	14.4	41.7	20	KT.	AT.
SMBJ9.0A	SMBJ9.0CA	9	10	11.1	1	15.4	39	10	KV.	AV.
SMBJ10A	SMBJ10CA	10	11.1	12.3	1	17	35.3	5	KX.	AX.
SMBJ11A	SMBJ11CA	11	12.2	13.5	1	18.2	33	1	KZ.	AZ.
SMBJ12A	SMBJ12CA	12	13.3	14.7	1	19.9	30.2	1	LE.	BE.
SMBJ13A	SMBJ13CA	13	14.4	15.9	1	21.5	28	1	LG.	BG.
SMBJ14A	SMBJ14CA	14	15.6	17.2	1	23.2	25.9	1	LK.	BK.
SMBJ15A	SMBJ15CA	15	16.7	18.5	1	24.4	24.6	1	LM.	BM.
SMBJ16A	SMBJ16CA	16	17.8	19.7	1	26	23.1	1	LP.	BP.
SMBJ17A	SMBJ17CA	17	18.9	20.9	1	27.6	21.8	1	LR.	BR.
SMBJ18A	SMBJ18CA	18	20	22.1	1	29.2	20.6	1	LT.	BT.
SMBJ20A	SMBJ20CA	20	22.2	24.5	1	32.4	18.6	1	LV.	BV.
SMBJ22A	SMBJ22CA	22	24.4	26.9	1	35.5	16.9	1	LX.	BX.
SMBJ24A	SMBJ24CA	24	26.7	29.5	1	38.9	15.5	1	LZ.	BZ.
SMBJ26A	SMBJ26CA	26	28.9	31.9	1	42.1	14.3	1	ME.	CE.
SMBJ28A	SMBJ28CA	28	31.1	34.4	1	45.4	13.3	1	MG.	CG.
SMBJ30A	SMBJ30CA	30	33.3	36.8	1	48.4	12.4	1	MK.	CK.
SMBJ33A	SMBJ33CA	33	36.7	40.6	1	53.3	11.3	1	MM.	CM.
SMBJ36A	SMBJ36CA	36	40	44.2	1	58.1	10.4	1	MP.	CP.
SMBJ40A	SMBJ40CA	40	44.4	49.1	1	64.5	9.3	1	MR.	CR.
SMBJ43A	SMBJ43CA	43	47.8	52.8	1	69.4	8.7	1	MT.	CT.
SMBJ45A	SMBJ45CA	45	50	55.3	1	72.7	8.3	1	MV.	CV.
SMBJ48A	SMBJ48CA	48	53.3	58.9	1	77.4	7.8	1	MX.	CX.
SMBJ51A	SMBJ51CA	51	56.7	62.7	1	82.4	7.3	1	MZ.	CZ.
SMBJ54A	SMBJ54CA	54	60	66.3	1	87.1	6.9	1	NE.	DE.
SMBJ58A	SMBJ58CA	58	64.4	71.2	1	93.6	6.5	1	NG.	DG.
SMBJ60A	SMBJ60CA	60	66.7	73.7	1	96.8	6.2	1	NK.	DK.

Electrical CharacteristicsPeak power dissipation with a 10/1000 $\mu$ s waveform : 600W

Operating junction and storage temperature range : -55~+150 °C

Part No. (Uni)	Part No. (Bi)	Reverse Stand off Voltage	Breakage Voltage VBR @ IT		Test Current	Maximum Clamping Voltage VC @ Ipp	Maximum Peak Pulse Current	Maximum Reverse Leakage IR @VRWM	Marking Code	
			VRWM ( V )	Min( V )					Max( V )	IT( mA )
SMBJ64A	SMBJ64CA	64	71.1	78.6	1	103	5.9	1	NM.	DM.
SMBJ70A	SMBJ70CA	70	77.8	86	1	113	5.3	1	NP.	DP.
SMBJ75A	SMBJ75CA	75	83.3	92.1	1	121	5	1	NR.	DR.
SMBJ78A	SMBJ78CA	78	86.7	95.8	1	126	4.8	1	NT.	DT.
SMBJ85A	SMBJ85CA	85	94.4	104	1	137	4.4	1	NV.	DV.
SMBJ90A	SMBJ90CA	90	100	111	1	146	4.1	1	NX.	DX.
SMBJ100A	SMBJ100CA	100	111	123	1	162	3.7	1	NZ.	DZ.
SMBJ110A	SMBJ110CA	110	122	135	1	177	3.4	1	PE.	EE.
SMBJ120A	SMBJ120CA	120	133	147	1	193	3.1	1	PG.	EG.
SMBJ130A	SMBJ130CA	130	144	159	1	209	2.9	1	PK.	EK.
SMBJ150A	SMBJ150CA	150	167	185	1	243	2.5	1	PM.	EM.
SMBJ160A	SMBJ160CA	160	178	197	1	259	2.3	1	PP.	EP.
SMBJ170A	SMBJ170CA	170	189	209	1	275	2.2	1	PR.	ER.
SMBJ180A	SMBJ180CA	180	201	222	1	292	2.1	1	PT.	ET.
SMBJ190A	SMBJ190CA	190	209	243	1	308	2	1	PV.	EV.
SMBJ200A	SMBJ200CA	200	224	247	1	324	1.9	1	PW.	EW.
SMBJ220A	SMBJ220CA	220	246	272	1	356	1.7	1	PX.	EX.
SMBJ250A	SMBJ250CA	250	279	309	1	405	1.5	1	PZ.	EZ.
SMBJ300A	SMBJ300CA	300	335	371	1	486	1.3	1	QE.	FE.
SMBJ350A	SMBJ350CA	350	391	432	1	567	1.1	1	QG.	FG.
SMBJ400A	SMBJ400CA	400	447	494	1	648	0.9	1	QK.	FK.
SMBJ440A	SMBJ440CA	440	492	543	1	713	0.9	1	QM.	FM.

Reliability

Item	Standard	Test conditions / Methods	Specifications
HTRB (High Temp. Reverse Bias Test)	MIL-STD-750D METHOD 1038.3 Method 103	Test Temp. : 150°C Duration 168 hrs with rated VRWM	Electrical properties meet Specifications
PCT (Pressure Cooker Test)	MIL-STD-19500 EAPPENDIX C	Test Temp. : 121 °C Pressure:1.2Kg Duration: 96 hrs	Electrical properties meet Specifications
TCT	MIL-STD-750D METHOD 1051.5	Test Temp. : -55°C ~+150°C 20 cycles	Electrical properties meet Specifications
Forward Surge	MIL-STD-750D METHOD 4066.3	Sine half wave 8.3mS 1 shot IFSM:20A forSMF 40A for SMA/ P4SMA & SMAF 100A for SMB/P6SMB 200A for SMC/1.5SMC For Uni-directional product only.	Electrical properties meet Specifications
Soldering Heat	MIL-STD-750D METHOD 2031.2	Test Temp. : 260°C Duration:10 sec 1cycle	Electrical properties meet Specifications



## Soldering Recommendation

### ■ IR-reflow soldering profile



Reflow Condition	Lead-free assembly
<b>Preheat</b> -Temperature Min(Ts min) -Temperature Min(Ts max) -Time (min to max) (ts)	150°C 200°C 60 – 180 seconds
<b>Average ramp up rate</b> -Temperature Liquidus (TL) to peak	3°C/second max
<b>Ts(max) to TL</b> -Ramp-up Rate	3°C/second max.
<b>Reflow</b> -Temperature Liquidus (TL) -Time (tl)	217°C 60 – 150 seconds
<b>Peak Temperature (TP)</b>	260°C
<b>Time within 5°C of actual peak Temperature(tp)</b>	20 – 40 seconds
<b>Ramp-down Rate</b>	6°C/second max.
<b>Time 25°C to peak Temperature(TP)</b>	8 minutes max.
<b>Do not exceed</b>	260°C

Packaging

■ Taping Specification

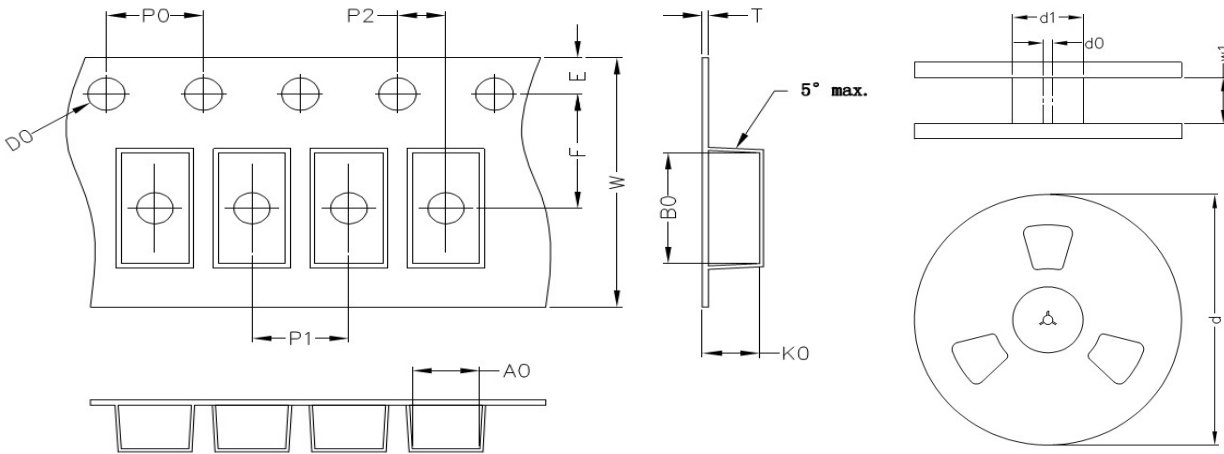

(Unit : mm)

Index	A0	B0	K0	D0	E	F	P0	P1	P2	T	W	d(13")	d1	d0	w1
SMBJ	3.65±0.1	5.6±0.1	2.57±0.1	1.55	1.75	5.5	4	8	2	0.25	12	330	75	13.5	13.5

Notes: The tolerance of carrier tape and top cover is ±0.1mm, the tolerance of reel is ±2mm

■ Quantity

Series Type	Reel size	Quantity (pcs/reel)
SMBJ	13"	3,000

Pulse Waveform

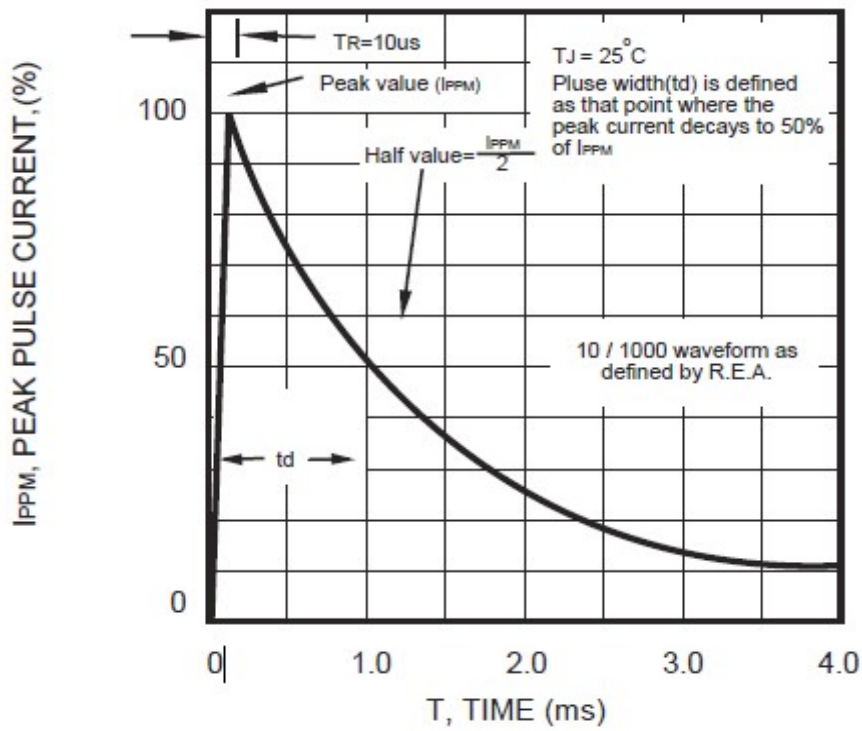

Pulse Derating Curve

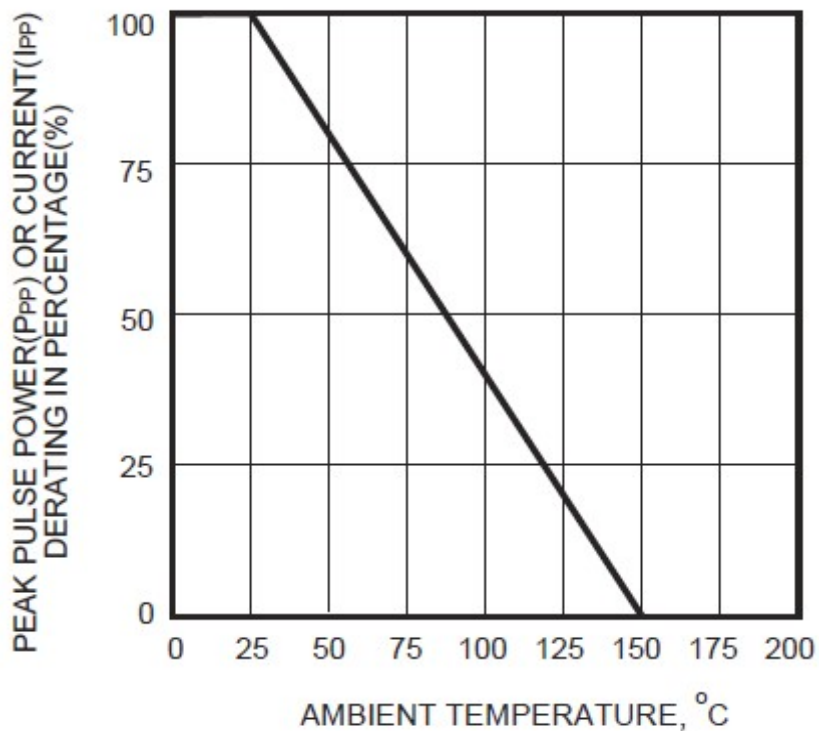

Peak Pulse Power Rating Curve

SMBJ series

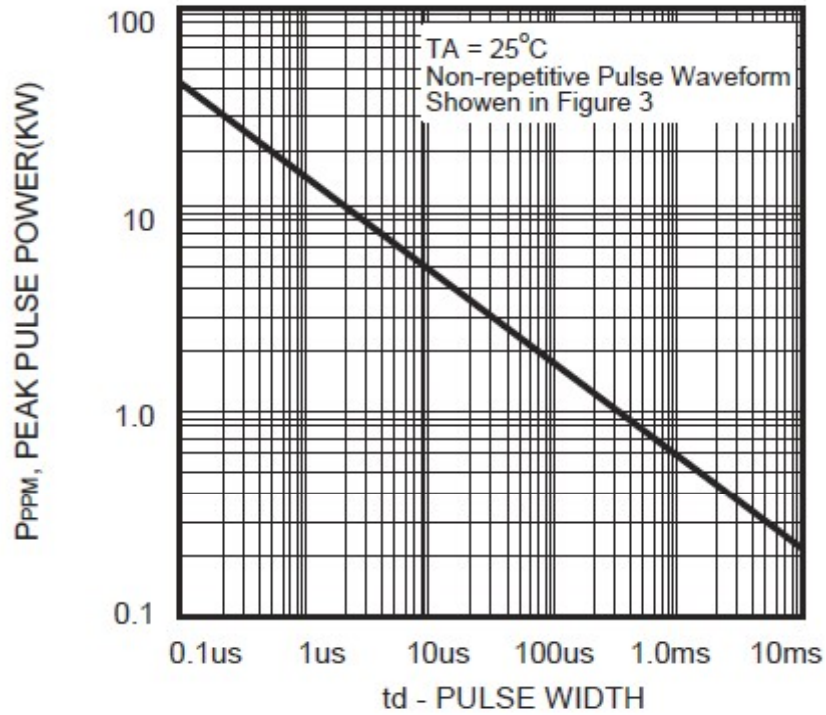

Steady State Power Derating Curve

SMBJ series

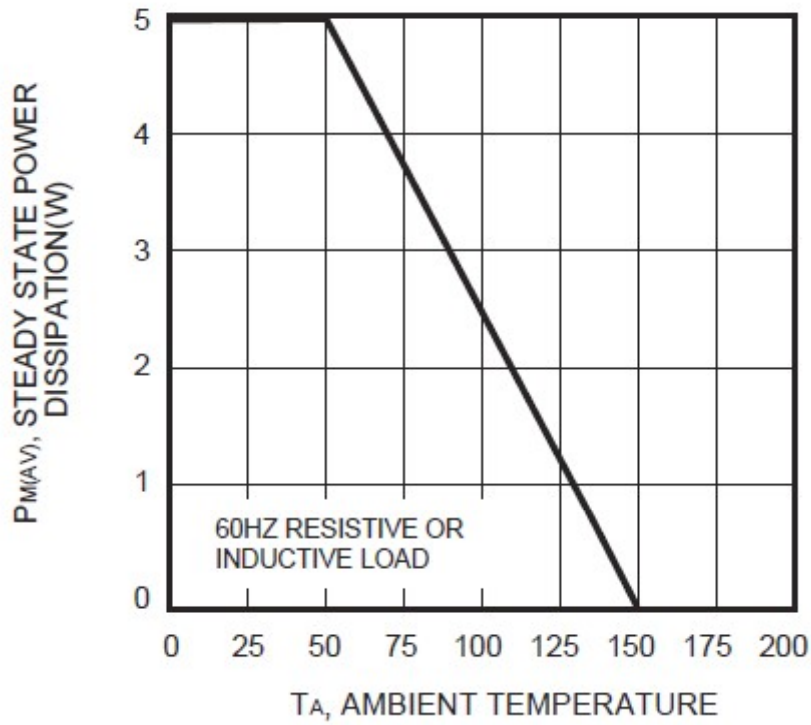

### Typical Junction Capacitance

SMBJ series

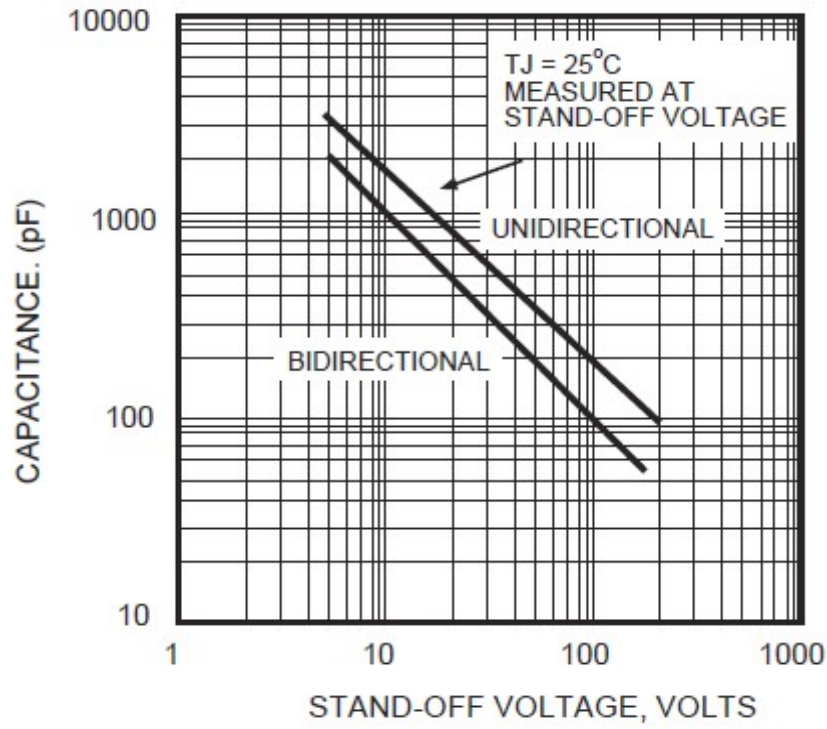

### RoHS Compliant Declaration

We hereby declare that the components delivered to your company are compliant with RoHS directive 2015/863/EU.

### Warehouse Storage Conditions of Products

(I) Storage Conditions :

- 1.Storage Temperature :  $-10^{\circ}\text{C} \sim +40^{\circ}\text{C}$
- 2.Relative Humidity :  $\leq 75\%RH$
- 3.Keep away from corrosive atmosphere and sunlight.

(II) Period of Storage : 1 year

## Safety Approvals



\* UL 497B recognized (File # E229991)

## Certificates

- (1) IATF 16949 certificate
- (2) ISO 9001 certificate

## Test Report

- (1) RoHS test report
- (2) Halogen-free test report