



# THINKING ELECTRONIC INDUSTRIAL CO., LTD.

HEAD OFFICE: 12F, No.93, Dashun 1st Rd., Zuoying Dist., Kaohsiung, Taiwan  
TEL: 886-7-5577660 FAX: 886-7-5570560

## MANUFACTURING SITE

- KAOHSIUNG FACTORY 1:No. 51, Kaifa Rd., N.E.P.Z, Kaohsiung City 81170, Taiwan  
TEL: 886-7-9616668 FAX: 886-7-9616698
- KAOHSIUNG FACTORY 2:No. 2-2, Xinjian S. Rd., N.E.P.Z., Kaohsiung City 81170, Taiwan  
TEL: 886-7-9630001 FAX: 886-7-3635113
- CHANGZHOU FACTORY: No.6 Longmen Rd., Wujin High & New-Tech Industrial Development Zone, Changzhou, Jiangsu, China 213161  
TEL:86-519-86578999 FAX:86-519-86558643
- DONG GUAN FACTORY: No.45, East Rd., Sha-Tao Dist., Chang-An Town, Dongguan City, Guangdong, China 523863  
TEL:86-769-85542016 FAX:86-769-85546890
- YICHANG FACTORY: No. 283 Xiaoting Avenue, Xiaoting Dist., Yichang City 443007, Hubei, China  
TEL:86-717-6510010 FAX:86-717-6511430



## SPECIFICATION FOR APPROVAL

CUSTOMER 立創電子

CERTIFIED MODEL/TYPE SMAJ26

PART NO. SMAJ26CA (RoHS+HF)

APPLICATION \_\_\_\_\_

CUSTOMER P/N \_\_\_\_\_

ISSUE DATE Dec.07,2020

REV. NO. \_\_\_\_\_

REV. DATE \_\_\_\_\_

FOR CUSTOMER APPROVAL	CHECKED BY
	<i>Dan Zhang</i>
	APPROVED BY
	<i>Huaifang Zhang</i>





**REVISED RECORD SHEET**

REV. NO	REV. DATE	REVISED CONTENT



<b>INDEX</b>	<b>Page</b>
■ Part Number Code	1
■ Structure and Dimensions	2
■ Electrical Characteristics	3 ~ 4
■ Reliability	5
■ Soldering Recommendation	6
■ Packaging	7
■ Pulse Waveform	8
■ Pulse Derating Curve	8
■ Peak Pulse Power Rating Curve	9
■ Steady State Power Derating Curve	10
■ Typical Junction Capacitance	11
■ RoHS Compliant Declaration	12
■ Warehouse Storage Conditions of Products	12
■ Safety Approvals & Certificates & Test Report	13

Part Number Code

Example :

**SMAJ**    **26**    **CA**  
 (1)            (2)        (3)

No.	Item	Digit	Specification
(1)	Product Type	SMAJ	Thinking Power TVS SMD Type
(2)	Reverse Stand off Voltage ( $V_{RWM}$ )	26	26=26 $V_{RWM}$
(3)	Type Code	CA	Bi-directional 5% VBR Voltage Tolerance

Structure and Dimensions

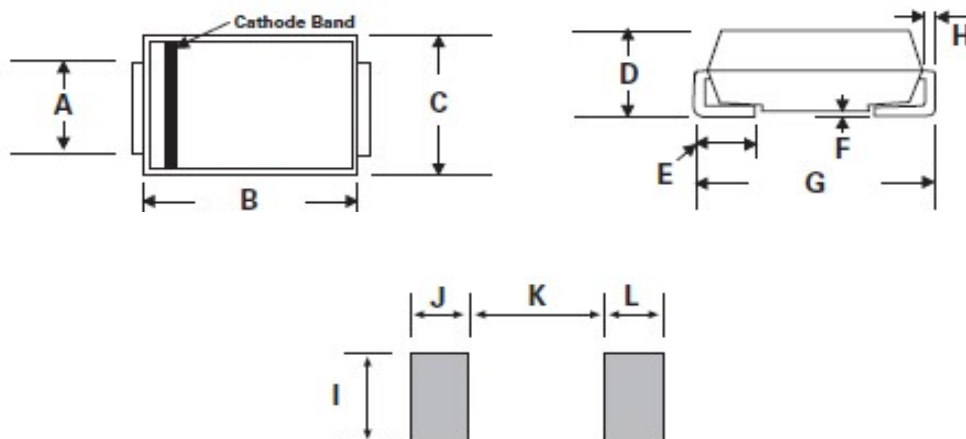

\* The Cathode bend for Uni-directional product only.

Item	Millimeters		Inches	
	Min.	Max.	Min.	Max.
A	1.25	1.65	0.049	0.065
B	3.99	4.6	0.157	0.181
C	2.4	2.8	0.094	0.11
D	1.9	2.3	0.074	0.09
E	0.76	1.52	0.03	0.06
F	-	0.203	-	0.008
G	4.8	5.28	0.188	0.208
H	0.152	0.305	0.006	0.012
I	1.8	-	0.07	-
J/L	2.1	-	0.082	-
K	-	2.3	-	0.09

## Electrical Characteristics

Peak power dissipation with a 10/1000µs waveform : 400W

Operating junction and storage temperature range : -55~+150 °C

Part No. (Uni)	Part No. (Bi)	Reverse Stand off Voltage	Breakage Voltage VBR @ IT		Test Current	Maximum Clamping Voltage VC @ Ipp	Maximum Peak Pulse Current	Maximum Reverse Leakage IR @VRWM	Marking Code	
			VRWM ( V )	Min( V )					Max( V )	IT( mA )
SMAJ5.0A	SMAJ5.0CA	5	6.4	7	10	9.2	43.5	800	AE.	WE.
SMAJ6.0A	SMAJ6.0CA	6	6.67	7.37	10	10.3	38.8	800	AG.	WG.
SMAJ6.5A	SMAJ6.5CA	6.5	7.22	7.98	10	11.2	35.7	500	AK.	WK.
SMAJ7.0A	SMAJ7.0CA	7	7.78	8.6	10	12	33.3	200	AM.	WM.
SMAJ7.5A	SMAJ7.5CA	7.5	8.33	9.21	1	12.9	31	100	AP.	WP.
SMAJ8.0A	SMAJ8.0CA	8	8.89	9.83	1	13.6	29.4	50	AR.	WR.
SMAJ8.5A	SMAJ8.5CA	8.5	9.44	10.4	1	14.4	27.8	20	AT.	WT.
SMAJ9.0A	SMAJ9.0CA	9	10	11.1	1	15.4	26	10	AV.	WV.
SMAJ10A	SMAJ10CA	10	11.1	12.3	1	17	23.5	5	AX.	WX.
SMAJ11A	SMAJ11CA	11	12.2	13.5	1	18.2	22	1	AZ.	WZ.
SMAJ12A	SMAJ12CA	12	13.3	14.7	1	19.9	20.1	1	BE.	XE.
SMAJ13A	SMAJ13CA	13	14.4	15.9	1	21.5	18.6	1	BG.	XG.
SMAJ14A	SMAJ14CA	14	15.6	17.2	1	23.2	17.2	1	BK.	XK.
SMAJ15A	SMAJ15CA	15	16.7	18.5	1	24.4	16.4	1	BM.	XM.
SMAJ16A	SMAJ16CA	16	17.8	19.7	1	26	15.4	1	BP.	XP.
SMAJ17A	SMAJ17CA	17	18.9	20.9	1	27.6	14.5	1	BR.	XR.
SMAJ18A	SMAJ18CA	18	20	22.1	1	29.2	13.7	1	BT.	XT.
SMAJ20A	SMAJ20CA	20	22.2	24.5	1	32.4	12.3	1	BV.	XV.
SMAJ22A	SMAJ22CA	22	24.4	26.9	1	35.5	11.3	1	BX.	XX.
SMAJ24A	SMAJ24CA	24	26.7	29.5	1	38.9	10.3	1	BZ.	XZ.
SMAJ26A	SMAJ26CA	26	28.9	31.9	1	42.1	9.5	1	CE.	YE.
SMAJ28A	SMAJ28CA	28	31.1	34.4	1	45.4	8.8	1	CG.	YG.
SMAJ30A	SMAJ30CA	30	33.3	36.8	1	48.4	8.3	1	CK.	YK.
SMAJ33A	SMAJ33CA	33	36.7	40.6	1	53.3	7.5	1	CM.	YM.
SMAJ36A	SMAJ36CA	36	40	44.2	1	58.1	6.9	1	CP.	YP.
SMAJ40A	SMAJ40CA	40	44.4	49.1	1	64.5	6.2	1	CR.	YR.
SMAJ43A	SMAJ43CA	43	47.8	52.8	1	69.4	5.8	1	CT.	YT.
SMAJ45A	SMAJ45CA	45	50	55.3	1	72.7	5.5	1	CV.	YV.
SMAJ48A	SMAJ48CA	48	53.3	58.9	1	77.4	5.2	1	CX.	YX.
SMAJ51A	SMAJ51CA	51	56.7	62.7	1	82.4	4.9	1	CZ.	YZ.
SMAJ54A	SMAJ54CA	54	60	66.3	1	87.1	4.6	1	RE.	ZE.
SMAJ58A	SMAJ58CA	58	64.4	71.2	1	93.6	4.3	1	RG.	ZG.
SMAJ60A	SMAJ60CA	60	66.7	73.7	1	96.8	4.1	1	RK.	ZK.

Electrical CharacteristicsPeak power dissipation with a 10/1000 $\mu$ s waveform : 400W

Operating junction and storage temperature range : -55~+150 °C

Part No. (Uni)	Part No. (Bi)	Reverse Stand off Voltage	Breakage Voltage VBR @ IT		Test Current	Maximum Clamping Voltage VC @ Ipp	Maximum Peak Pulse Current	Maximum Reverse Leakage IR @VRWM	Marking Code	
			VRWM ( V )	Min( V )					Max( V )	IT( mA )
SMAJ64A	SMAJ64CA	64	71.1	78.6	1	103	3.9	1	RM.	ZM.
SMAJ70A	SMAJ70CA	70	77.8	86	1	113	3.5	1	RP.	ZP.
SMAJ75A	SMAJ75CA	75	83.3	92.1	1	121	3.3	1	RR.	ZR.
SMAJ78A	SMAJ78CA	78	86.7	95.8	1	126	3.2	1	RT.	ZT.
SMAJ85A	SMAJ85CA	85	94.4	104	1	137	2.9	1	RV.	ZV.
SMAJ90A	SMAJ90CA	90	100	111	1	146	2.7	1	RX.	ZX.
SMAJ100A	SMAJ100CA	100	111	123	1	162	2.5	1	RZ.	ZZ.
SMAJ110A	SMAJ110CA	110	122	135	1	177	2.3	1	SE.	VE.
SMAJ120A	SMAJ120CA	120	133	147	1	193	2.1	1	SG.	VG.
SMAJ130A	SMAJ130CA	130	144	159	1	209	1.9	1	SK.	VK.
SMAJ150A	SMAJ150CA	150	167	185	1	243	1.6	1	SM.	VM.
SMAJ160A	SMAJ160CA	160	178	197	1	259	1.5	1	SP.	VP.
SMAJ170A	SMAJ170CA	170	189	209	1	275	1.5	1	SR.	VR.
SMAJ180A	SMAJ180CA	180	201	222	1	292	1.4	1	ST.	VT.
SMAJ190A	SMAJ190CA	190	209	243	1	308	1.3	1	SV.	VV.
SMAJ200A	SMAJ200CA	200	224	247	1	324	1.2	1	SW.	VW.
SMAJ220A	SMAJ220CA	220	246	272	1	356	1.1	1	SX.	VX.
SMAJ250A	SMAJ250CA	250	279	309	1	405	1	1	SZ.	VZ.
SMAJ300A	SMAJ300CA	300	335	371	1	486	0.8	1	DE.	HE.
SMAJ350A	SMAJ350CA	350	391	432	1	567	0.7	1	DG.	HG.
SMAJ400A	SMAJ400CA	400	447	494	1	648	0.6	1	DK.	HK.
SMAJ440A	SMAJ440CA	440	492	543	1	713	0.6	1	DM.	HM.

**Reliability**

Item	Standard	Test conditions / Methods	Specifications
HTRB (High Temp. Reverse Bias Test)	MIL-STD-750D METHOD 1038.3 Method 103	Test Temp. : 150°C Duration 168 hrs with rated VRWM	Electrical properties meet Specifications
PCT (Pressure Cooker Test)	MIL-STD-19500 EAPPENDIX C	Test Temp. : 121 °C Pressure:1.2Kg Duration: 96 hrs	Electrical properties meet Specifications
TCT	MIL-STD-750D METHOD 1051.5	Test Temp. : -55°C ~+150°C 20 cycles	Electrical properties meet Specifications
Forward Surge	MIL-STD-750D METHOD 4066.3	Sine half wave 8.3mS 1 shot IFSM:20A forSMF 40A for SMA/ P4SMA & SMAF 100A for SMB/P6SMB 200A for SMC/1.5SMC For Uni-directional product only.	Electrical properties meet Specifications
Soldering Heat	MIL-STD-750D METHOD 2031.2	Test Temp. : 260°C Duration:10 sec 1cycle	Electrical properties meet Specifications



## Soldering Recommendation

### ■ IR-reflow soldering profile



Reflow Condition	Lead-free assembly
<b>Preheat</b> -Temperature Min(Ts min) -Temperature Min(Ts max) -Time (min to max) (ts)	150°C 200°C 60 – 180 seconds
<b>Average ramp up rate</b> -Temperature Liquidus (TL) to peak	3°C/second max
<b>Ts(max) to TL</b> -Ramp-up Rate	3°C/second max.
<b>Reflow</b> -Temperature Liquidus (TL) -Time (tL)	217°C 60 – 150 seconds
<b>Peak Temperature (TP)</b>	260°C
<b>Time within 5°C of actual peak Temperature(tp)</b>	20 – 40 seconds
<b>Ramp-down Rate</b>	6°C/second max.
<b>Time 25°C to peak Temperature(TP)</b>	8 minutes max.
<b>Do not exceed</b>	260°C

## Packaging

### ■ Taping Specification

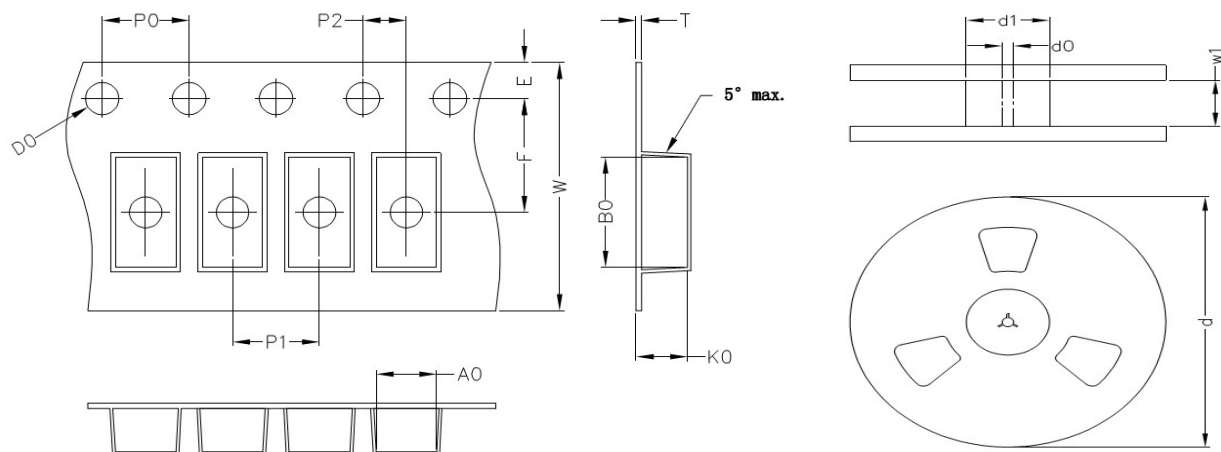

(Unit : mm)

Index	A0	B0	K0	D0	E	F	P0	P1	P2	T	W	d(13")	d1	d0	w1
SMAJ	2.8	5.33	2.36	1.55	1.75	5.5	4	4	2	0.22±0.05	12	330	75	13.5	13.5

Notes: The tolerance of carrier tape and top cover is  $\pm 0.1$ mm, the tolerance of reel is  $\pm 2$ mm

### ■ Quantity

Series Type	Reel size	Quantity (pcs/reel)
SMAJ	13"	5,000

Pulse Waveform

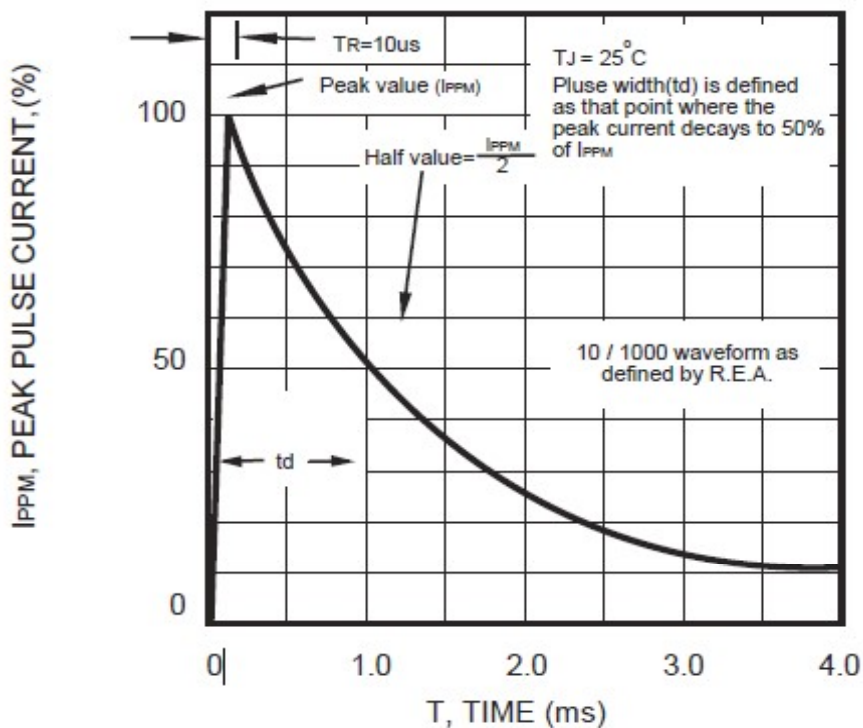

Pulse Derating Curve

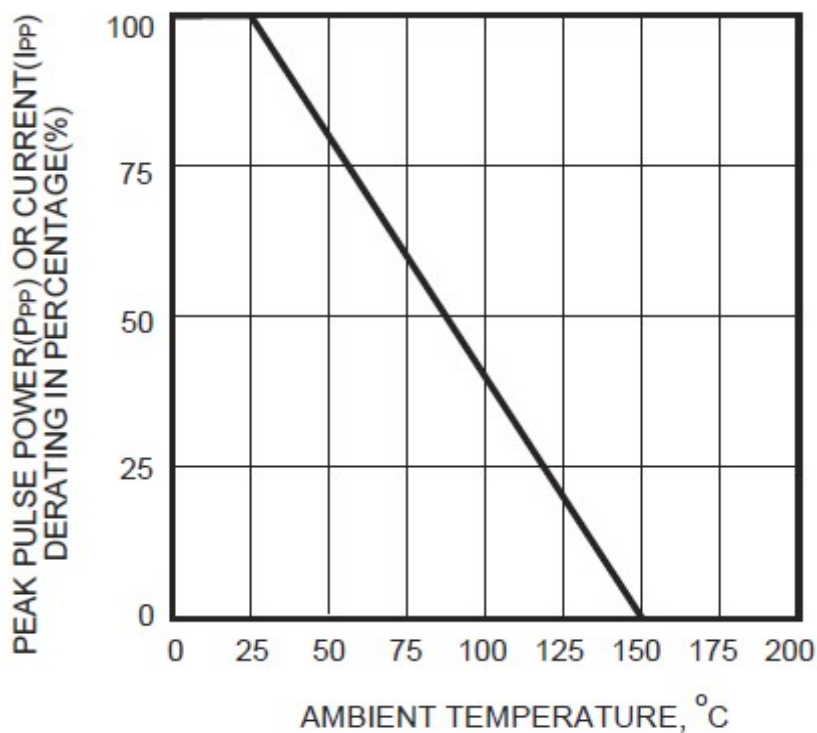

Peak Pulse Power Rating Curve

SMAJ series

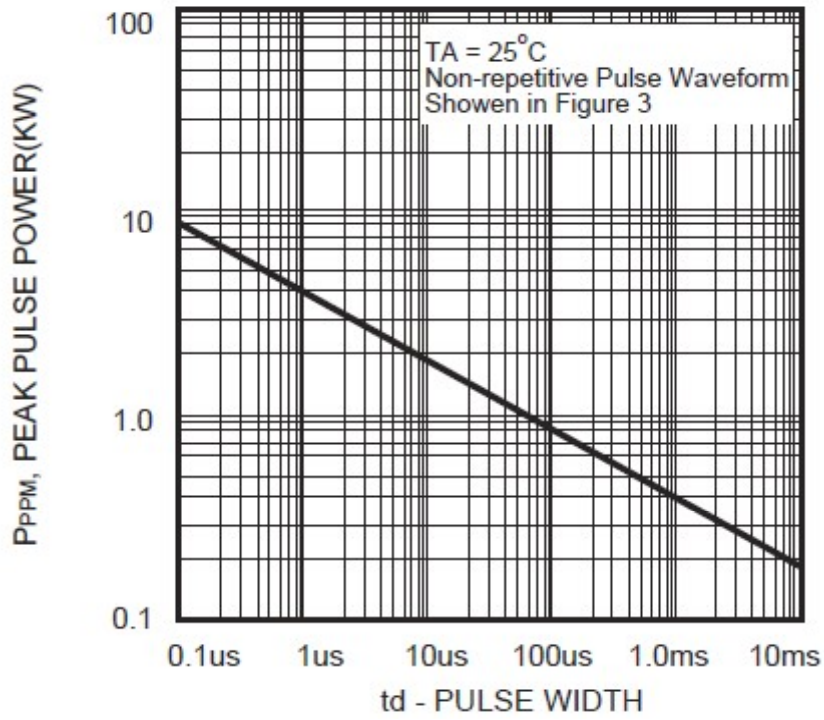

Steady State Power Derating Curve

SMAJ series

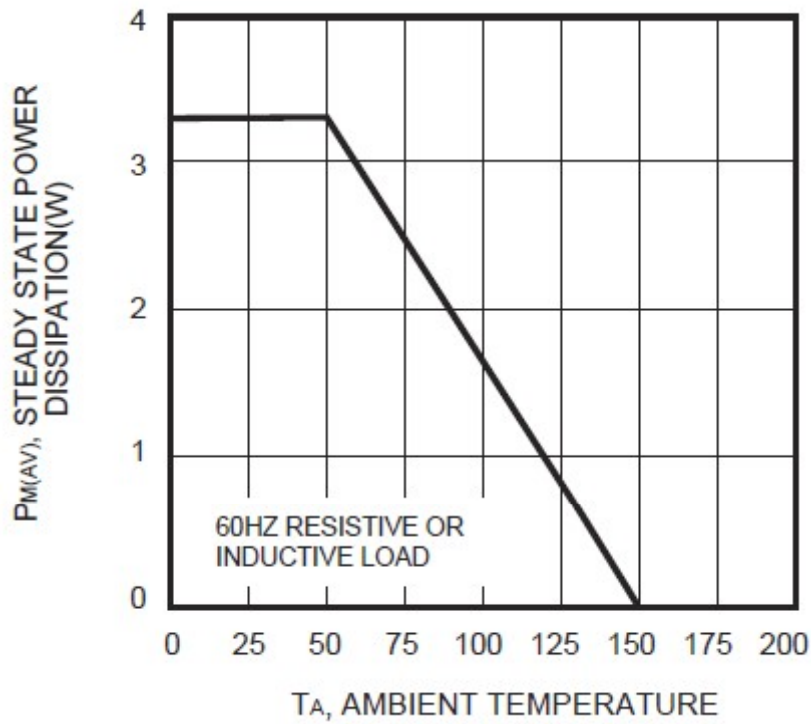

### Typical Junction Capacitance

SMAJ series

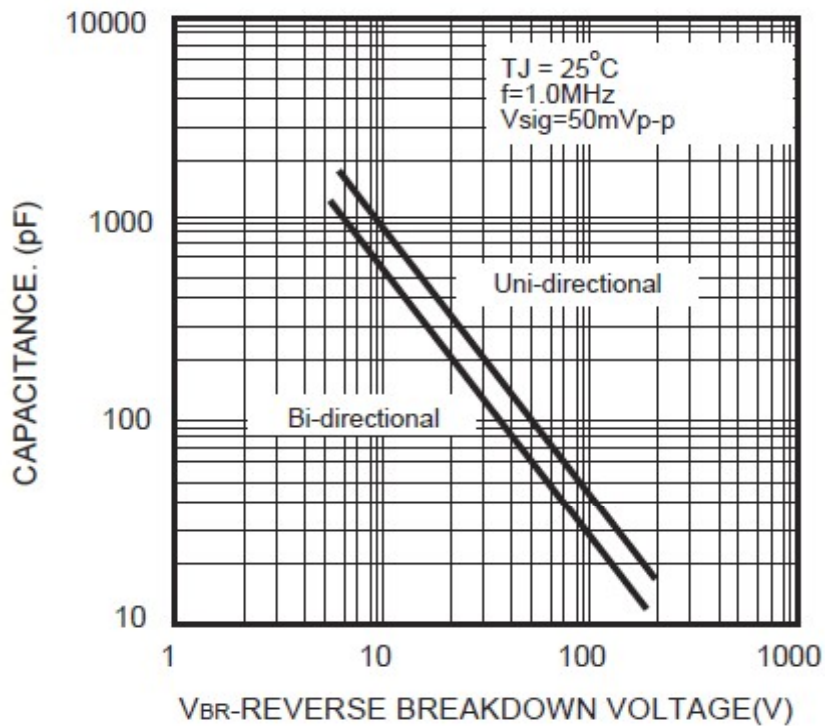

### RoHS Compliant Declaration

We hereby declare that the components delivered to your company are compliant with RoHS directive 2015/863/EU.

### Warehouse Storage Conditions of Products

(I) Storage Conditions :

- 1.Storage Temperature :  $-10^{\circ}\text{C} \sim +40^{\circ}\text{C}$
- 2.Relative Humidity :  $\leq 75\%RH$
- 3.Keep away from corrosive atmosphere and sunlight.

(II) Period of Storage : 1 year

## Safety Approvals



\* UL 497B recognized (File # E229991)

## Certificates

- (1) IATF 16949 certificate
- (2) ISO 9001 certificate

## Test Report

- (1) RoHS test report
- (2) Halogen-free test report