



THINKING ELECTRONIC INDUSTRIAL CO., LTD.

HEAD OFFICE: 12F, No.93, Dashun 1st Rd., Zuoying Dist., Kaohsiung, Taiwan
TEL: 886-7-5577660 FAX: 886-7-5570560

MANUFACTURING SITE

- KAOHSIUNG FACTORY 1: No. 51, Kaifa Rd., N.E.P.Z, Kaohsiung City 81170, Taiwan
TEL: 886-7-9616668 FAX: 886-7-9616698
- KAOHSIUNG FACTORY 2: No. 2-2, Xinjian S. Rd., N.E.P.Z., Kaohsiung City 81170, Taiwan
TEL: 886-7-9630001 FAX: 886-7-3635113
- CHANGZHOU FACTORY: No.6 Longmen Rd., Wujin High & New-Tech Industrial
Development Zone, Changzhou, Jiangsu, China 213161
TEL: 86-519-86578999 FAX: 86-519-86558643
- DONG GUAN FACTORY: No.45, East Rd., Sha-Tao Dist., Chang-An Town,
Dongguan City, Guangdong, China 523863
TEL: 86-769-85542016 FAX: 86-769-85546890
- YICHANG FACTORY: No. 283 Xiaoting Avenue, Xiaoting Dist., Yichang
City 443007, Hubei, China
TEL: 86-717-6510010 FAX: 86-717-6511430



SPECIFICATION FOR APPROVAL

CUSTOMER	立創電子
CERTIFIED MODEL/TYPE	P6SMB220
PART NO.	P6SMB220A (RoHS+HF)
APPLICATION	
CUSTOMER P/N	
ISSUE DATE	Dec.05,2020
REV. NO.	
REV. DATE	

FOR CUSTOMER APPROVAL	CHECKED BY
	<i>Dan Zhang</i>
	APPROVED BY
	<i>Huaifang Zhang</i>





REVISED RECORD SHEET

REV. NO	REV. DATE	REVISED CONTENT



INDEX	Page
■ Part Number Code	1
■ Structure and Dimensions	2
■ Electrical Characteristics	3 ~ 4
■ Reliability	5
■ Soldering Recommendation	6
■ Packaging	7
■ Pulse Waveform	8
■ Pulse Derating Curve	8
■ Peak Pulse Power Rating Curve	9
■ Steady State Power Derating Curve	10
■ Typical Junction Capacitance	11
■ RoHS Compliant Declaration	12
■ Warehouse Storage Conditions of Products	12
■ Safety Approvals & Certificates & Test Report	13



Part Number Code

P6SMB **220** **A**
(1) (2) (3)

No.	Item	Digit	Specification
(1)	Product Type	P6SMB	Thinking Power TVS SMD Type
(2)	Central of Breakage Voltage (V _{BR})	220	220=220 V _{BR}
(3)	Type Code	A	Uni-directional 5% V _{BR} Voltage Tolerance

Structure and Dimensions

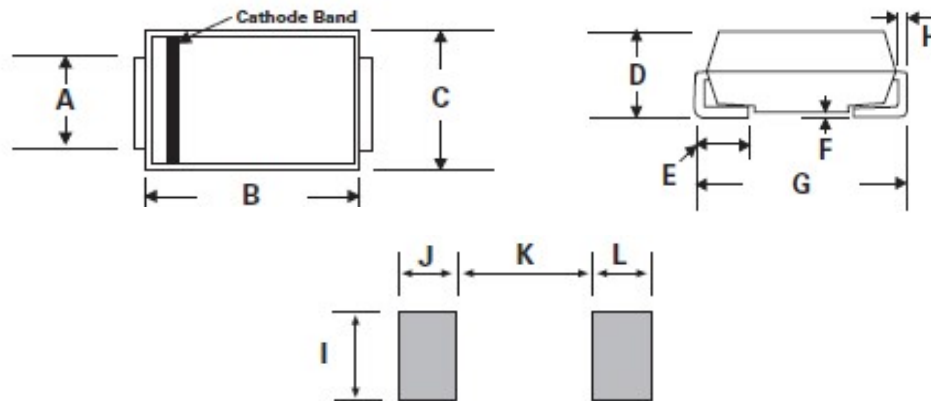

*The Cathode bend for Uni-directional product only.

Item	Millimeters		Inches	
	Min.	Max.	Min.	Max.
A	1.91	2.2	0.075	0.086
B	4.06	4.7	0.16	0.185
C	3.3	3.94	0.13	0.155
D	2.13	2.70	0.083	0.096
E	0.76	1.52	0.03	0.06
F	-	0.203	-	0.008
G	5.08	5.59	0.2	0.22
H	0.152	0.305	0.006	0.012
I	2.26	-	0.089	-
J/L	2.16	-	0.085	-
K	-	2.74	-	0.107

Electrical Characteristics

Peak power dissipation with a 10/1000 μ s waveform : 600W

Operating junction and storage temperature range : -55~+150 °C

Part No. (Uni)	Part No. (Bi)	Reverse Stand off Voltage	Breakage Voltage VBR @ IT		Test Current	Maximum Clamping Voltage VC @ Ipp	Maximum Peak Pulse Current	Maximum Reverse Leakage IR @VRWM	Marking Code	
			VRWM (V)	Min(V)					Max(V)	IT(mA)
P6SMB6.8A	P6SMB6.8CA	5.8	6.46	7.14	10	10.5	57.14	1000	6V8A.	6V8C.
P6SMB7.5A	P6SMB7.5CA	6.4	7.13	7.88	10	11.3	53.1	500	7V5A.	7V5C.
P6SMB8.2A	P6SMB8.2CA	7.02	7.79	8.61	10	12.1	49.59	200	8V2A.	8V2C.
P6SMB9.1A	P6SMB9.1CA	7.78	8.65	9.56	1	13.4	44.78	50	9V1A.	9V1C.
P6SMB10A	P6SMB10CA	8.55	9.5	10.5	1	14.5	41.38	10	10A.	10C.
P6SMB11A	P6SMB11CA	9.4	10.45	11.55	1	15.6	38.46	5	11A.	11C.
P6SMB12A	P6SMB12CA	10.2	11.4	12.6	1	16.7	35.93	5	12A.	12C.
P6SMB13A	P6SMB13CA	11.1	12.35	13.65	1	18.2	32.97	1	13A.	13C.
P6SMB15A	P6SMB15CA	12.8	14.25	15.75	1	21.2	28.3	1	15A.	15C.
P6SMB16A	P6SMB16CA	13.6	15.2	16.8	1	22.5	26.67	1	16A.	16C.
P6SMB18A	P6SMB18CA	15.3	17.1	18.9	1	25.5	23.81	1	18A.	18C.
P6SMB20A	P6SMB20CA	17.1	19	21	1	27.7	21.66	1	20A.	20C.
P6SMB22A	P6SMB22CA	18.8	20.9	23.1	1	30.6	19.61	1	22A.	22C.
P6SMB24A	P6SMB24CA	20.5	22.8	25.2	1	33.2	18.07	1	24A.	24C.
P6SMB27A	P6SMB27CA	23.1	25.65	28.35	1	37.5	16	1	27A.	27C.
P6SMB30A	P6SMB30CA	25.6	28.5	31.5	1	41.4	14.49	1	30A.	30C.
P6SMB33A	P6SMB33CA	28.2	31.35	34.65	1	45.7	13.13	1	33A.	33C.
P6SMB36A	P6SMB36CA	30.8	34.2	37.8	1	49.9	12.02	1	36A.	36C.
P6SMB39A	P6SMB39CA	33.3	37.05	40.95	1	53.9	11.13	1	39A.	39C.
P6SMB43A	P6SMB43CA	36.8	40.85	45.15	1	59.3	10.12	1	43A.	43C.
P6SMB47A	P6SMB47CA	40.2	44.65	49.35	1	64.8	9.26	1	47A.	47C.
P6SMB51A	P6SMB51CA	43.6	48.45	53.55	1	70.1	8.56	1	51A.	51C.
P6SMB56A	P6SMB56CA	47.8	53.2	58.8	1	77	7.79	1	56A.	56C.
P6SMB62A	P6SMB62CA	53	58.9	65.1	1	85	7.06	1	62A.	62C.
P6SMB68A	P6SMB68CA	58.1	64.6	71.4	1	92	6.52	1	68A.	68C.
P6SMB75A	P6SMB75CA	64.1	71.25	78.75	1	103	5.83	1	75A.	75C.
P6SMB82A	P6SMB82CA	70.1	77.9	86.1	1	113	5.31	1	82A.	82C.
P6SMB91A	P6SMB91CA	77.8	86.45	95.55	1	125	4.8	1	91A.	91C.
P6SMB100A	P6SMB100CA	85.5	95	105	1	137	4.38	1	100A.	100C.
P6SMB110A	P6SMB110CA	94	104.5	115.5	1	152	3.95	1	110A.	110C.
P6SMB120A	P6SMB120CA	102	114	126	1	165	3.64	1	120A.	120C.
P6SMB130A	P6SMB130CA	111	123.5	136.5	1	179	3.35	1	130A.	130C.
P6SMB150A	P6SMB150CA	128	142.5	157.5	1	207	2.9	1	150A.	150C.

Electrical Characteristics

Peak power dissipation with a 10/1000 μ s waveform : 600W

Operating junction and storage temperature range : -55~+150 °C

Part No. (Uni)	Part No. (Bi)	Reverse Stand off Voltage	Breakage Voltage VBR @ IT		Test Current	Maximum Clamping Voltage VC @ Ipp	Maximum Peak Pulse Current	Maximum Reverse Leakage IR @VRWM	Marking Code	
			VRWM (V)	Min(V)					Max(V)	IT(mA)
P6SMB160A	P6SMB160CA	136	152	168	1	219	2.74	1	160A.	160C.
P6SMB170A	P6SMB170CA	145	161.5	178.5	1	234	2.56	1	170A.	170C.
P6SMB180A	P6SMB180CA	154	171	189	1	246	2.44	1	180A.	180C.
P6SMB200A	P6SMB200CA	171	190	210	1	274	2.19	1	200A.	200C.
P6SMB220A	P6SMB220CA	185	209	231	1	328	1.83	1	220A.	220C.
P6SMB250A	P6SMB250CA	214	237.5	262.5	1	344	1.74	1	250A.	250C.
P6SMB300A	P6SMB300CA	256	285	315	1	414	1.45	1	300A.	300C.
P6SMB350A	P6SMB350CA	299.3	332.5	367.5	1	482	1.24	1	350A.	350C.
P6SMB380A	P6SMB380CA	324.9	361	399	1	524.4	1.14	1	380A.	380C.
P6SMB400A	P6SMB400CA	342	380	420	1	548	1.09	1	400A.	400C.
P6SMB440A	P6SMB440CA	376.2	418	462	1	607.2	0.99	1	440A.	440C.
P6SMB500A	P6SMB500CA	427.5	475	525	1	690	0.87	1	500A.	500C.
P6SMB520A	P6SMB520CA	444.6	494	546	1	717.6	0.84	1	520A.	520C.
P6SMB550A	P6SMB550CA	470.3	522.5	577.5	1	759	0.79	1	550A.	550C.
P6SMB600A	P6SMB600CA	513	570	630	1	828	0.72	1	600A.	600C.

Reliability

Item	Standard	Test conditions / Methods	Specifications
HTRB (High Temp. Reverse Bias Test)	MIL-STD-750D METHOD 1038.3 Method 103	Test Temp. : 150°C Duration 168 hrs with rated VRWM	Electrical properties meet Specifications
PCT (Pressure Cooker Test)	MIL-STD-19500 EAPPENDIX C	Test Temp. : 121 °C Pressure:1.2Kg Duration: 96 hrs	Electrical properties meet Specifications
TCT	MIL-STD-750D METHOD 1051.5	Test Temp. : -55°C ~+150°C 20 cycles	Electrical properties meet Specifications
Forward Surge	MIL-STD-750D METHOD 4066.3	Sine half wave 8.3mS 1 shot IFSM:20A forSMF 40A for SMA/ P4SMA & SMAF 100A for SMB/P6SMB 200A for SMC/1.5SMC For Uni-directional product only.	Electrical properties meet Specifications
Soldering Heat	MIL-STD-750D METHOD 2031.2	Test Temp. : 260°C Duration:10 sec 1cycle	Electrical properties meet Specifications

Soldering Recommendation

■ IR-reflow soldering profile



Reflow Condition	Lead-free assembly
Preheat -Temperature Min(Ts min) -Temperature Min(Ts max) -Time (min to max) (ts)	150°C 200°C 60 – 180 seconds
Average ramp up rate -Temperature Liquidus (TL) to peak	3°C/second max
Ts(max) to TL -Ramp-up Rate	3°C/second max.
Reflow -Temperature Liquidus (TL) -Time (tl)	217°C 60 – 150 seconds
Peak Temperature (TP)	260°C
Time within 5°C of actual peak Temperature(tp)	20 – 40 seconds
Ramp-down Rate	6°C/second max.
Time 25°C to peak Temperature(TP)	8 minutes max.
Do not exceed	260°C

Packaging

Taping Specification

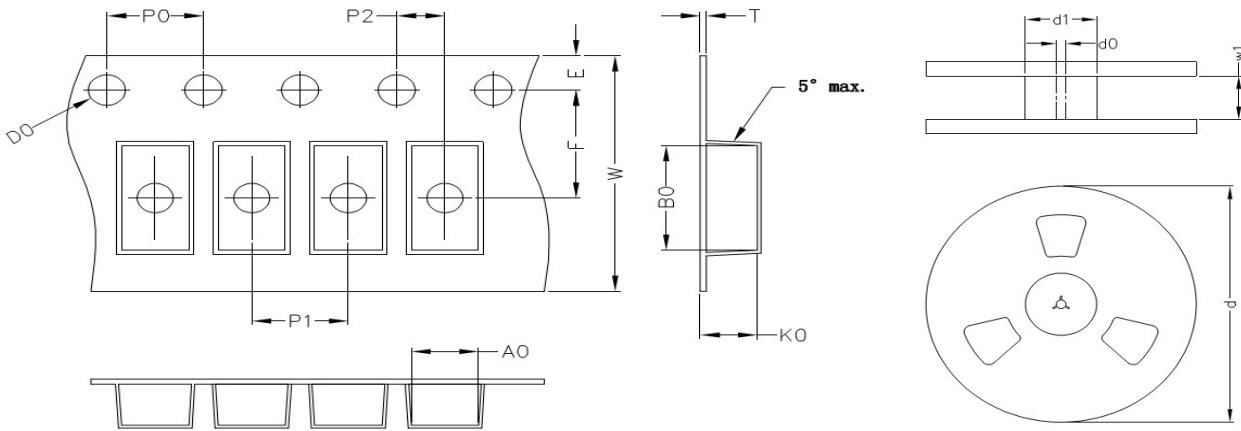

(Unit : mm)

Index	A0	B0	K0	D0	E	F	P0	P1	P2	T	W	d(13")	d1	d0	w1
P6SMB	3.65±0.1	5.6±0.1	2.57±0.1	1.55	1.75	5.5	4	8	2	0.25	12	330	75	13.5	13.5

Notes: The tolerance of carrier tape and top cover is ±0.1mm, the tolerance of reel is ±2mm

Quantity

Series Type	Reel size	Quantity (pcs/reel)
P6SMB	13"	3,000

Pulse Waveform

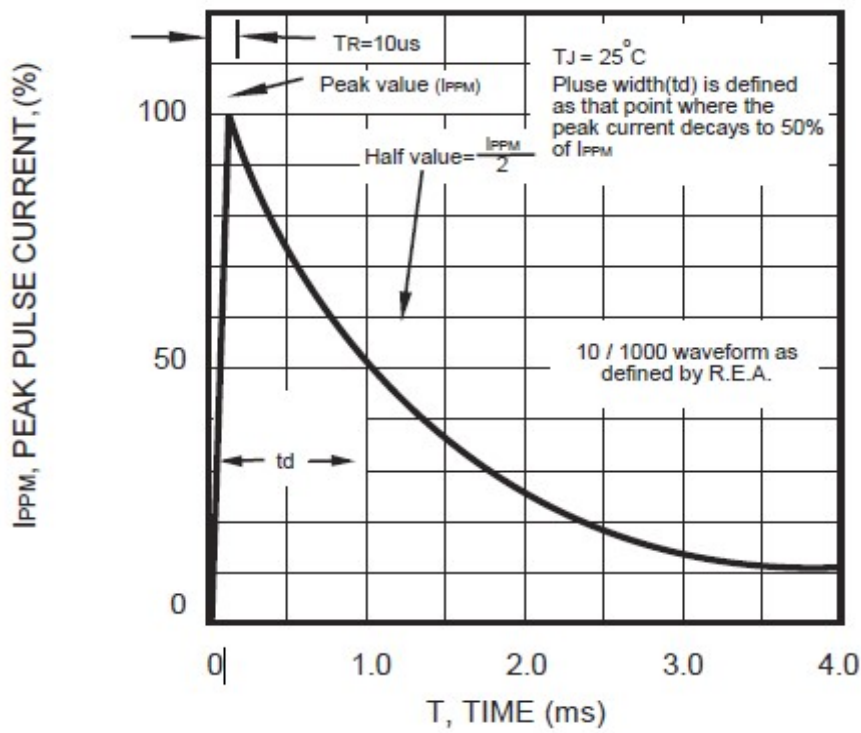

Pulse Derating Curve

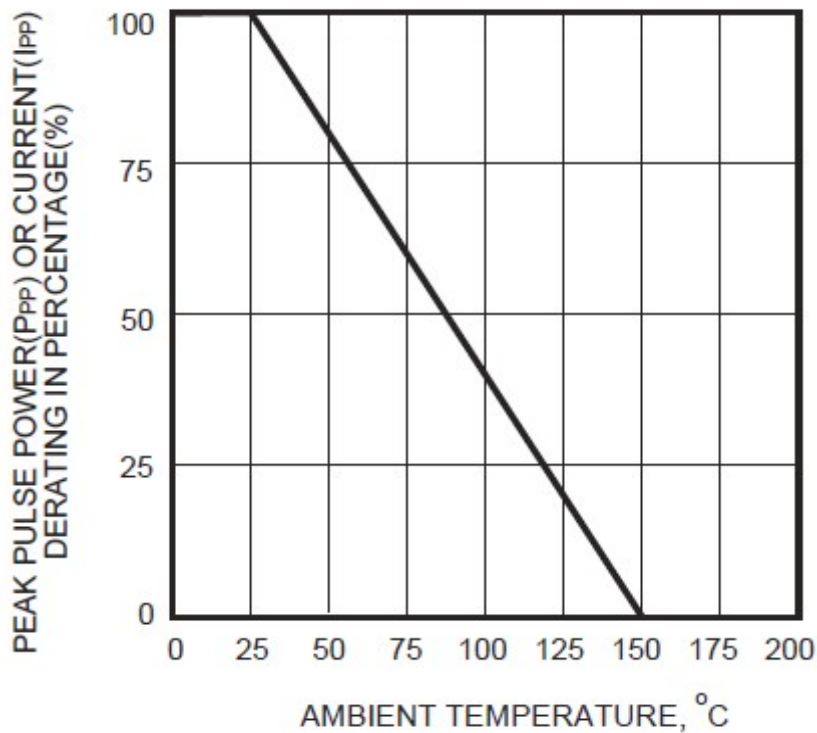

Peak Pulse Power Rating Curve

P6SMB series

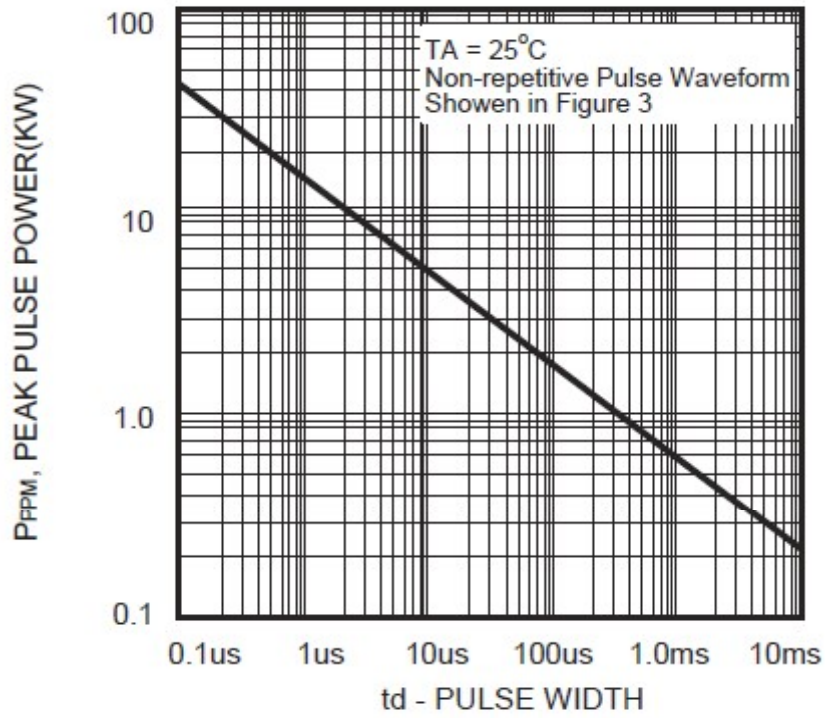

Steady State Power Derating Curve

P6SMB series

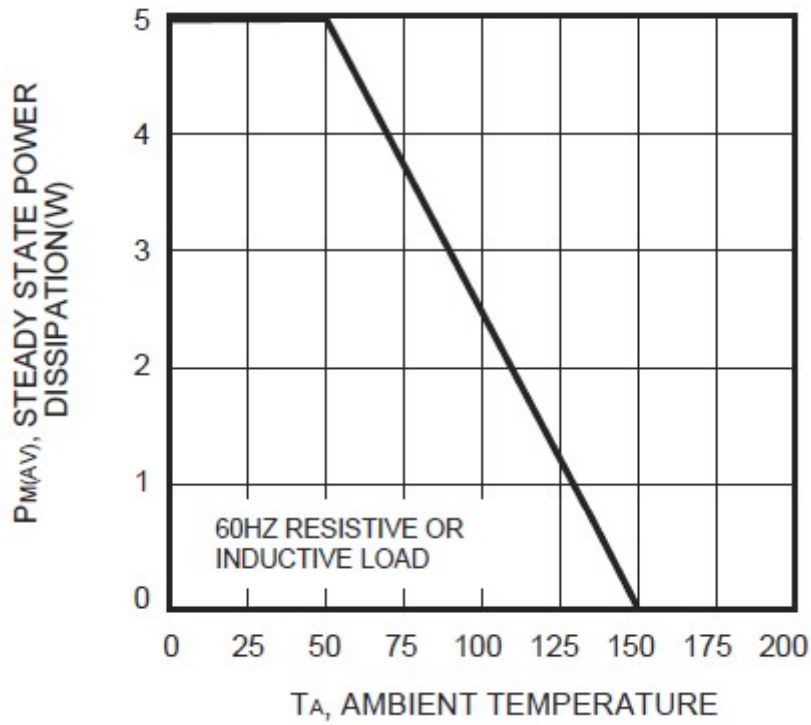

Typical Junction Capacitance

P6SMB series

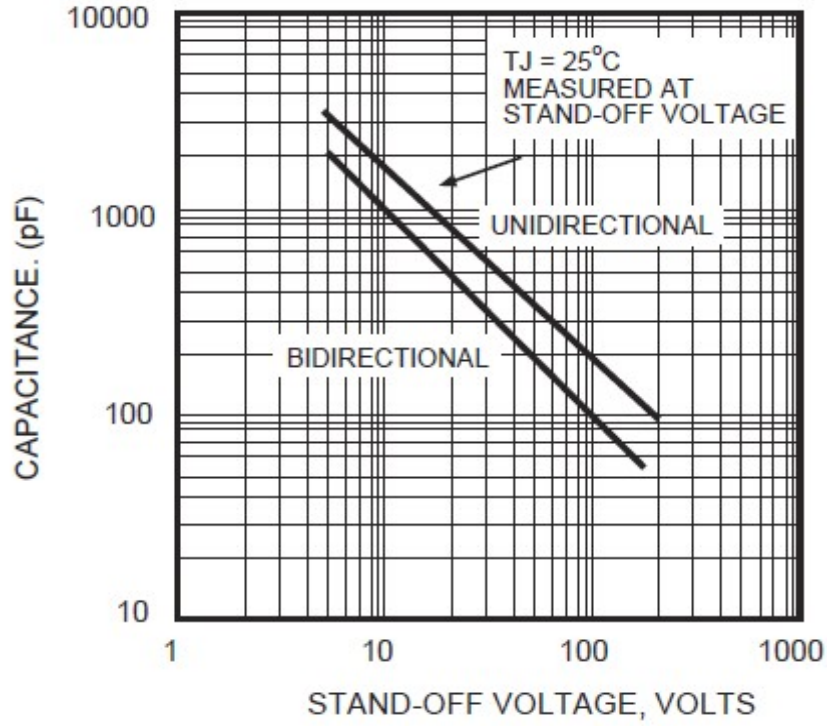

RoHS Compliant Declaration

We hereby declare that the components delivered to your company are compliant with RoHS directive 2015/863/EU.

Warehouse Storage Conditions of Products

(I) Storage Conditions :

- 1.Storage Temperature : $-10^{\circ}\text{C} \sim +40^{\circ}\text{C}$
- 2.Relative Humidity : $\leq 75\%RH$
- 3.Keep away from corrosive atmosphere and sunlight.

(II) Period of Storage : 1 year

Safety Approvals



* UL 497B recognized (File # E229991)

Certificates

- (1) IATF 16949 certificate
- (2) ISO 9001 certificate

Test Report

- (1) RoHS test report
- (2) Halogen-free test report