



THINKING ELECTRONIC INDUSTRIAL CO., LTD.

HEAD OFFICE: 12F, No.93, Dashun 1st Rd., Zuoying Dist., Kaohsiung, Taiwan

TEL: 886-7-5577660 FAX: 886-7-5570560

MANUFACTURING SITE

- KAOHSIUNG FACTORY 1: No. 51, Kaifa Rd., N.E.P.Z, Kaohsiung City 81170, Taiwan
TEL: 886-7-9616668 FAX: 886-7-9616698
- KAOHSIUNG FACTORY 2: No. 2-2, Xinjian S. Rd., N.E.P.Z., Kaohsiung City 81170, Taiwan
TEL: 886-7-9630001 FAX: 886-7-3635113
- CHANGZHOU FACTORY: No.6 Longmen Rd., Wujin High & New-Tech Industrial
Development Zone, Changzhou, Jiangsu, China 213161
TEL:86-519-86578999 FAX:86-519-86558643
- DONG GUAN FACTORY: No.45, East Rd., Sha-Tao Dist., Chang-An Town,
Dongguan City, Guangdong, China 523863
TEL:86-769-85542016 FAX:86-769-85546890
- YICHANG FACTORY: No. 283 Xiaoting Avenue, Xiaoting Dist., Yichang
City 443007, Hubei, China
TEL:86-717-6510010 FAX:86-717-6511430



SPECIFICATION FOR APPROVAL

CUSTOMER	立創電子
CERTIFIED MODEL/TYPE	P4SMA6.8
PART NO.	P4SMA6.8CA (RoHS+HF)
APPLICATION	
CUSTOMER P/N	
ISSUE DATE	Dec.05,2020
REV. NO.	
REV. DATE	

FOR CUSTOMER APPROVAL	CHECKED BY
	<i>Dan Zhang</i>
	APPROVED BY
	<i>Huafang Zhang</i>





REVISED RECORD SHEET

REV. NO	REV. DATE	REVISED CONTENT



INDEX	Page
■ Part Number Code	1
■ Structure and Dimensions	2
■ Electrical Characteristics	3 ~ 4
■ Reliability	5
■ Soldering Recommendation	6
■ Packaging	7
■ Pulse Waveform	8
■ Pulse Derating Curve	8
■ Peak Pulse Power Rating Curve	9
■ Steady State Power Derating Curve	10
■ Typical Junction Capacitance	11
■ RoHS Compliant Declaration	12
■ Warehouse Storage Conditions of Products	12
■ Safety Approvals & Certificates & Test Report	13



Part Number Code

P4SMA **6.8** **CA**
(1) (2) (3)

No.	Item	Digit	Specification
(1)	Product Type	P4SMA	Thinking Power TVS SMD Type
(2)	Central of Breakage Voltage (V _{BR})	6.8	6.8=6.8 V _{BR}
(3)	Type Code	CA	Bi-directional 5% VBR Voltage Tolerance

Structure and Dimensions

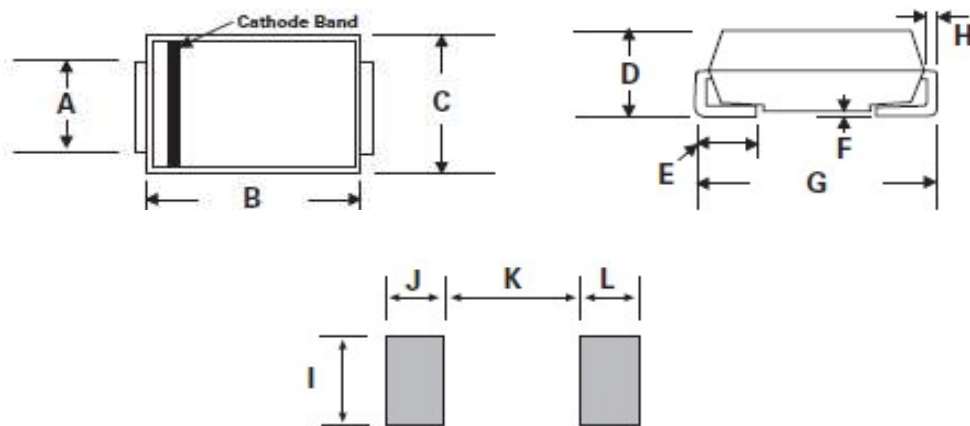

*The Cathode bend for Uni-directional product only.

Item	Millimeters		Inches	
	Min.	Max.	Min.	Max.
A	1.25	1.65	0.049	0.065
B	3.99	4.6	0.157	0.181
C	2.4	2.8	0.094	0.11
D	1.9	2.3	0.074	0.09
E	0.76	1.52	0.03	0.06
F	-	0.203	-	0.008
G	4.8	5.28	0.188	0.208
H	0.152	0.305	0.006	0.012
I	1.8	-	0.07	-
J/L	2.1	-	0.082	-
K	-	2.3	-	0.09

Electrical Characteristics

Peak power dissipation with a 10/1000µs waveform : 400W

Operating junction and storage temperature range : -55~+150 °C

Part No. (Uni)	Part No. (Bi)	Reverse Stand off Voltage	Breakage Voltage VBR @ IT		Test Current	Maximum Clamping Voltage VC @ Ipp	Maximum Peak Pulse Current	Maximum Reverse Leakage IR @VRWM	Marking Code	
			VRWM (V)	Min(V)					Max(V)	IT(mA)
P4SMA6.8A	P4SMA6.8CA	5.8	6.46	7.14	10	10.5	38.1	1000	6V8A.	6V8C.
P4SMA7.5A	P4SMA7.5CA	6.4	7.13	7.88	10	11.3	35.4	500	7V5A.	7V5C.
P4SMA8.2A	P4SMA8.2CA	7	7.79	8.61	10	12.1	33.06	200	8V2A.	8V2C.
P4SMA9.1A	P4SMA9.1CA	7.78	8.65	9.56	1	13.4	29.85	50	9V1A.	9V1C.
P4SMA10A	P4SMA10CA	8.55	9.5	10.5	1	14.5	27.59	10	10A.	10C.
P4SMA11A	P4SMA11CA	9.4	10.45	11.55	1	15.6	25.64	5	11A.	11C.
P4SMA12A	P4SMA12CA	10.2	11.4	12.6	1	16.7	23.95	5	12A.	12C.
P4SMA13A	P4SMA13CA	11.1	12.35	13.65	1	18.2	21.98	1	13A.	13C.
P4SMA15A	P4SMA15CA	12.8	14.25	15.75	1	21.2	18.87	1	15A.	15C.
P4SMA16A	P4SMA16CA	13.6	15.2	16.8	1	22.5	17.78	1	16A.	16C.
P4SMA18A	P4SMA18CA	15.3	17.1	18.9	1	25.5	15.87	1	18A.	18C.
P4SMA20A	P4SMA20CA	17.1	19	21	1	27.7	14.44	1	20A.	20C.
P4SMA22A	P4SMA22CA	18.8	20.9	23.1	1	30.6	13.07	1	22A.	22C.
P4SMA24A	P4SMA24CA	20.5	22.8	25.2	1	33.2	12.05	1	24A.	24C.
P4SMA27A	P4SMA27CA	23.1	25.65	28.35	1	37.5	10.67	1	27A.	27C..
P4SMA30A	P4SMA30CA	25.6	28.5	31.5	1	41.4	9.66	1	30A.	30C..
P4SMA33A	P4SMA33CA	28.2	31.35	34.65	1	45.7	8.75	1	33A.	33C..
P4SMA36A	P4SMA36CA	30.8	34.2	37.8	1	49.9	8.02	1	36A.	36C..
P4SMA39A	P4SMA39CA	33.3	37.05	40.95	1	53.9	7.42	1	39A.	39C.
P4SMA43A	P4SMA43CA	36.8	40.85	45.15	1	59.3	6.75	1	43A.	43C.
P4SMA47A	P4SMA47CA	40.2	44.65	49.35	1	64.8	6.17	1	47A.	47C.
P4SMA51A	P4SMA51CA	43.6	48.45	53.55	1	70.1	5.71	1	51A.	51C.
P4SMA56A	P4SMA56CA	47.8	53.2	58.8	1	77	5.19	1	56A.	56C.
P4SMA62A	P4SMA62CA	53	58.9	65.1	1	85	4.71	1	62A.	62C.
P4SMA68A	P4SMA68CA	58.1	64.6	71.4	1	92	4.35	1	68A.	68C.
P4SMA75A	P4SMA75CA	64.1	71.25	78.75	1	103	3.88	1	75A.	75C.
P4SMA82A	P4SMA82CA	70.1	77.9	86.1	1	113	3.54	1	82A.	82C.
P4SMA91A	P4SMA91CA	77.8	86.45	95.55	1	125	3.2	1	91A.	91C.
P4SMA100A	P4SMA100CA	85.5	95	105	1	137	2.92	1	100A.	100C.
P4SMA110A	P4SMA110CA	94	104.5	115.5	1	152	2.63	1	110A.	110C.
P4SMA120A	P4SMA120CA	102	114	126	1	165	2.42	1	120A.	120C.
P4SMA130A	P4SMA130CA	111	123.5	136.5	1	179	2.23	1	130A.	130C.
P4SMA150A	P4SMA150CA	128	142.5	157.5	1	207	1.93	1	150A.	150C.

Electrical CharacteristicsPeak power dissipation with a 10/1000 μ s waveform : 400W

Operating junction and storage temperature range : -55~+150 °C

Part No. (Uni)	Part No. (Bi)	Reverse Stand off Voltage	Breakage Voltage VBR @ IT		Test Current	Maximum Clamping Voltage VC @ Ipp	Maximum Peak Pulse Current	Maximum Reverse Leakage IR @VRWM	Marking Code	
			VRWM (V)	Min(V)					Max(V)	IT(mA)
P4SMA160A	P4SMA160CA	136	152	168	1	219	1.83	1	160A.	160C.
P4SMA170A	P4SMA170CA	145	161.5	178.5	1	234	1.71	1	170A.	170C.
P4SMA180A	P4SMA180CA	154	171	189	1	246	1.63	1	180A.	180C.
P4SMA200A	P4SMA200CA	171	190	210	1	274	1.46	1	200A.	200C.
P4SMA220A	P4SMA220CA	185	209	231	1	328	1.22	1	220A.	220C.
P4SMA250A	P4SMA250CA	214	237.5	262.5	1	344	1.16	1	250A.	250C.
P4SMA300A	P4SMA300CA	256	285	315	1	414	0.97	1	300A.	300C.
P4SMA350A	P4SMA350CA	299.3	332.5	367.5	1	482	0.83	1	350A.	350C.
P4SMA380A	P4SMA380CA	324.9	361	399	1	524.4	0.76	1	380A.	380C.
P4SMA400A	P4SMA400CA	342	380	420	1	552	0.72	1	400A.	400C.
P4SMA440A	P4SMA440CA	376.2	418	462	1	607.2	0.66	1	440A.	440C.
P4SMA500A	P4SMA500CA	427.5	475	525	1	690	0.58	1	500A.	500C.
P4SMA520A	P4SMA520CA	444.6	494	546	1	717.6	0.56	1	520A.	520C.
P4SMA550A	P4SMA550CA	470.3	522.5	577.5	1	759	0.53	1	550A.	550C.
P4SMA600A	P4SMA600CA	513	570	630	1	828	0.48	1	600A.	600C.

Reliability

Item	Standard	Test conditions / Methods	Specifications
HTRB (High Temp. Reverse Bias Test)	MIL-STD-750D METHOD 1038.3 Method 103	Test Temp. : 150°C Duration 168 hrs with rated VRWM	Electrical properties meet Specifications
PCT (Pressure Cooker Test)	MIL-STD-19500 EAPPENDIX C	Test Temp. : 121 °C Pressure:1.2Kg Duration: 96 hrs	Electrical properties meet Specifications
TCT	MIL-STD-750D METHOD 1051.5	Test Temp. : -55°C ~+150°C 20 cycles	Electrical properties meet Specifications
Forward Surge	MIL-STD-750D METHOD 4066.3	Sine half wave 8.3mS 1 shot IFSM:20A forSMF 40A for SMA/ P4SMA & SMAF 100A for SMB/P6SMB 200A for SMC/1.5SMC For Uni-directional product only.	Electrical properties meet Specifications
Soldering Heat	MIL-STD-750D METHOD 2031.2	Test Temp. : 260°C Duration:10 sec 1cycle	Electrical properties meet Specifications

Soldering Recommendation

■ IR-reflow soldering profile



Reflow Condition	Lead-free assembly
Preheat -Temperature Min(Ts min) -Temperature Min(Ts max) -Time (min to max) (ts)	150°C 200°C 60 – 180 seconds
Average ramp up rate -Temperature Liquidus (TL) to peak	3°C/second max
Ts(max) to TL -Ramp-up Rate	3°C/second max.
Reflow -Temperature Liquidus (TL) -Time (tL)	217°C 60 – 150 seconds
Peak Temperature (TP)	260°C
Time within 5°C of actual peak Temperature(tp)	20 – 40 seconds
Ramp-down Rate	6°C/second max.
Time 25°C to peak Temperature(TP)	8 minutes max.
Do not exceed	260°C

Packaging

Taping Specification

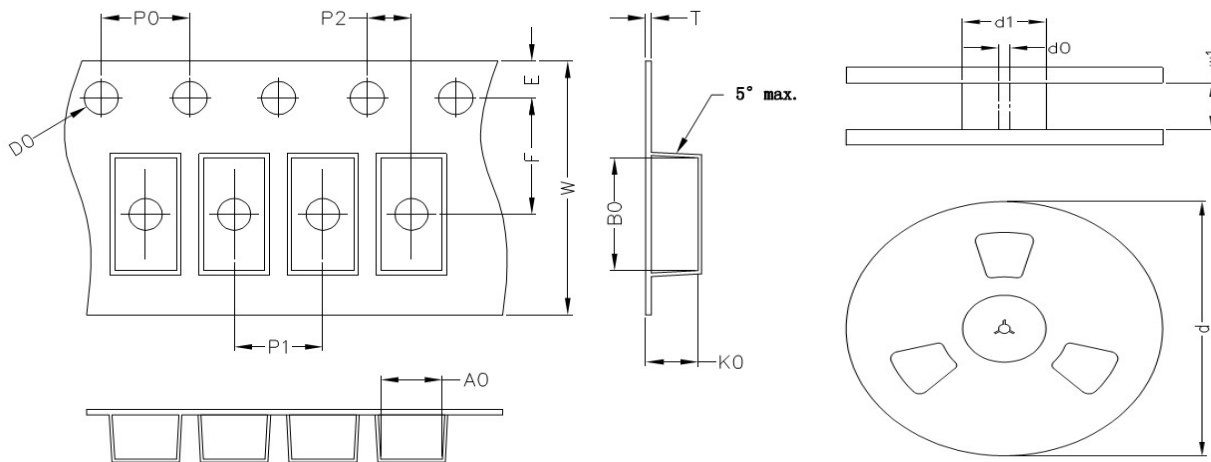

(Unit : mm)

Index	A0	B0	K0	D0	E	F	P0	P1	P2	T	W	d(13")	d1	d0	w1
P4SMA	2.8	5.33	2.36	1.55	1.75	5.5	4	4	2	0.22±0.05	12	330	75	13.5	13.5

Notes: The tolerance of carrier tape and top cover is ±0.1mm, the tolerance of reel is ±2mm

Quantity

Series Type	Reel size	Quantity (pcs/reel)
P4SMA	13"	5,000

Pulse Waveform

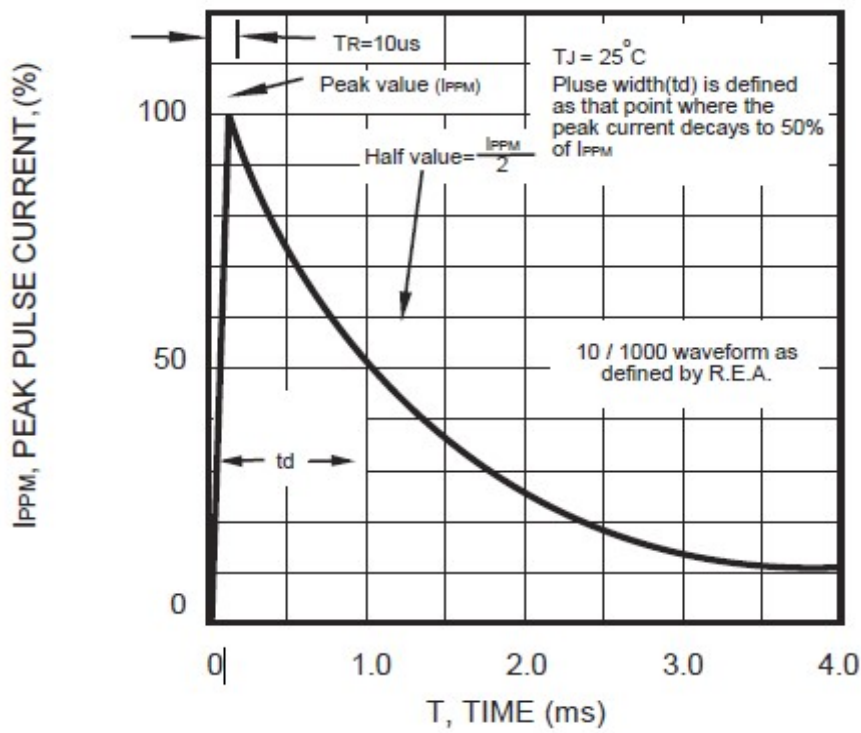

Pulse Derating Curve

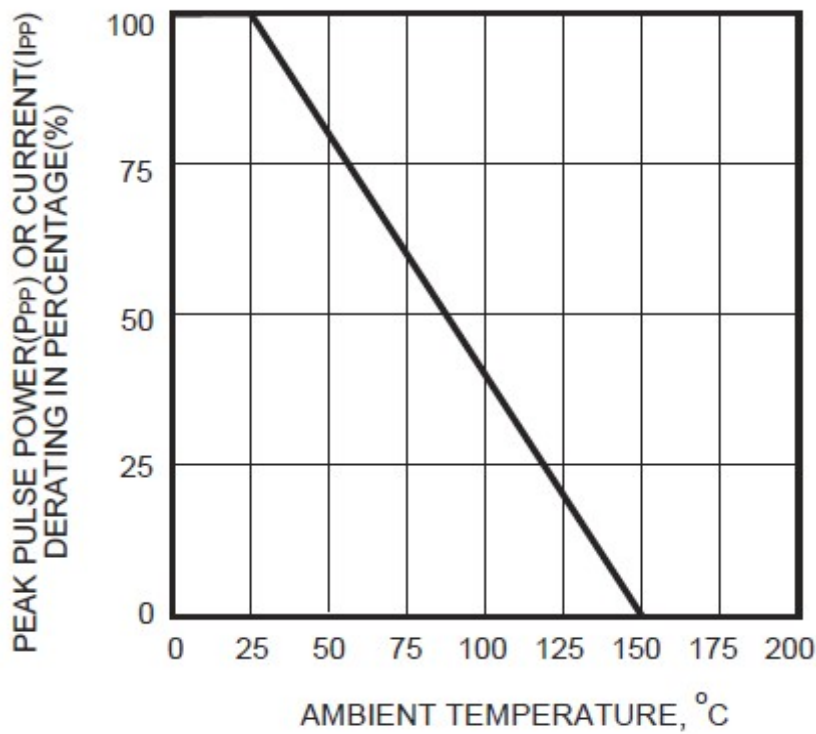

Peak Pulse Power Rating Curve

P4SMA series

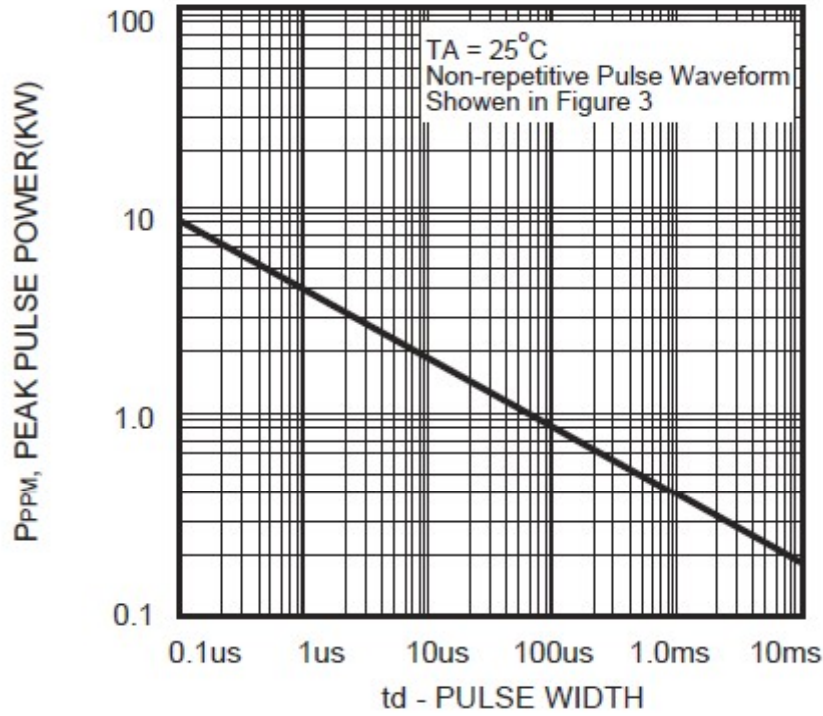

Steady State Power Derating Curve

P4SMA series

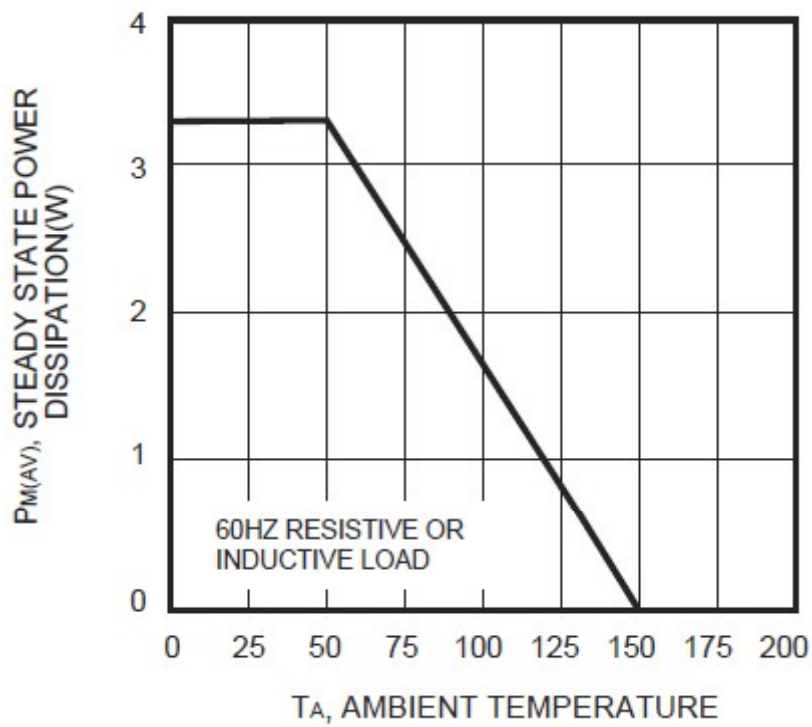

Typical Junction Capacitance

P4SMA series

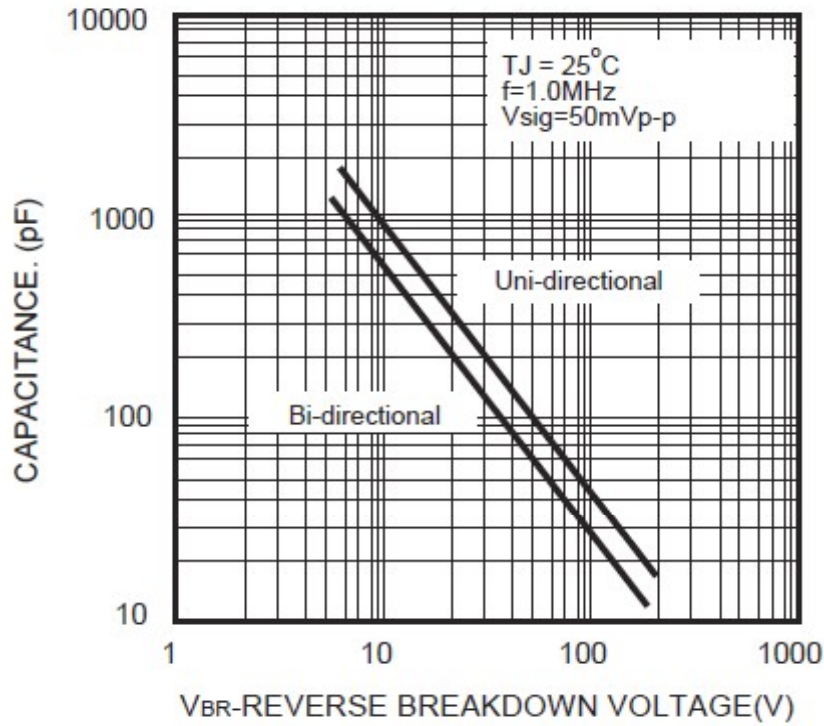

RoHS Compliant Declaration

We hereby declare that the components delivered to your company are compliant with RoHS directive 2015/863/EU.

Warehouse Storage Conditions of Products

(I) Storage Conditions :

- 1.Storage Temperature : $-10^{\circ}\text{C} \sim +40^{\circ}\text{C}$
- 2.Relative Humidity : $\leq 75\%RH$
- 3.Keep away from corrosive atmosphere and sunlight.

(II) Period of Storage : 1 year

Safety Approvals



* UL 497B recognized (File # E229991)

Certificates

- (1) IATF 16949 certificate
- (2) ISO 9001 certificate

Test Report

- (1) RoHS test report
- (2) Halogen-free test report