

12	13	14	15
MAPX	MODIFICATION	DATE	DRAW

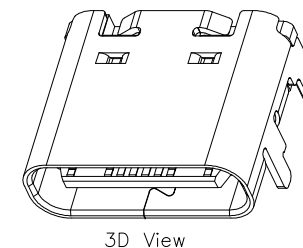

3D View

PIN DEFINE TABLE			
PIN	SIGNAL	PIN	SIGNAL
A12	GND	B1	GND
A11		B2	
A10		B3	
A9	VBUS	B4	VBUS
A8	SBU1	B5	CC2
A7	D-	B6	D+
A6	D+	B7	D-
A5	CC1	B8	SBU2
A4	VBUS	B9	VBUS
A3		B10	
A2		B11	
A1	GND	B12	GND

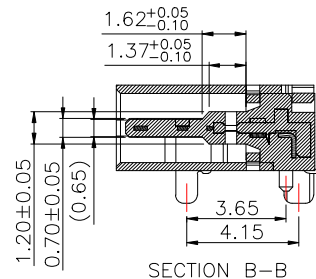
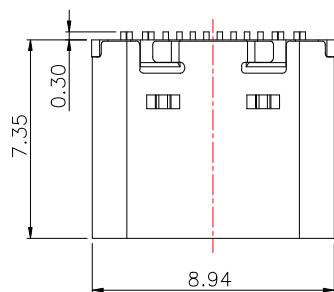
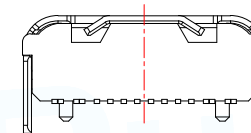
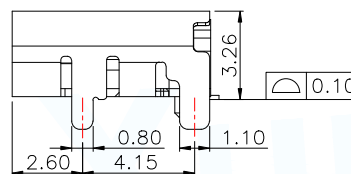
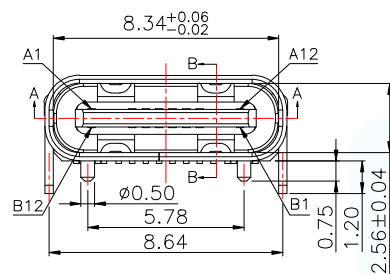

SPECIFICATION:

- Material:
 - HOUSING&MOLDING:LCP,UL94 V-0
 - CONTACTS:COPPER ALLOY T=0.20mm
 - MIDDLE CLIP:SUS301-1/2H,T=0.15mm
 - SHELL:SUS, T=0.30mm
- Mechanical:
 - 2.1.Mating force:5~20Nf Max.;
 - 2.2.Unmating force:6~20Nf Min.;
 - 2.3.Durability:10000 Cycles;
- Electrical:
 - 3.1.Current Rating:3A Max.;
 - 3.2.Voltage Rating:20V Max.;
 - 3.3.Dielectric Withstanding voltage:100VAc;
 - 3.4.Contact resistance:40m Ohms Max.;
 - 3.5.Insulation Resistance:100M Ohms Min.;
- Environmental:
 - 4.1.Operating temperature:-40°C~+85°C;
 - 4.2.Wetting Temperature:265±5°C,5±0.5s

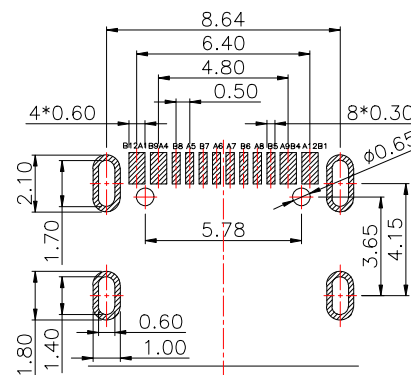
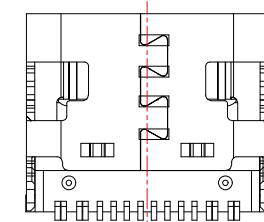

(TOP VIEW)
 RECOMMENDED P.C.B. LAYOUT (T:1.0~1.2mm)
 TOLERANCE UNSPECIFIED ±0.05mm

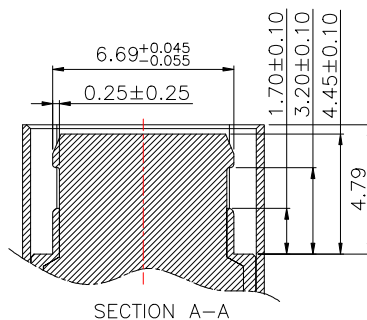

MANUFACTURE DWG			东莞市讯普电子科技有限公司 DongGuan XunPu Electronics Co.,Ltd	
UNLESS OTHERWISE SPECIFIED TOLERANCES			TITLE: TYPE-C 16pin母座板上型带塑胶柱	
DECIMALS:	ANGLES:	PAR	TYPEC-304-BCP16	
.X:±0.35	.X':±3.0°	DWN		
.XX:±0.25	.XX':±2.5°	CHKD		
.XXX:±0.15	.XXX':±2.0°	APVD		
CUSTOMER COPY		SCALE1:1	UNIT:MM	⊕
		SIZE:A4	SHEET:1F1	REV:A

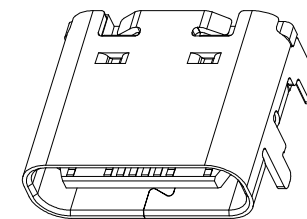
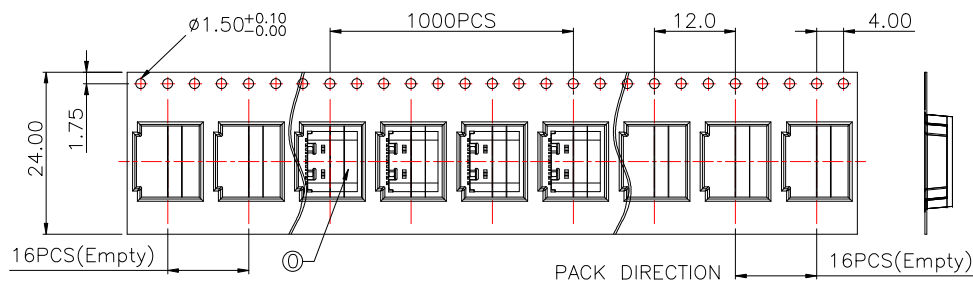

3D View

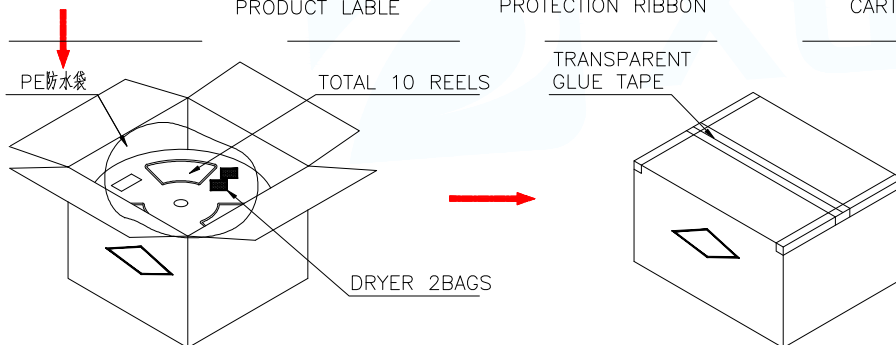
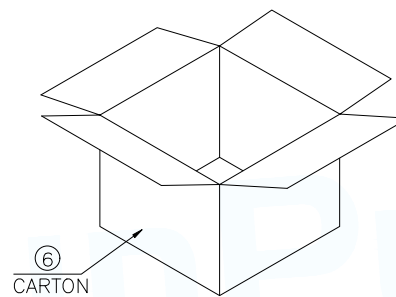
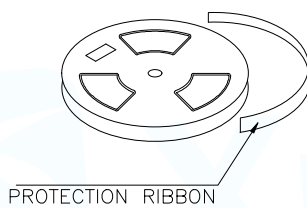
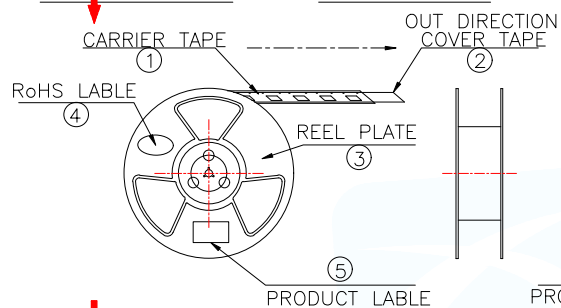

说明:

1. 每卷前后各空 16PCS,尾部用美纹胶纸封住;
2. 将产品放满盘后,再卷一圈保护带,用美纹胶纸将其封住,并贴上 1Pcs 物料标签;
3. 每 10 卷盘一叠共 10000Pcs 并装入 1 个外箱内;
4. 在搬运过程中要轻拿轻放;
5. 在运输中不可堆放过多(1.8M 最高),不可重压;
6. 跌落测试条件:
成品箱从 1.2 米高度自由落体(一角三棱六面):
a. 产品不可跑出下带凹槽;
b. 产品不可有摔伤,变形;
c. 内包装材料不可严重破损.

NO.	NAME	SPEC	Q'TY
①	TYPE C RECEPTACLE		10000PCS/CARTON
①	CARRIER TAPE	W=24mm,T=0.35mm	1000PCS/PLATE
②	COVER TAPE	W=21.5mm	10PLATES/CARTON
③	REEL PLATE	φ330*100*24.4mm	10PCS/CARTON
④	RoHS LABEL		10PCS/CARTON
⑤	PRODUCT LABER		10PCS/CARTON
⑥	CARTON	350*340*310mm	1PCS/PACKAGE

MANUFACTURE DWG			东莞市讯普电子科技有限公司 DongGuan XunPu Electronics Co.,Ltd	
UNLESS OTHERWISE SPECIFIED TOLERANCES			TITLE: TYPE-C 16pin 母座板上型带塑胶柱	
DECIMALS:	ANGLES:		PAR	TYPEC-304-BCP16
.X:±0.50	.X':±3.5'		DWN	
.XX:±0.30	.XX':±2.5'	CHKD		
.XXX:±0.15	.XXX':±1.5'	APVD		
CUSTOMER COPY		SCALE 1:1	UNIT:MM	
		SIZE:A4	SHEET:1F1	REV:A