

Features

- 150 Watts peak pulse power ($t_p = 8/20\mu s$)
- Transient protection for high speed data lines to
- IEC 61000-4-2 (ESD) $\pm 30kV$ (air), $\pm 30kV$ (contact)
- IEC 61000-4-4 (EFT) 40A(5/50ns)
- Protects One Power or I/O Port
- Low leakage current
- Low operating and clamping voltages
- Solid-state silicon avalanche technology

Mechanical Characteristics

- Package: SOD-523
- Lead Finish: Matte Tin
- Case Material: "Green" Molding Compound.
- UL Flammability Classification Rating 94V-0
- Moisture Sensitivity: Level 3 per J-STD-020
- Terminal Connections: See Diagram Below

Applications

- Cellular Handsets and Accessories
- Personal Digital Assistants
- Notebooks and Handhelds
- Portable Instrumentation
- Digital Cameras
- Peripherals
- Audio Players
- Keypads, Side Keys, LCD Displays, USB2.0

Ordering Information

Part Number	Qty per Reel	Reel Size
ESD3V3D5	3000	7"

Dimensions and Pin Configuration

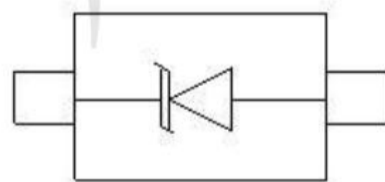

SOD-523 (Top View)

Absolute Maximum Ratings ($T_A=25^\circ\text{C}$ unless otherwise specified)

Parameter	Symbol	Value	Unit
ESD per IEC 61000-4-2 (Air)	VESD	±30	kV
ESD per IEC 61000-4-2 (Contact)		±30	
Operating Temperature Range	T _J	-55 to +125	°C
Storage Temperature Range	T _{stg}	-55 to +150	°C

Electrical Characteristics ($T_A=25^\circ\text{C}$ unless otherwise specified)

Symbol	Parameter
I _{PP}	Maximum Reverse Peak Pulse Current
V _C	Clamping Voltage @ I _{PP}
V _{RWM}	Working Peak Reverse Voltage
I _R	Maximum Reverse Leakage Current @ V _{RWM}
V _{BR}	Breakdown Voltage @ I _T
I _T	Test Current
I _F	Forward Current
V _F	Forward Voltage @ I _F
P _{pk}	Peak Power Dissipation
C	Capacitance @ V _R = 0 and f = 1.0 MHz

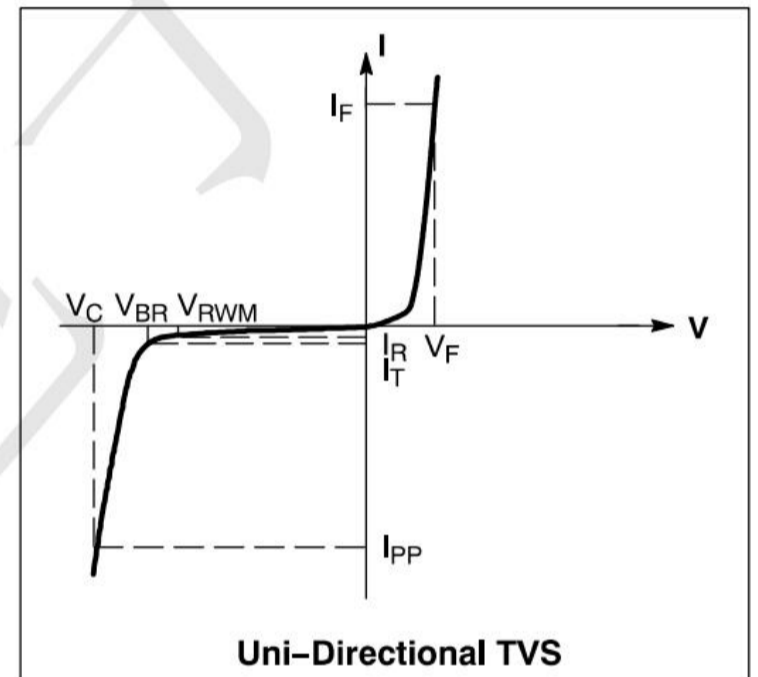

Parameter	Symbol	Min	Typ	Max	Unit	Test Condition
Reverse Working Voltage	V _{RWM}			3.3	V	
Breakdown Voltage	V _{BR}	5			V	I _T = 1mA
Reverse Leakage Current	I _R			0.2	uA	V _{RWM} = 5V
Clamping Voltage	V _C			9	V	I _{PP} = 1A (8 x 20μs pulse)
Clamping Voltage	V _C			14	V	I _{PP} = 11A (8 x 20μs pulse)
Junction Capacitance	C _J			110	pF	V _R = 0V, f = 1MHz

Characteristic Curves

Fig1. 8/20 μ s Pulse Waveform

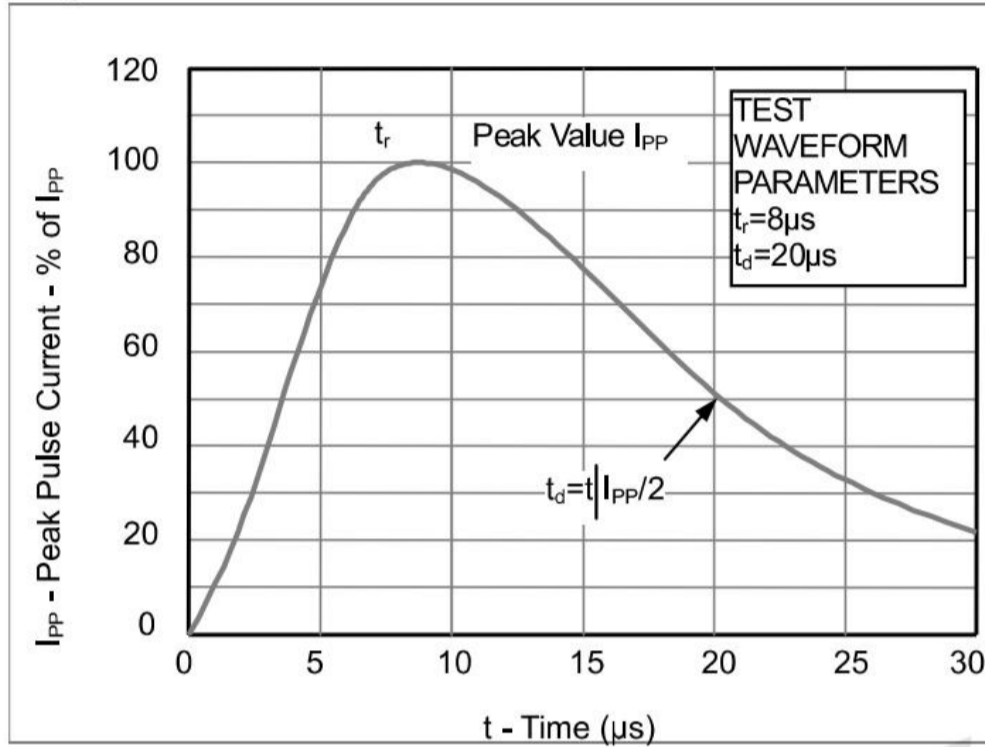

Fig2. ESD Pulse Waveform (according to IEC 61000-4-2)

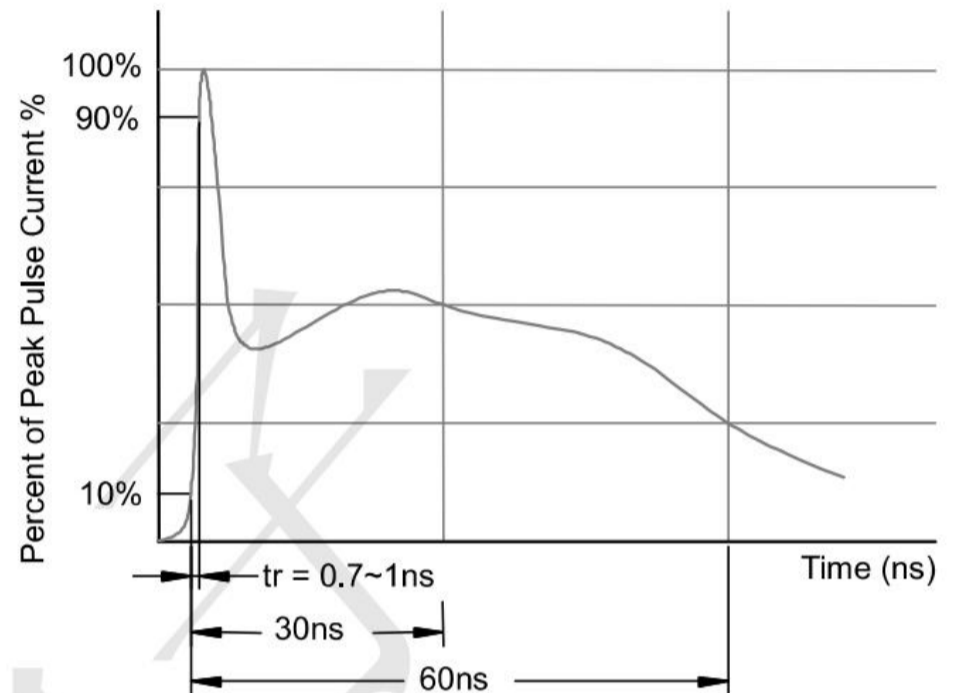
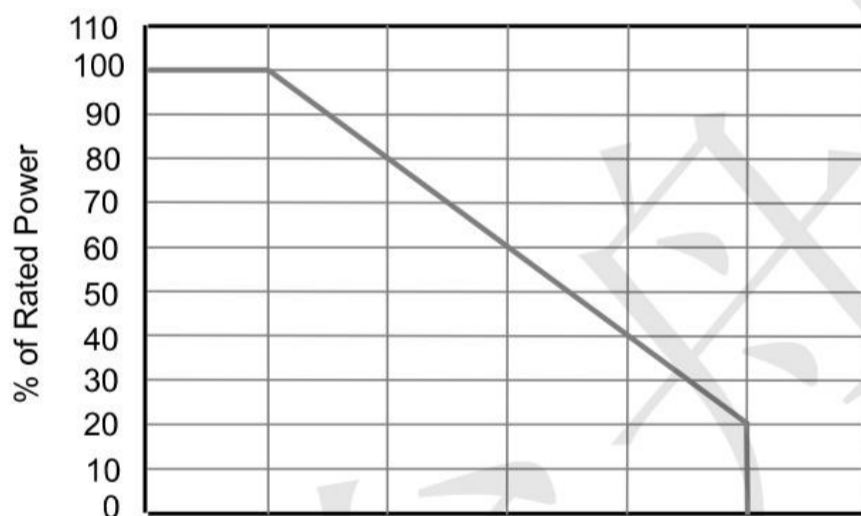
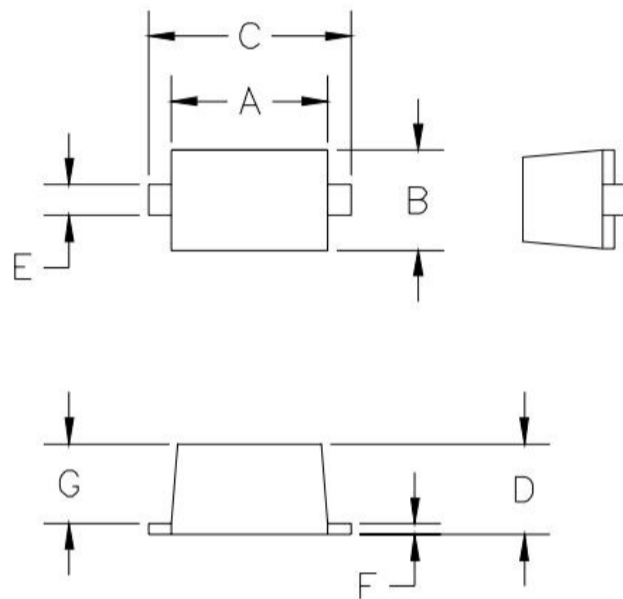

Fig3. Power Derating Curve



SOD-523 Package Outline Drawing



DIM ^N	INCHES		MM [1]		NOTE
	MIN	MAX	MIN	MAX	
A	.043	.051	1.10	1.30	—
B	.028	.035	0.70	0.90	—
C	.059	.067	1.50	1.70	—
D	.020	.028	0.50	0.70	—
E	.010	.014	0.25	0.35	—
F	.004	.008	0.10	0.20	—
G	.020	.028	0.50	0.70	—

[1] CONTROLLING DIMENSION: MILLIMETERS

Suggested Land Pattern

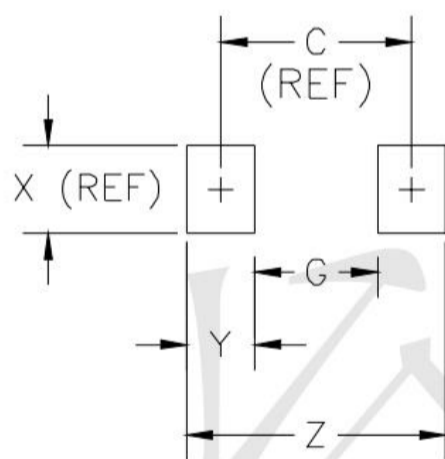

DIM ^N	INCHES		MM [1]		NOTE
	MIN	MAX	MIN	MAX	
C	—	.067	—	1.70	REF
G	—	.043	—	1.10	—
X	—	.031	—	0.80	REF
Y	—	.024	—	0.60	—
Z	—	.091	—	2.30	—

[1] CONTROLLING DIMENSION: MILLIMETERS