

Chip resistor networks

MNR35 (3216×5 size)

●Features

- 1) Common terminals yield area 40% smaller than that of the MNR38.
- 2) 8-element construction makes the MNR35 ideal for bus line pull-up / pull-down.
- 3) Convex electrodes
Easy to check the fillet after soldering is finished.
- 4) Compatible with a wide range of mounting equipment.
Squared corners make it excellent for mounting using image recognition devices.
- 5) ROHM resistors have approved ISO-9001 certification.
Design and specifications are subject to change without notice. Carefully check the specification sheet supplied with the product before using or ordering it.

●Ratings

Item	Conditions	Specifications	
Rated power	Power must be derated according to the power derating curve in Figure 1 when ambient temperature exceeds 70°C.  Fig.1	0.063W (1 / 16W) at 70°C	
Rated voltage	The voltage rating is calculated by the following equation. If the value obtained exceeds the limiting element voltage, the voltage rating is equal to the maximum operating voltage. $E = \sqrt{P \times R}$ E: Rated voltage (V) P: Rated power (W) R: Nominal resistance (Ω)	Limiting element voltage	50V
Nominal resistance	See Table 1.		
Operating temperature		-55°C~+125°C	

Table 1

Resistance tolerance	Resistance range (Ω)	Resistance temperature coefficient (ppm / °C)
J (±5%)	56≤R≤100k (E12)	±200

●Before using components in circuits where they will be exposed to transients such as pulse loads (short-duration, high-level loads), be certain to evaluate the component in the mounted state. In addition, the reliability and performance of this component cannot be guaranteed if it is used with a steady state voltage that is greater than its rated voltage.

Resistors

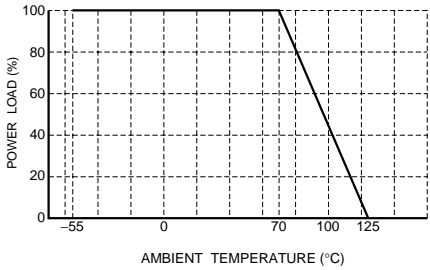
●Characteristics

Item	Guaranteed value	Test conditions (JIS C 5201-1)
	Resistor type	
Resistance	J : $\pm 5\%$	JIS C 5201-1 4.5
Variation of resistance with temperature	See <u>Table.1</u>	JIS C 5201-1 4.8 Measurement : $-55 / +25 / +125^{\circ}\text{C}$
Overload	$\pm (2.0\%+0.1\Omega)$	JIS C 5201-1 4.13 Rated voltage (current) $\times 2.5$, 2s. Limiting Element Voltage $\times 2$: 100V
Solderability	A new uniform coating of minimum of 95% of the surface being immersed and no soldering damage.	JIS C 5201-1 4.17 Rosin-Ethanol (25%WT) Soldering condition : $235\pm 5^{\circ}\text{C}$ Duration of immersion : $2.0\pm 0.5\text{s}$.
Resistance to soldering heat	$\pm (1.0\%+0.05\Omega)$ No remarkable abnormality on the appearance.	JIS C 5201-1 4.18 Soldering condition : $260\pm 5^{\circ}\text{C}$ Duration of immersion : $10\pm 1\text{s}$.
Rapid change of temperature	$\pm (1.0\%+0.05\Omega)$	JIS C 5201-1 4.19 Test temp. : $-55^{\circ}\text{C}\sim +125^{\circ}\text{C}$ 5cyc
Damp heat, steady state	$\pm (3.0\%+0.1\Omega)$	JIS C 5201-1 4.24 40°C , 93%RH Test time : 1,000h~1,048h
Endurance at 70°C	$\pm (3.0\%+0.1\Omega)$	JIS C 5201-1 4.25.1 Rated voltage (current), 70°C 1.5h : ON – 0.5h : OFF Test time : 1,000h~1,048h
Endurance	$\pm (3.0\%+0.1\Omega)$	JIS C 5201-1 4.25.3 125°C Test time : 1,000h~1,048h
Resistance to solvent	$\pm (1.0\%+0.05\Omega)$	JIS C 5201-1 4.29 $23\pm 5^{\circ}\text{C}$, Immersion cleaning, $5\pm 0.5\text{min}$. Solvent : 2-propanol
Bend strength of the end face plating	$\pm (1.0\%+0.05\Omega)$ Without mechanical damage such as breaks.	JIS C 5201-1 4.33

●External dimensions (Units : mm)

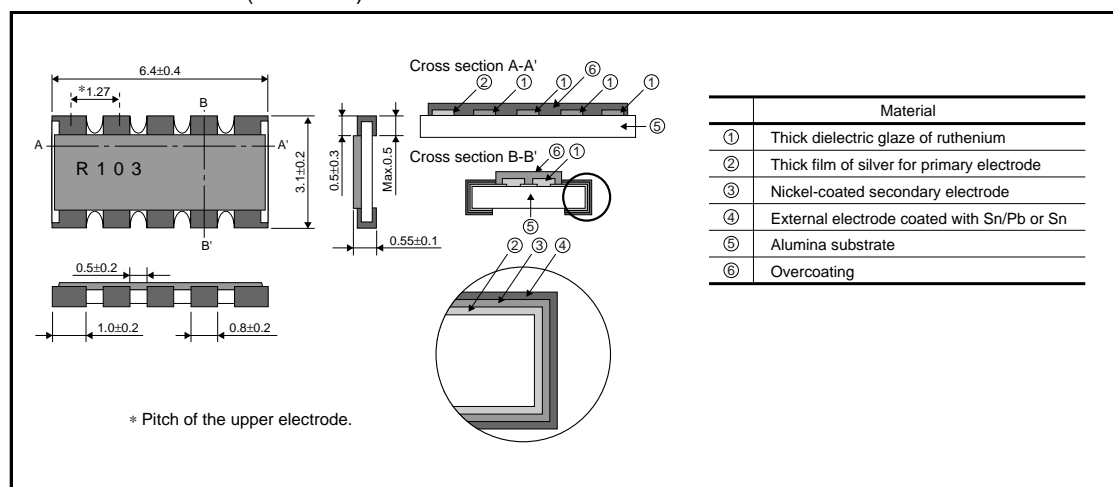

Resistors

●Equivalent circuit

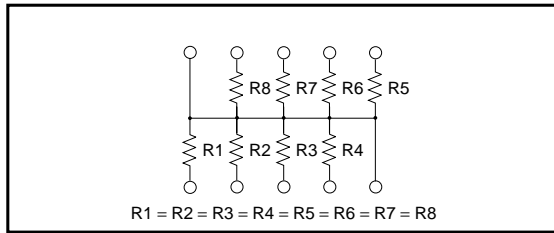

●Packaging

Reel	Taping																												
<p style="text-align: center;">EIAJ ET-7200A compliant</p> <p style="text-align: center;">(Units: mm)</p> <table border="1" style="margin-left: auto; margin-right: auto;"> <tr> <th>A</th> <th>B</th> <th>C</th> <th>D</th> </tr> <tr> <td>$\phi 180 \begin{smallmatrix} 0 \\ -3 \end{smallmatrix}$</td> <td>$\phi 60 \begin{smallmatrix} +1 \\ 0 \end{smallmatrix}$</td> <td>13±0.3</td> <td>$\phi 13 \pm 0.2$</td> </tr> </table>	A	B	C	D	$\phi 180 \begin{smallmatrix} 0 \\ -3 \end{smallmatrix}$	$\phi 60 \begin{smallmatrix} +1 \\ 0 \end{smallmatrix}$	13±0.3	$\phi 13 \pm 0.2$	<p style="text-align: right;">(Units: mm)</p> <table border="1" style="margin-left: auto; margin-right: auto;"> <tr> <th>W</th> <th>F</th> <th>E</th> <th>A₀</th> <th>B₀</th> </tr> <tr> <td>12.0±0.3</td> <td>5.5±0.05</td> <td>1.75±0.1</td> <td>3.4±0.1</td> <td>6.6±0.1</td> </tr> <tr> <th>D₀</th> <th>P₀</th> <th>P₁</th> <th>P₂</th> <th>K</th> </tr> <tr> <td>$\phi 1.5 \begin{smallmatrix} +0.1 \\ 0 \end{smallmatrix}$</td> <td>4.0±0.1</td> <td>4.0±0.1</td> <td>2.0±0.05</td> <td>1.0±0.15</td> </tr> </table>	W	F	E	A ₀	B ₀	12.0±0.3	5.5±0.05	1.75±0.1	3.4±0.1	6.6±0.1	D ₀	P ₀	P ₁	P ₂	K	$\phi 1.5 \begin{smallmatrix} +0.1 \\ 0 \end{smallmatrix}$	4.0±0.1	4.0±0.1	2.0±0.05	1.0±0.15
A	B	C	D																										
$\phi 180 \begin{smallmatrix} 0 \\ -3 \end{smallmatrix}$	$\phi 60 \begin{smallmatrix} +1 \\ 0 \end{smallmatrix}$	13±0.3	$\phi 13 \pm 0.2$																										
W	F	E	A ₀	B ₀																									
12.0±0.3	5.5±0.05	1.75±0.1	3.4±0.1	6.6±0.1																									
D ₀	P ₀	P ₁	P ₂	K																									
$\phi 1.5 \begin{smallmatrix} +0.1 \\ 0 \end{smallmatrix}$	4.0±0.1	4.0±0.1	2.0±0.05	1.0±0.15																									

●Product designation

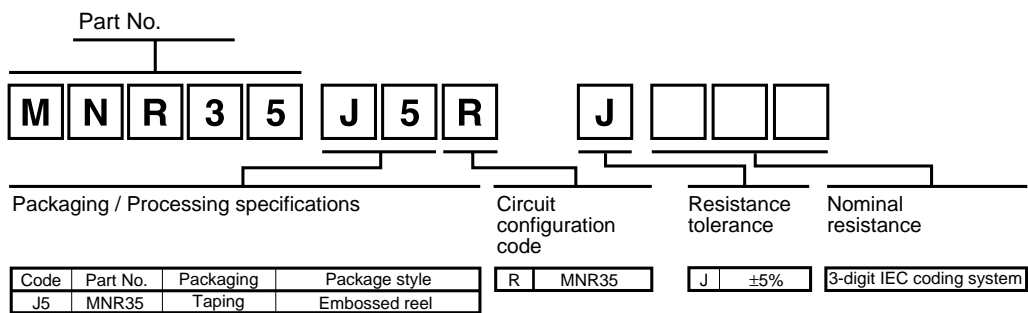

Resistors

●Electrical characteristics

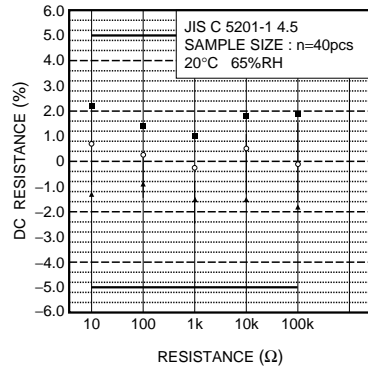

Fig.2 Resistance

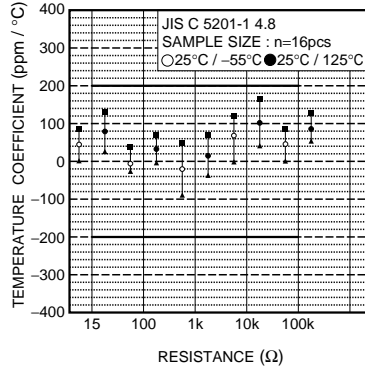

Fig.3 Variation resistance with temperature

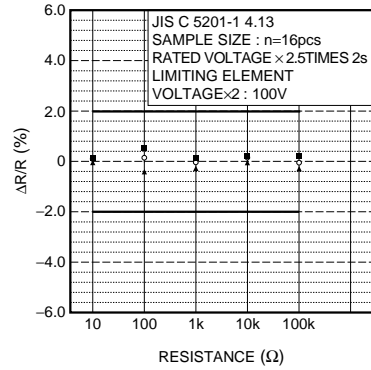

Fig.4 Overload

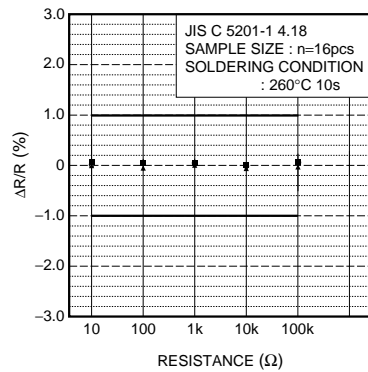

Fig.5 Resistance to soldering heat

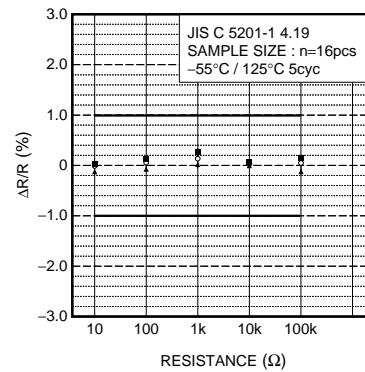

Fig.6 Rapid change of temperature

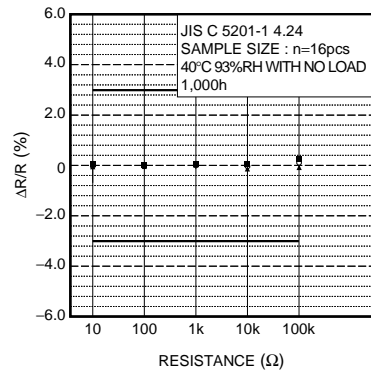

Fig.7 Damp heat, steady state

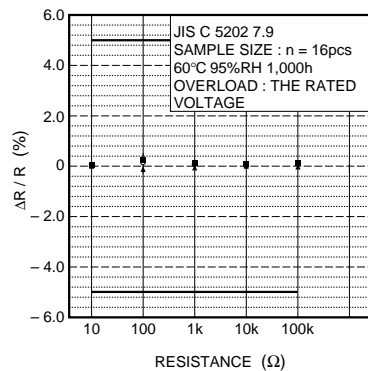

Fig.8 Endurance (under load in damp environment)

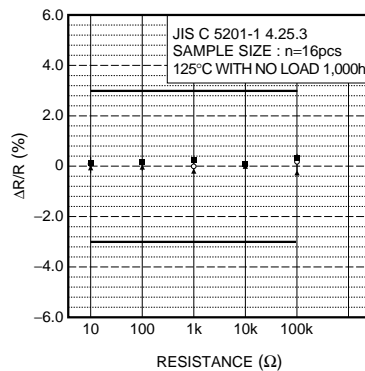

Fig.9 Endurance

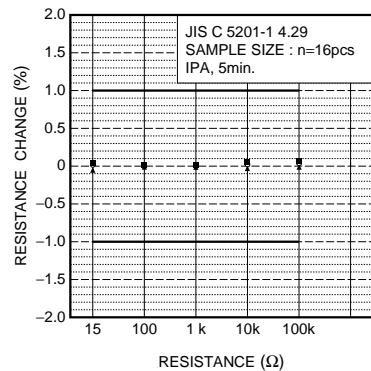

Fig.10 Resistance to solvents