

REV	MARK	DESCRIPTION	DRAFTED. BY	DATE

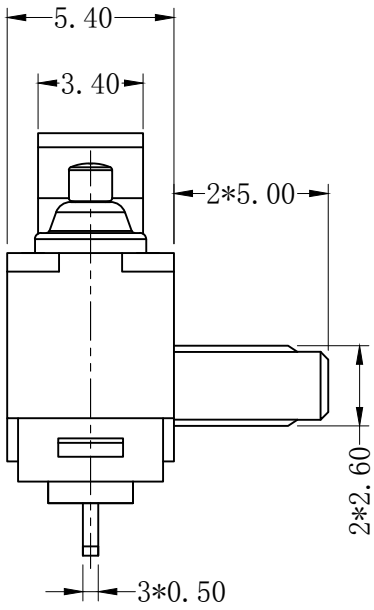

Circuit Diagram

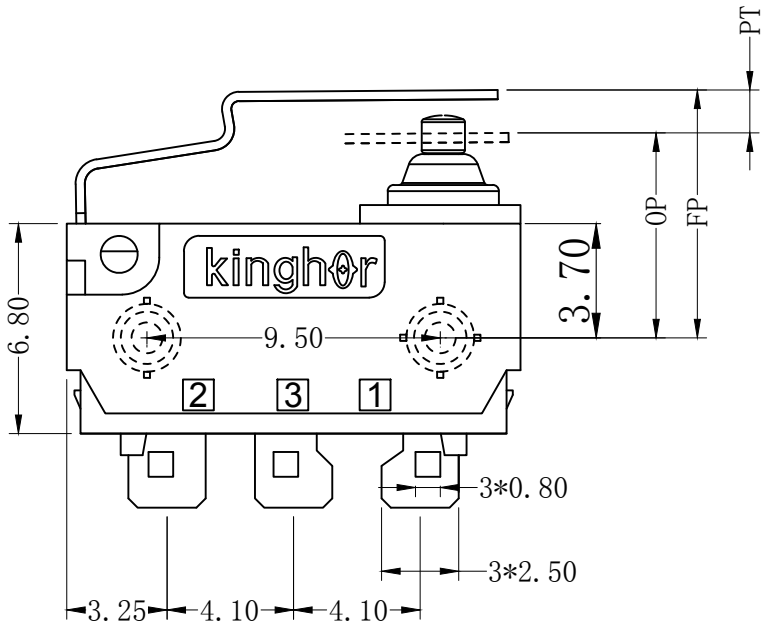
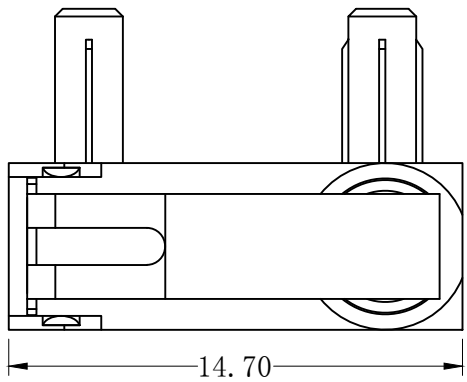
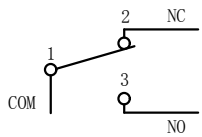

CHARACTERISTICS	
OPERATING FORCE (OF):	300gf Max.
RELEASE FORCE (RF):	40gf Min.
OPERATING POSITION:	6.8 ± 0.5 mm.
PRE TRAVEL:	2.7mm Max.
DIFFERENTIAL TRAVEL:	0.3mm Max.
FREE POSITION:	9.5mm Max.

ELECTRICAL DATA	
RATING	OPERATING LIFE
3A 12VDC	100,000 CYCLES
0.1A 48VDC 125/250VAC	100,000 CYCLES

MECHANICAL LIFE	500,000 CYCLES
GAP TYPE	MICRO
OPERATING TEMP	-40°C ~ +85°C
WATERPROOF	IP67

OUTLINE DRAWING			
TITLE	H3 SERIES MICRO SWITCH		
MODEL	H3-A3		
PART NO.	H3-A3-1D11S		
DRAFTED BY	Bing Wang	DATE	2020-9-7
CHECKED BY	Hua Bai	DATE	2020-9-7
APPROVED BY	Hong Chen	DATE	2020-9-7

TOLERANCE UNLESS OTHERWISE SPECIFIED						
≤3	1~3	3~10	10~30	30~100	100~200	ANGLE
±0.2	±0.3	±0.4	±0.6	±1.0	±1.5	±3.0°
					SCALE	
					UNIT	mm
					VERSION	REV
						A1

KINGHOR
SWITCHES AND CONTROL EXPERT