

2~5PIN无卡点视图

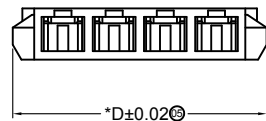

*D±0.02

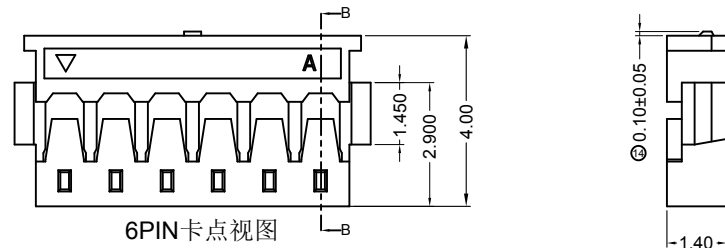

6PIN卡点视图

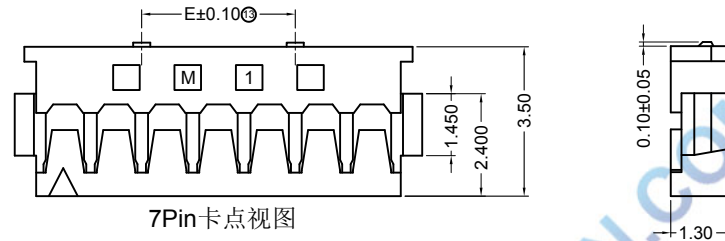

7PIN卡点视图

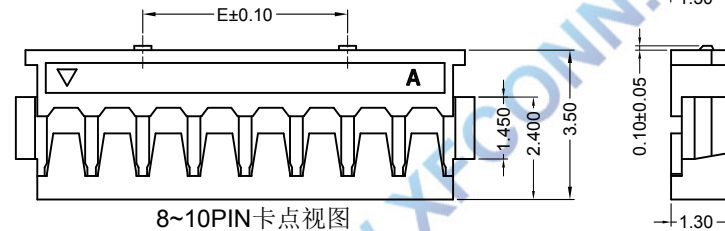

8~10PIN卡点视图

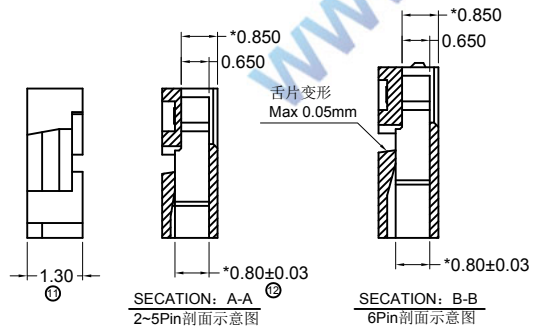
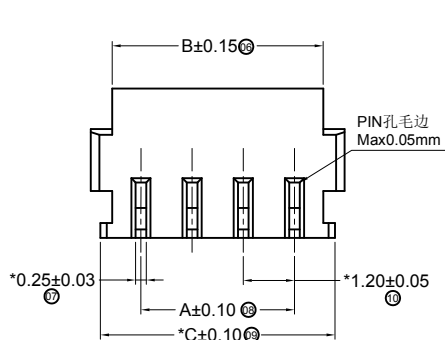

SECTION: A-A
2-5Pin剖面示意图

SECTION: B-B
6Pin剖面示意图

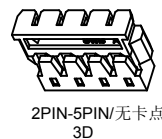

2PIN-5PIN/无卡点
3D

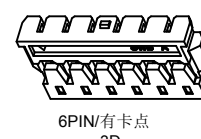

6PIN/有卡点
3D



7-10PIN/有卡点
3D

SPECIFICATIONS

- 1.Voltage rating: 50V AC, DC
- 2.Current rating: 2A, AC, DC
- 3.Withstanding Voltage: 500V AC/minute
- 4.Insulation resistance:100M min
- 5.Temperature range: -25 ° C-+85 ° C
- 6.Contact resistance: 20m max

HOUSING

Housing Material:Nylon66 UL94V-0(2)
Accepts :T1201 terminal
Mates with: M1201 series header
Poles : 02-10P
Part No.: P1201-xx-BK

Pin位数

Poles	Dimensions(mm)				
	A	B	C	D	E
2	1.20	2.60	3.10	3.60	
3	2.40	3.80	4.30	4.80	
4	3.60	5.00	5.50	6.00	
5	4.80	6.20	6.70	7.20	
6	6.00	7.40	7.90	8.40	
7	7.20	8.60	9.10	9.60	3.60
8	8.40	9.80	10.30	10.80	4.80
9	9.60	11.00	11.50	12.00	3.60
10	10.80	12.20	12.70	13.20	4.80



				TOLERANCE UNLESS OTHERWISE		DRAWN	CK tan	XFCN兴飞连接器有限公司 CONNECTORS XFCN CONNECTORS CO., LTD.		SHEET	1/1
				X.	±0.30	X°	±5°			CHKD	DATE
				.X	±0.20	.X°	±2°	APPD	PRODUCT NAME	1.20mm Crimp Style Connectors	
				.XX	±0.08	.XX°	±1°	VIEW	PART. NO.	P1201-xx-BK	
				.XXX	±0.03	.XXX°	±0.5°				
AO VER	MODIFICATION		DRAW	DATE							