

Description

RSFD2503C is a high performance duplexer designed for applications in LTE Band7 (2500~2570 MHz UL, 2620~2690 MHz DL).

RSFD2503C is designed with ROFS's MEMS BAW technology, which provides high Q filters and first-class reliability. Low insertion loss and return loss of Tx port reduce the current from power amplifier. High out-of-band attenuation in the Wi-Fi band coexist with Wi-Fi signal under working condition. High isolation of Rx port improve sensitivity in the receive band .

RSFD2503C uses chip scale packaging (CSP) technology to assembly the filters into a molded chip-on-board module with the footprint of 1.8mm x 1.4mm and height of 0.61mm.

Features

- Miniature Size
1.8 mm x 1.4 mm x 0.61 mm
- Insertion Loss:
 - Tx 1.8 dB Typ.
 - Rx 1.6 dB Typ.
- Tx-RX Isolation:
 - Tx Pass Band 53 dB Typ.
 - Rx Pass Band 61 dB Typ.
- Tx Input Power
 - 30 dBm
- ESD protection ability: Class1C
- Moisture Sensitivity: MSL3
- Storage Temperature: -40 to +85 °C

Environmental

- Full implement with RoHS compliant
- Lead Free (Pb free)

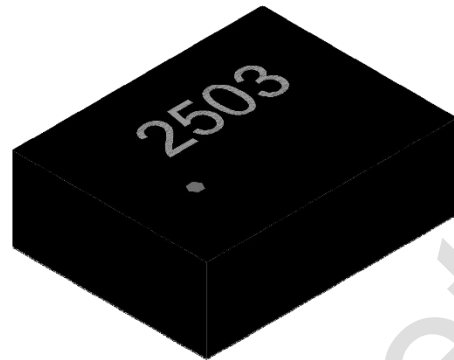

8 Pin 1.8 x 1.4 x 0.61mm Package

Functional Block Diagram (Top Thru View)

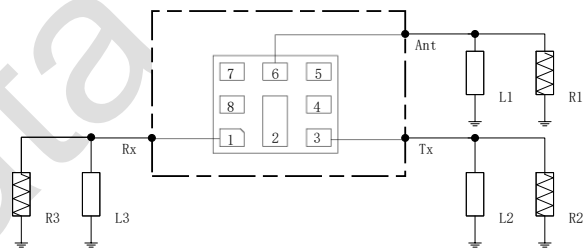

Reference Des.	Value	Description
R1	50ohm	
R2	50ohm	
R3	50ohm	
L1	2.7nH	Ideal Inductor
L2	4.7nH	Ideal Inductor
L3	3.9nH	Ideal Inductor

Pin Connection

No.	Function
1	Rx
3	Tx
6	Ant
2,4,5,7,8	Ground

Electrical Specification

Transmit Port to Antenna Port				
Parameter (Operation Temperature: -20~85°C)	Min	Typ*	Max	Unit
Insertion Loss (2500~2570MHz)	/	1.8	2.7	dB
Ripple (2500~2570MHz)	/	0.8	1.6	dB
VSWR (2500~2570MHz,ANT Port)	/	1.3	1.9	/
VSWR (2500~2570MHz,TX Port)	/	1.2	1.9	/
Absolute Attenuation (500~8000MHz)				
(500~1560MHz)	33	40	/	dB
(1565 ~1606MHz)	32	39	/	dB
(1805~1880MHz)	30	36	/	dB
(2110~2170MHz)	29	35	/	dB
(2300~2400MHz)	23	29	/	dB
(2400~2472MHz)	36	41	/	dB
(2472~2481MHz)	22	33	/	dB
(2620~2690MHz)	52	59	/	dB
(3400~3600MHz)	44	51	/	dB
(4500~5500MHz, <i>2fo</i>)	32	38	/	dB
(5600~7200MHz)	26	33	/	dB
(7200~8000MHz, <i>3fo</i>)	19	25	/	dB
Antenna Port to Receive Port				
Parameter (Operation Temperature: -20~85°C)	Min	Typ*	Max	Unit
Insertion Loss (2620~2690MHz)	/	1.6	2.5	dB
Ripple (2620~2690MHz)	/	0.6	1.4	dB
VSWR (2620~2690MHz,ANT Port)	/	1.6	2.0	/
VSWR (2620~2690MHz,RX Port)	/	1.6	2.0	/
Absolute Attenuation (500~8000MHz)				
(500~1680MHz)	37	44	/	dB
(1710~1785MHz)	36	42	/	dB
(1920~1980MHz)	33	39	/	dB
(2400~2500MHz)	39	45	/	dB
(2500~2570MHz)	48	53	/	dB
(2750~4900MHz)	37	44	/	dB
(4900~5600MHz, <i>2fo</i>)	43	49	/	dB
(5600~7400MHz)	40	47	/	dB
(7400~8000MHz, <i>3fo</i>)	28	34	/	dB

Transmit Port to Receive Port

Parameter(Operation Temperature: -20~85°C)	Min	Typ*	Max	Unit
Isolation				
2500~2570MHz	50	53	/	dB
2620~2690MHz	56	61	/	dB

*Data is the integrated value of the linear s-parameter over indicated band

* Typical value at 25±3 °C

Typical Performance at Tc=25°C

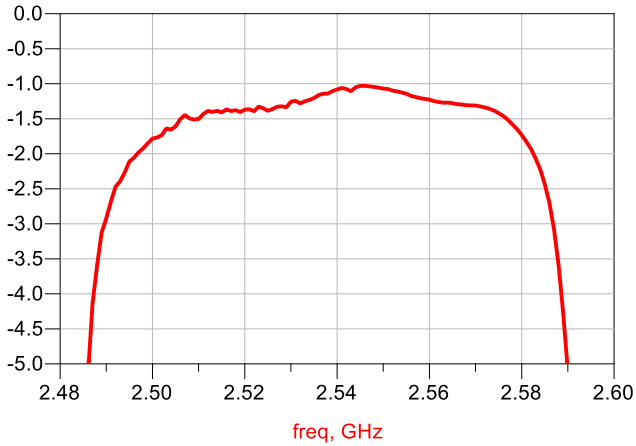

Figure1. TX-ANT Passband

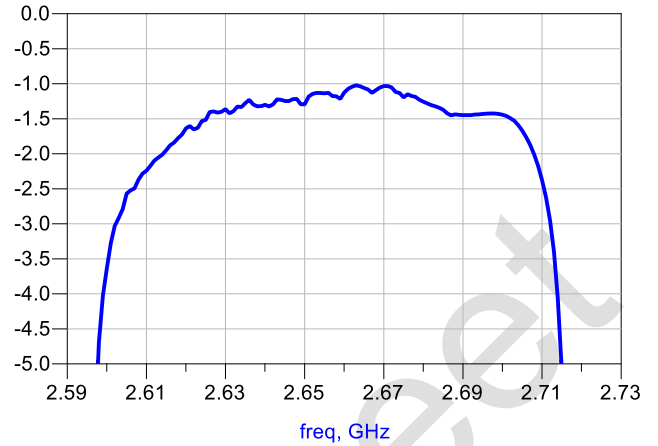

Figure2. ANT-RX Passband

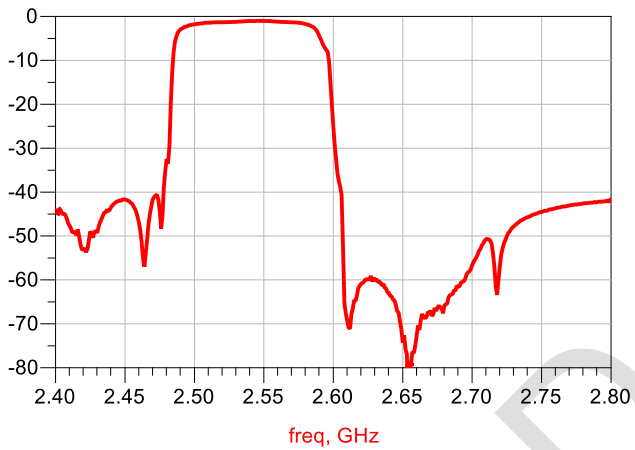

Figure3. TX-ANT

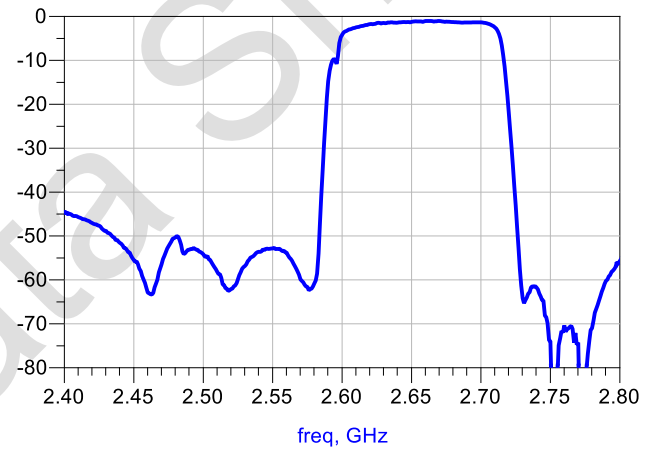

Figure4. ANT-RX

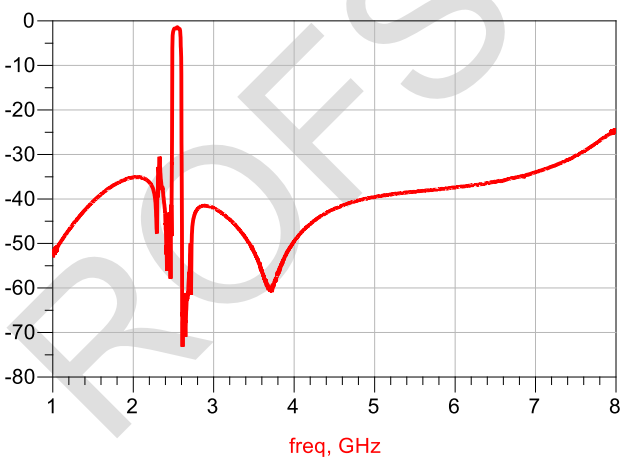

Figure5. TX-ANT Wideband

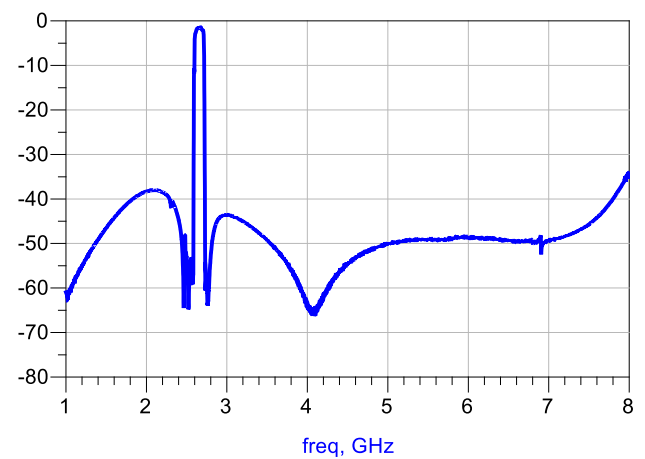

Figure6. ANT-RX Wideband

Typical Performance at Tc=25°C

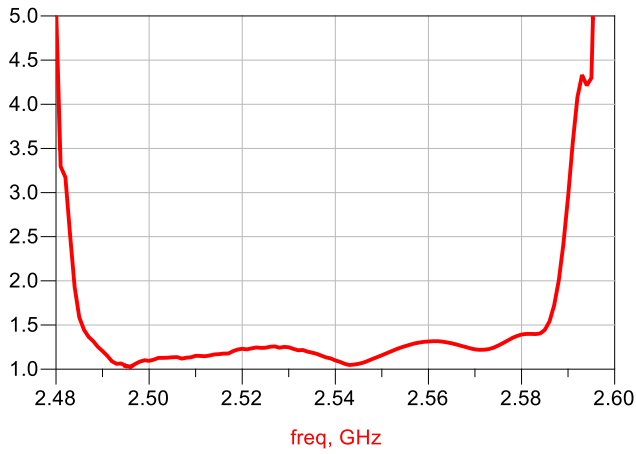

Figure7. TX Port VSWR

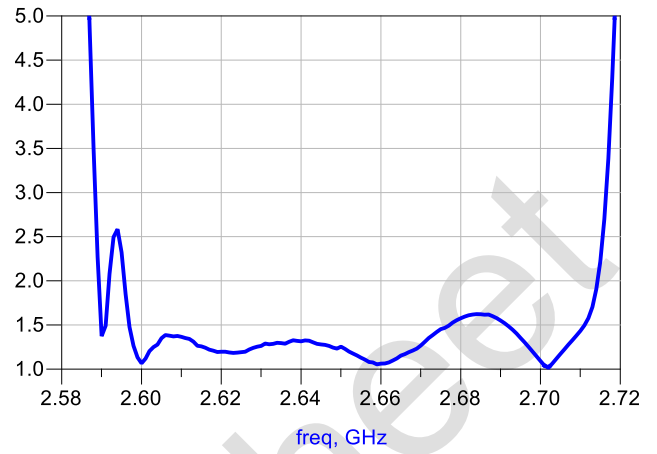

Figure8. RX Port VSWR

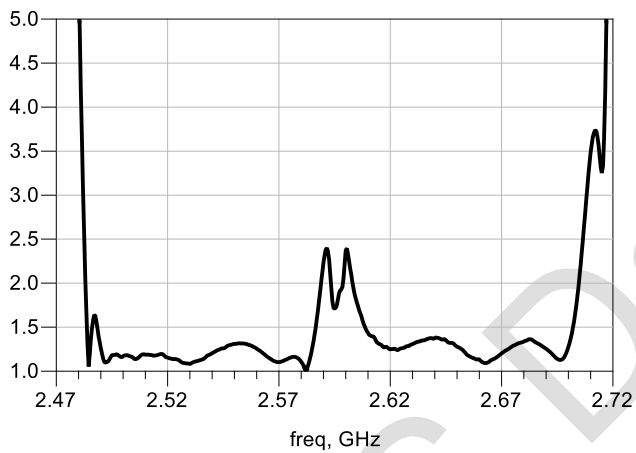

Figure9. Ant Port VSWR

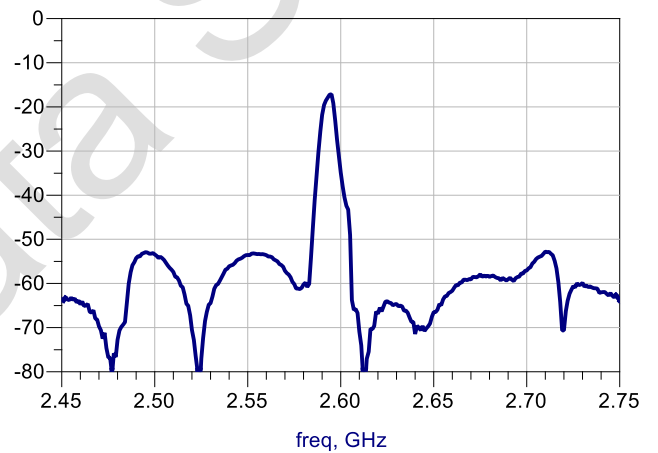
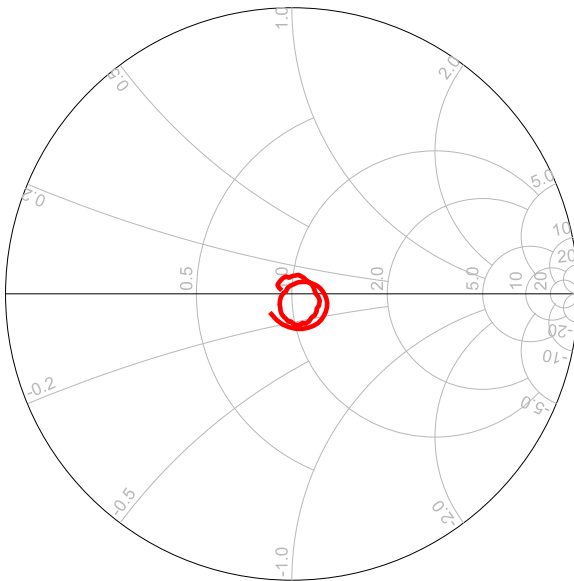

Figure10. TX - RX Isolation

Typical Performance at Tc=25°C



freq (2.500GHz to 2.570GHz)

Figure11. TX Smith Chart

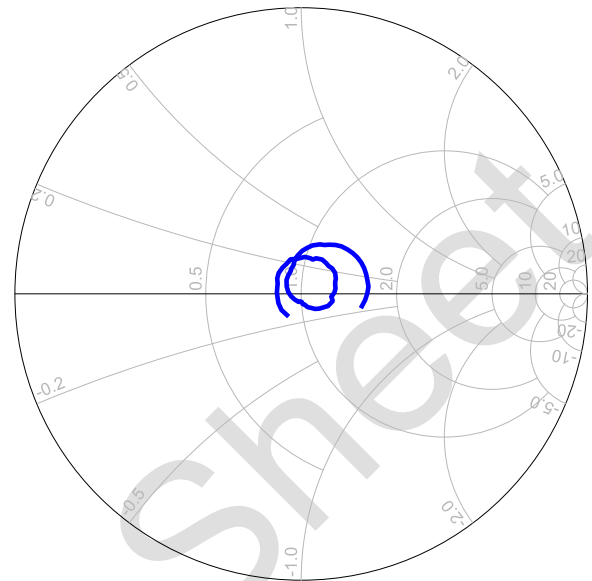

freq (2.620GHz to 2.690GHz)

Figure12. RX Smith Chart

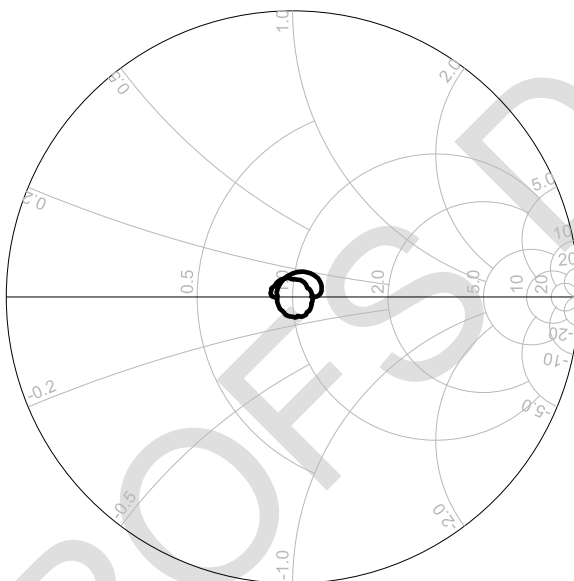

freq (2.500GHz to 2.570GHz)

Figure13.Ant (Tx Pass Band) Smith Chart

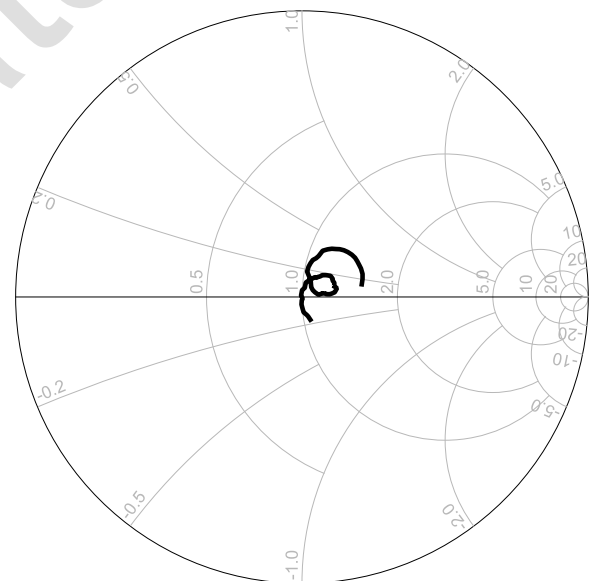

freq (2.620GHz to 2.690GHz)

Figure14. Ant (Rx Pass Band) Smith Chart

Package Outline

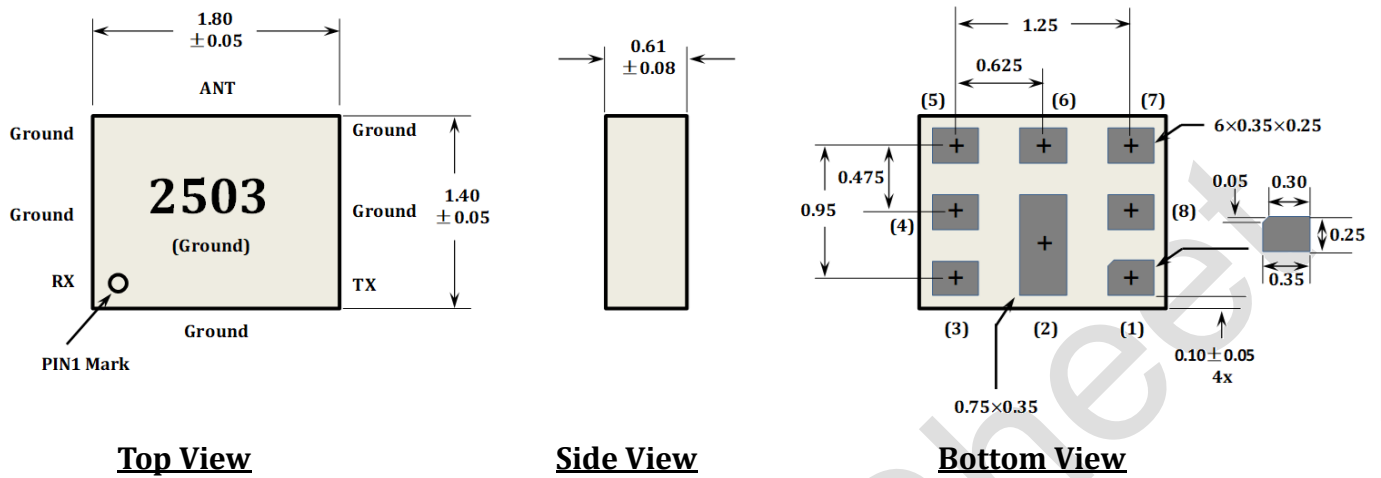

Note:

1. Dimension: mm
2. Dimensions nominal unless otherwise noted
3. Contact area are gold plated
4. Pad(1)(2) is single size, others are same size
5. 2503 is product code

No.	Function
1	Rx
3	Tx
6	Ant
2,4,5,7,8	Ground

Order Information

P/N	Qty./Reel	Container
RSFD2503C	4000	7 inch Reel

Packing

1. Tape Dimension

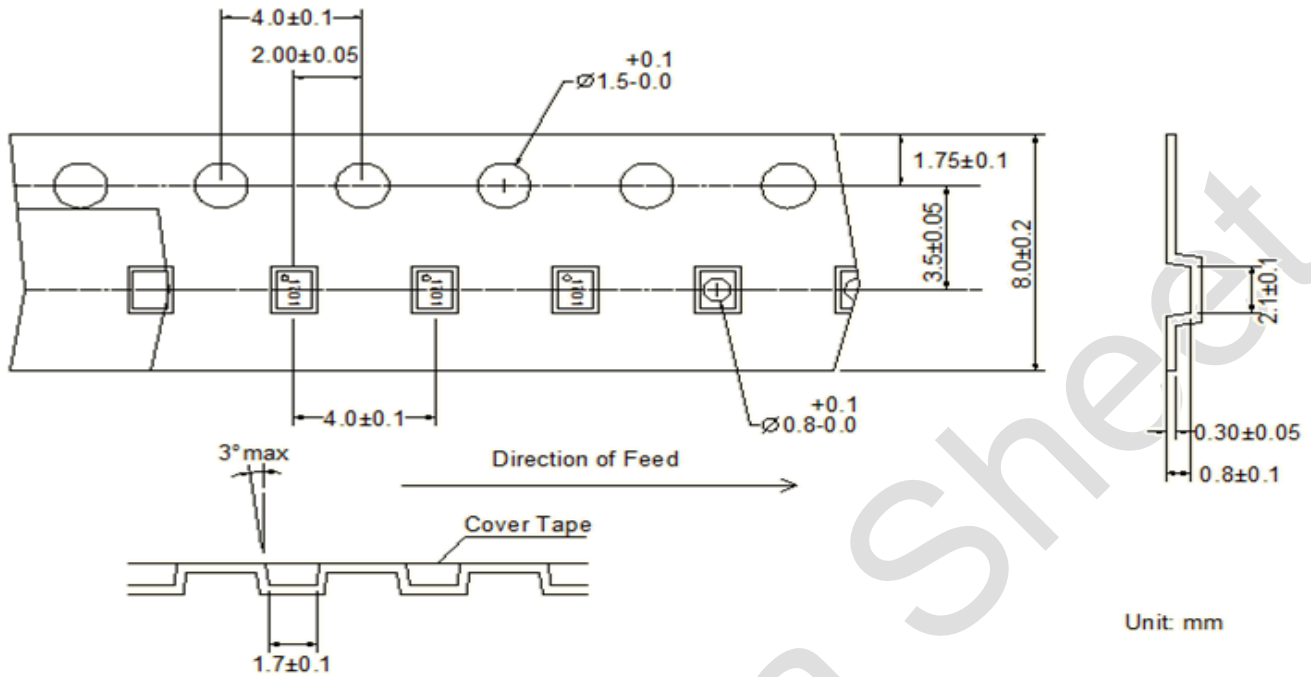

2. Reel Dimension

4000Pcs/Reel

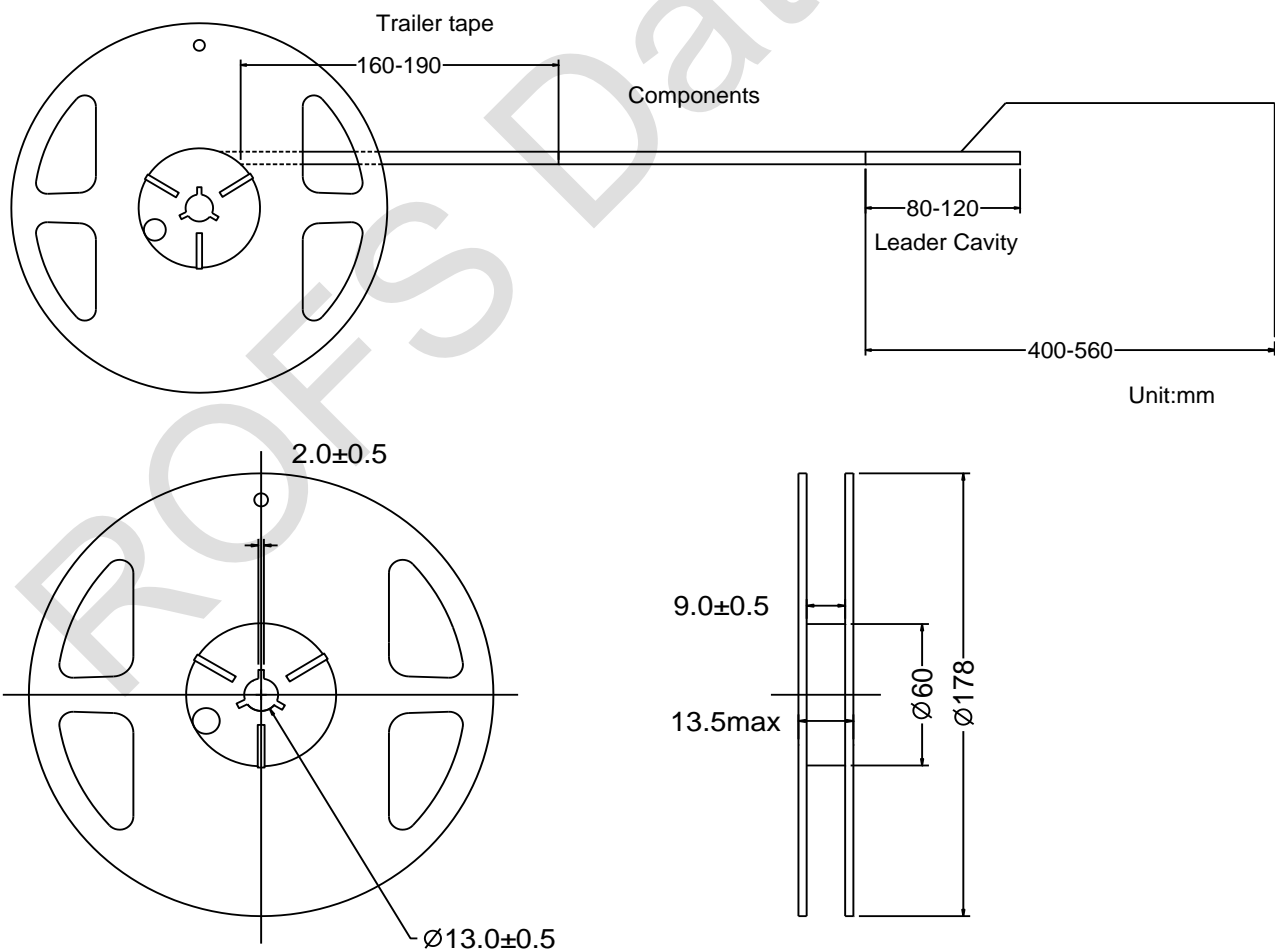

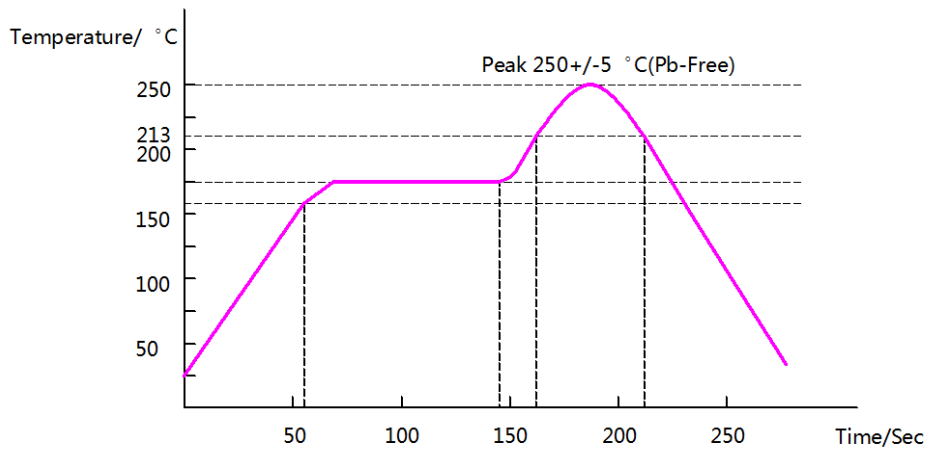
Recommended Reflow Profile

For more information, please contact: sales@rofsmicro.com

Notes:

The specification may be changed or the product had been discontinued, please check with our sales or product engineer before order.

RSFD2503C Datasheet Modify History

Revision	Description	Date
Rev 0	Preliminary revision	7/23/2019
RevA	增加 Min Max	3/25/2020