

Feature

- 100V,60A
 $R_{DS(ON)} < 9.5m\Omega @ V_{GS}=10V$ (TYP:7.5m Ω)
 $R_{DS(ON)} < 13m\Omega @ V_{GS}=4.5V$ (TYP:10.5m Ω)
- Split Gate Trench Technology
- Lead free product is acquired
- Excellent $R_{DS(ON)}$ and Low Gate Charge

Application

- PWM applications
- Load Switch
- Power management

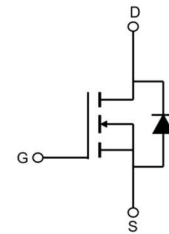

Schematic Diagram

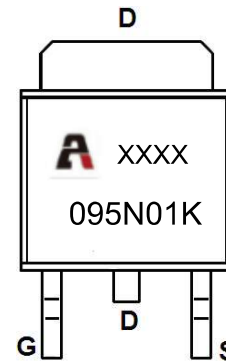

Marking and pin assignment

Package Marking and Ordering Information

Device Marking	Device	Device Package	Reel Size	Tape width	Quantity (PCS)
G095N01K	APG095N01K	TO-252	13 inch	-	2500

ABSOLUTE MAXIMUM RATINGS ($T_a=25^\circ\text{C}$ unless otherwise noted)

Parameter	Symbol	Value	Unit
Drain-Source Voltage	V_{DS}	100	V
Gate-Source Voltage	V_{GS}	± 20	V
Continuous Drain Current ($T_a=25^\circ\text{C}$)	I_D	60	A
Continuous Drain Current ($T_a=100^\circ\text{C}$)	I_D	38	A
Pulsed Drain Current ⁽¹⁾	I_{DM}	240	A
Singel Pulsed Avalanche Energy ⁽²⁾	E_{AS}	90	mJ
Power Dissipation	P_D	63	W
Thermal Resistance from Junction to Case	$R_{\theta JC}$	2.0	$^\circ\text{C}/\text{W}$
Junction Temperature	T_J	150	$^\circ\text{C}$
Storage Temperature	T_{STG}	-55~ +150	$^\circ\text{C}$

MOSFET ELECTRICAL CHARACTERISTICS(T_a=25°C unless otherwise noted)

Parameter	Symbol	Test Condition	Min	Type	Max	Unit
Static Characteristics						
Drain-source breakdown voltage	V _{(BR)DSS}	V _{GS} = 0V, I _D =250μA	100	-	-	V
Zero gate voltage drain current	I _{DSS}	V _{DS} =80V, V _{GS} = 0V	-	-	1	μA
Gate-body leakage current	I _{GSS}	V _{GS} = ±20V, V _{DS} = 0V	-	-	±100	nA
Gate threshold voltage ⁽³⁾	V _{GS(th)}	V _{DS} =V _{GS} , I _D =250μA	1.2	2.0	2.5	V
Drain-source on-resistance ⁽³⁾	R _{DS(on)}	V _{GS} =10V, I _D =20A	-	7.5	9.5	mΩ
		V _{GS} =4.5V, I _D =10A	-	10.5	13	
Forward Threshold Voltage	g _{fs}	V _{DS} =5V, I _D =20A	-	13.5	-	S
Gate Resistance	R _g	V _{DS} =V _{GS} =0V, f =1MHz	-	1.94	-	Ω
Dynamic characteristics						
Input Capacitance	C _{iss}	V _{DS} =50V, V _{GS} =0V, f =1MHz	-	2122	-	pF
Output Capacitance	C _{oss}		-	618	-	
Reverse Transfer Capacitance	C _{rss}		-	25	-	
Switching characteristics						
Turn-on delay time	t _{d(on)}	V _{DD} =50V, I _D =20A, V _{GS} =10V, R _G =3Ω	-	17	-	ns
Turn-on rise time	t _r		-	4	-	
Turn-off delay time	t _{d(off)}		-	32	-	
Turn-off fall time	t _f		-	8	-	
Total Gate Charge	Q _g	V _{DS} =50V, I _D =20A, V _{GS} =10V	-	41.8	-	nC
Gate-Source Charge	Q _{gs}		-	9	-	
Gate-Drain Charge	Q _{gd}		-	10	-	
Reverse Recovery Charge	Q _{rr}	I _F =20A, di/dt=100A/us		71.5		nC
Reverse Recovery Time	T _{rr}	I _F =20A, di/dt=100A/us		50.5		ns
Source-Drain Diode characteristics						
Diode Forward voltage ⁽³⁾	V _{DS}	V _{GS} =0V, I _S =20A	-	-	1.2	V
Diode Forward current ⁽⁴⁾	I _S		-	-	60	A

Notes:

1. Repetitive Rating: pulse width limited by maximum junction temperature
2. EAS Condition: T_J=25°C, V_{DD}=50V, R_G=25 Ω, L=0.5mH
3. Pulse Test: pulse width ≤300μs, duty cycle ≤2%
4. Surface Mounted on FR4 Board, t ≤10 sec

Typical Performance Characteristics

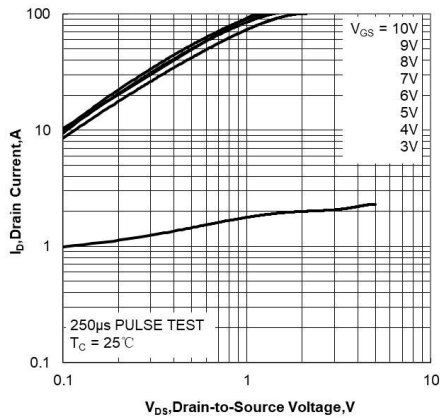

Figure 1. Output Characteristics

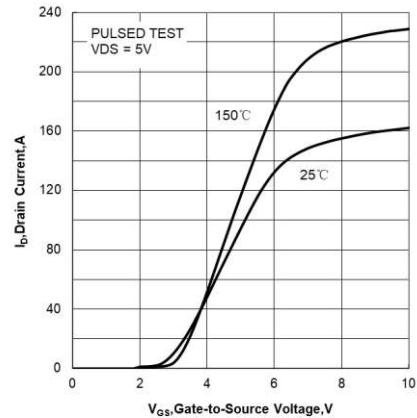

Figure 2. Transfer Characteristics

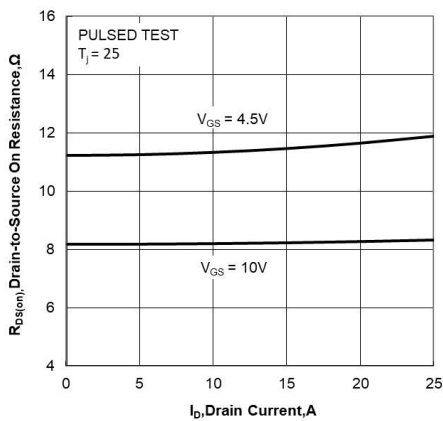

Figure 3. Drain-to-Source On Resistance vs Drain Current

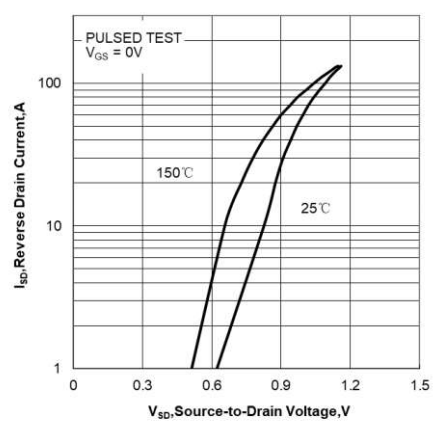

Figure 4. Body Diode Forward Voltage vs Source Current and Temperature

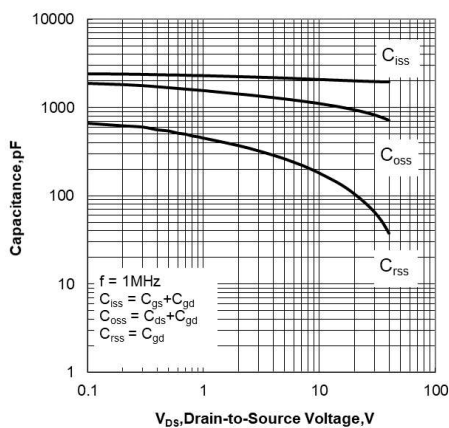

Figure 5. Capacitance Characteristics

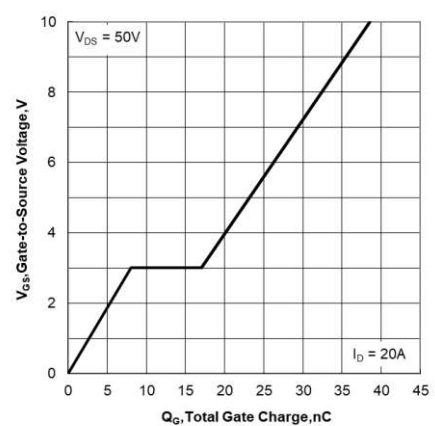

Figure 6. Gate Charge Characteristics

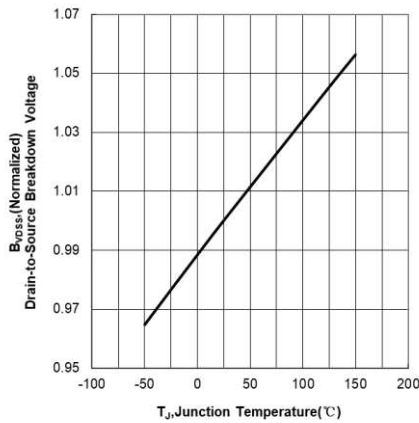

Figure 7. Normalized Breakdown Voltage vs Junction Temperature

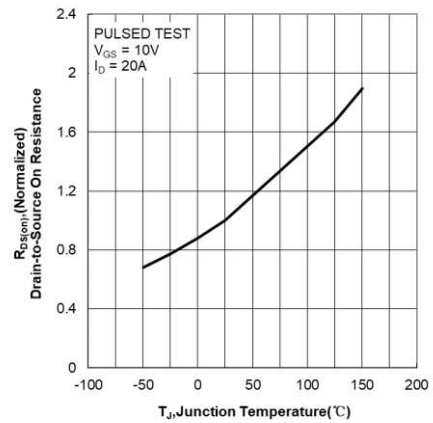

Figure 8. Normalized On Resistance vs Junction Temperature

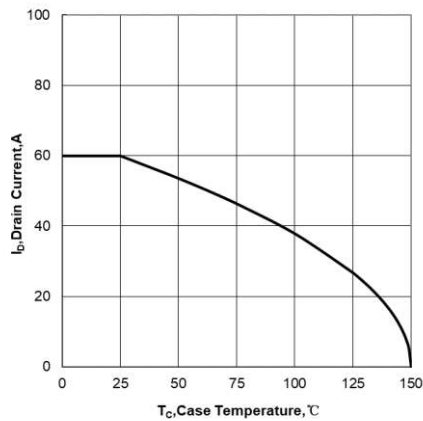

Figure 9. Maximum Continuous Drain Current vs Case Temperature

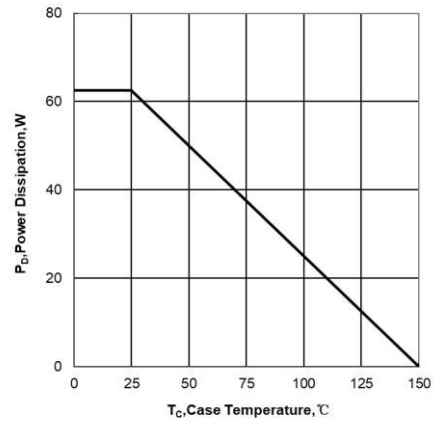

Figure 10. Maximum Power Dissipation vs Case Temperature

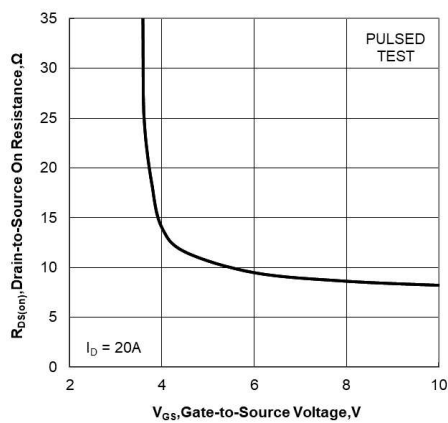

Figure 11. Drain-to-Source On Resistance vs Gate Voltage and Drain Current

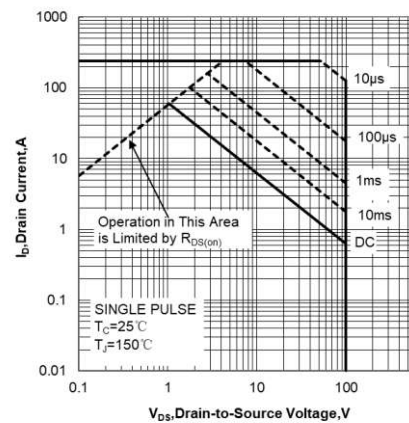

Figure 12. Maximum Safe Operating Area

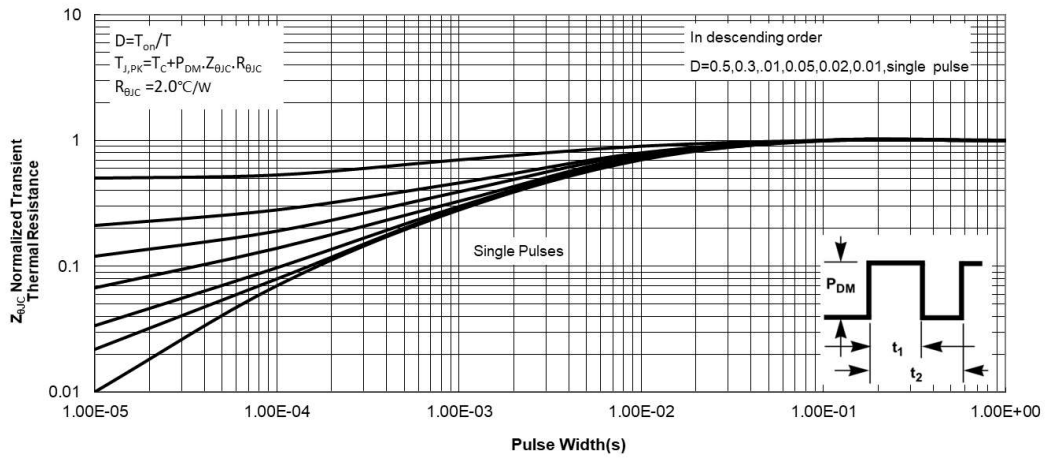
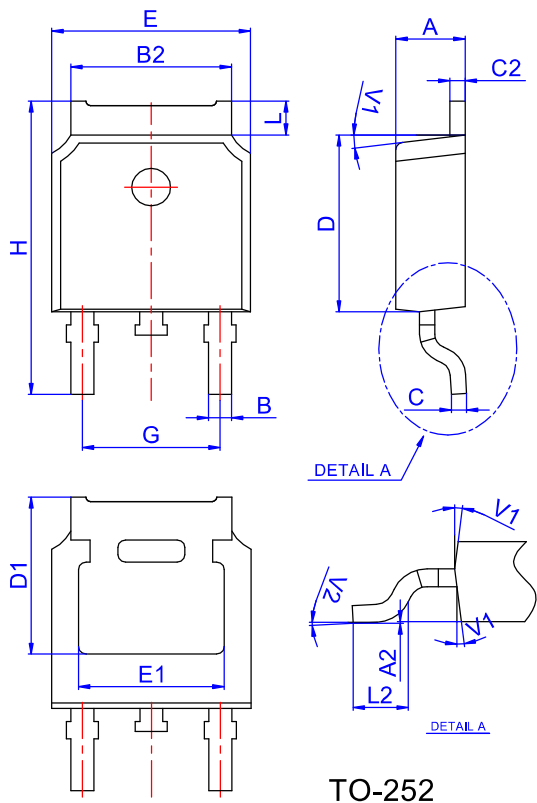

Figure 13. Maximum Effective Transient Thermal Impedance, Junction-to-Case

TO-252 Package Information



Ref.	Dimensions					
	Millimeters			Inches		
	Min.	Typ.	Max.	Min.	Typ.	Max.
A	2.10		2.50	0.083		0.098
A2	0		0.10	0		0.004
B	0.66		0.86	0.026		0.034
B2	5.18		5.48	0.202		0.216
C	0.40		0.60	0.016		0.024
C2	0.44		0.58	0.017		0.023
D	5.90		6.30	0.232		0.248
D1	5.30REF			0.209REF		
E	6.40		6.80	0.252		0.268
E1	4.63			0.182		
G	4.47		4.67	0.176		0.184
H	9.50		10.70	0.374		0.421
L	1.09		1.21	0.043		0.048
L2	1.35		1.65	0.053		0.065
V1		7°			7°	
V2	0°		6°	0°		6°

Reel Specification-TO-252

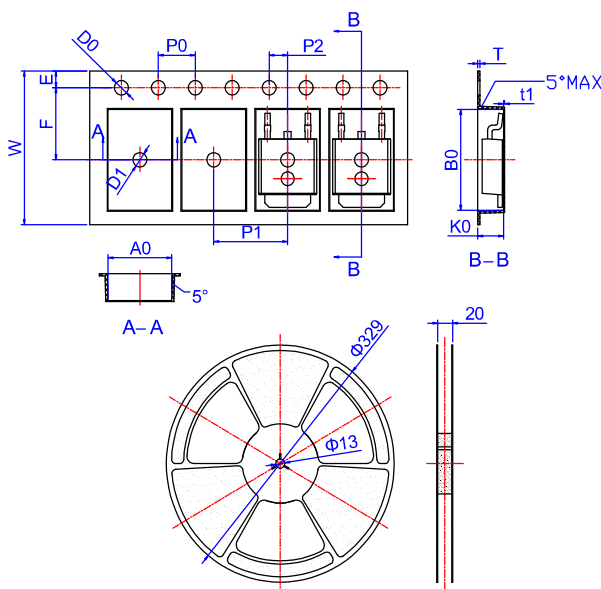

Ref.	Dimensions					
	Millimeters			Inches		
	Min.	Typ.	Max.	Min.	Typ.	Max.
W	15.90	16.00	16.10	0.626	0.630	0.634
E	1.65	1.75	1.85	0.065	0.069	0.073
F	7.40	7.50	7.60	0.291	0.295	0.299
D0	1.40	1.50	1.60	0.055	0.059	0.063
D1	1.40	1.50	1.60	0.055	0.059	0.063
P0	3.90	4.00	4.10	0.154	0.157	0.161
P1	7.90	8.00	8.10	0.311	0.315	0.319
P2	1.90	2.00	2.10	0.075	0.079	0.083
A0	6.85	6.90	7.00	0.270	0.271	0.276
B0	10.45	10.50	10.60	0.411	0.413	0.417
K0	2.68	2.78	2.88	0.105	0.109	0.113
T	0.24		0.27	0.009		0.011
t1	0.10			0.004		
10P0	39.80	40.00	40.20	1.567	1.575	1.583