



承認書

Specification For Approval

Customer: (客戶)

Description: (產品描述)

SMD1615灯珠红普绿双色

Part number: (產品型號)

TJ-S1615CY6TGLC2R7K-A5

Date: (日期)

Approved By: (客戶承認)

--

Prepared By: (我司承認)

Approval	Check	Design	Sales

核准

審核

製作

業務

Customer Service Hotline: **400-676-8616**

TEL: 0769-8662 5999 0769-8200 2226

E-MAIL : dg@togialed.com

FAX: 0769-8200 2227

WEB: www.togialed.com

Features

1.5mm × 1.6mm SMT LED, 0.6mm thickness

Low power consumption

Wide view angle

Package: 4000pcs/reel

RoHS Compliant

Applications

Ideal for back light and indicator

Various colors and lens types available

Package outlines

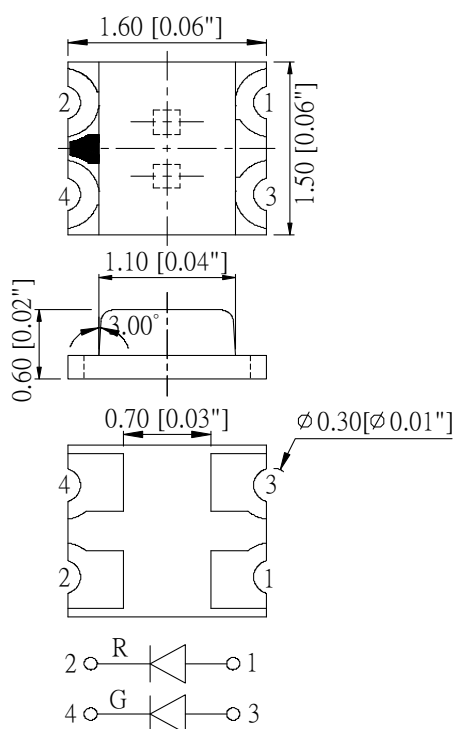

Recommend Pad Layout

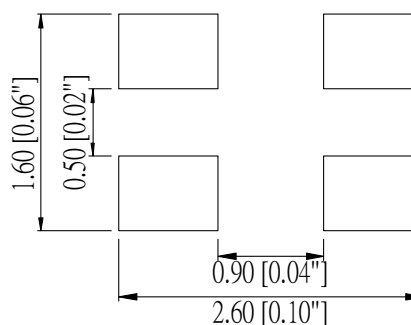

Part No.	Emitted color	Dice	Lens color
TJ-S1615CY6TGLC2R7K-A5	Red	AlGaInP	Water transparent
	Green	AlGaInP	

Notes:

- All dimensions are in millimeters (inches);
- Tolerances are $\pm 0.1\text{mm}$ (0.004inch) unless otherwise noted.

Absolute maximum ratings (TA=25°C)

Parameter	Symbol	Value		Unit
		R	G	
Power dissipation	Pd	72	72	mW
Forward current	If	30		mA
Reverse voltage	Vr	5		V
Operating temperature	Top	-40 ~+80		°C
Storage temperature	Tstg	-40 ~+85		°C
Peak pulsing current (1/8 duty f=1kHz)	Ifp	125		mA

Electro-optical characteristics (TA=25°C)

Parameter	Test Condition	Symbol	Value			Unit
			Min	Typ	Max	
Wavelength at peak emission	If=20mA	λ_p R	--	630	--	nm
		G	--	580	--	
Spectral half bandwidth	If=20mA	$\Delta \lambda$ R	--	18	--	nm
		G	--	16	--	
Dominant wavelength	If=20mA	λ_d R	620	--	630	nm
		G	565	--	575	
Forward voltage	If=20mA	Vf R	1.8	--	2.4	V
		G	1.8	--	2.4	
Luminous intensity	If=20mA	Iv R	60	--	200	mcd
		G	25	--	80	
Viewing angle at 50% Iv	If=10mA	$2\theta_{1/2}$	--	120	--	Deg
Reverse current	Vr=5V	Ir	--	--	10	μ A

Optical characteristic curves (Red)

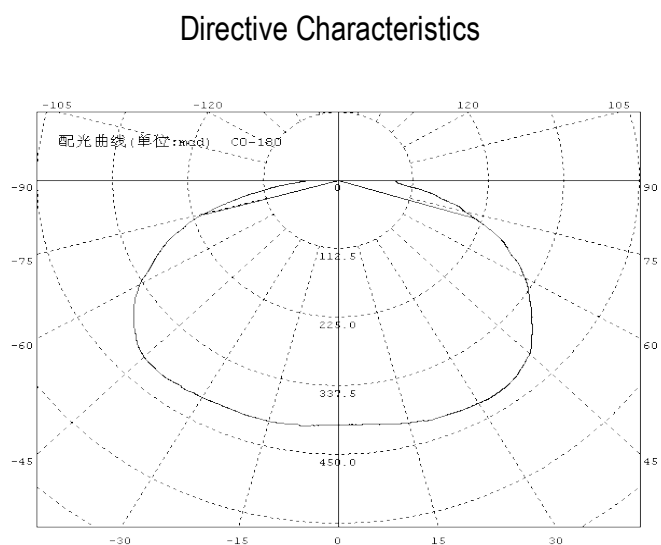
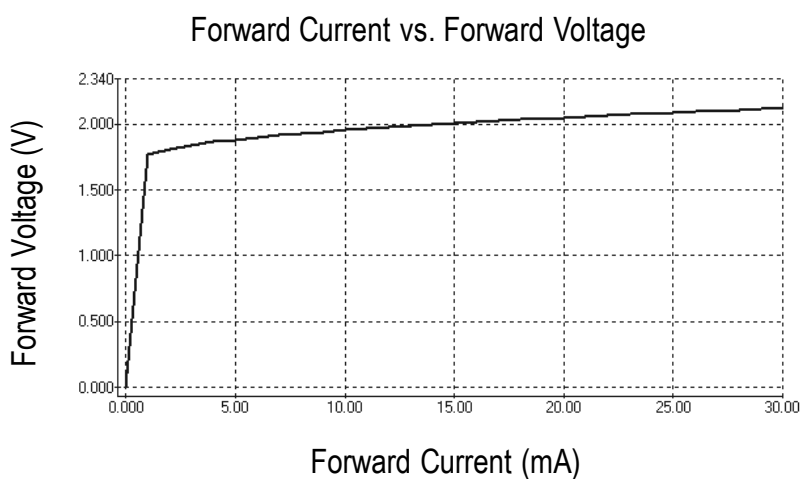
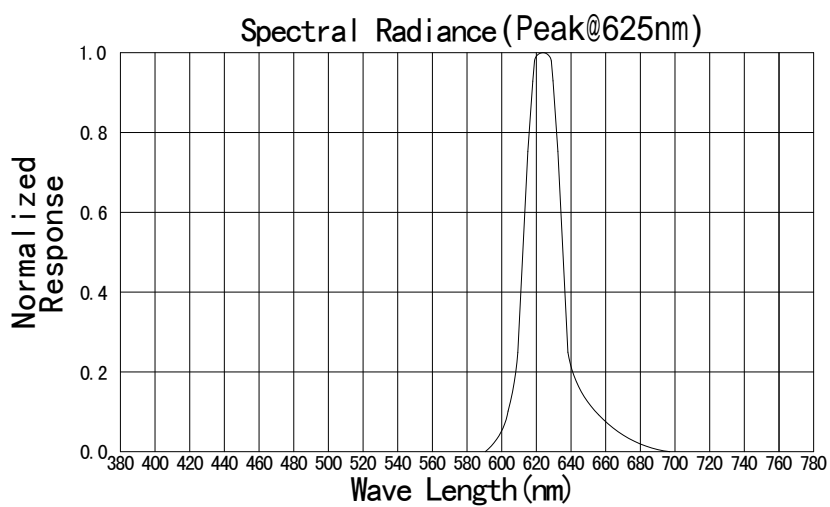

Optical characteristic curves (Green)

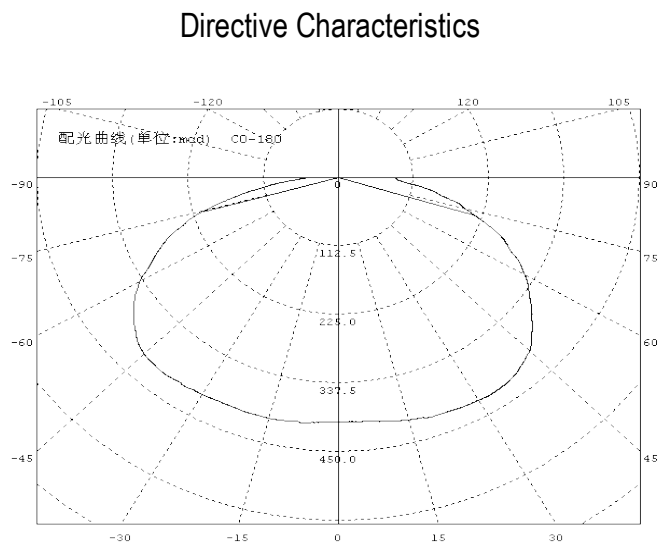
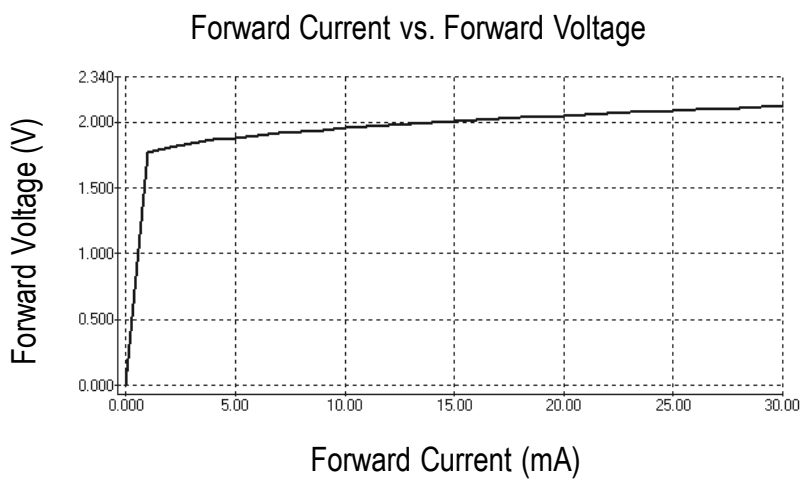
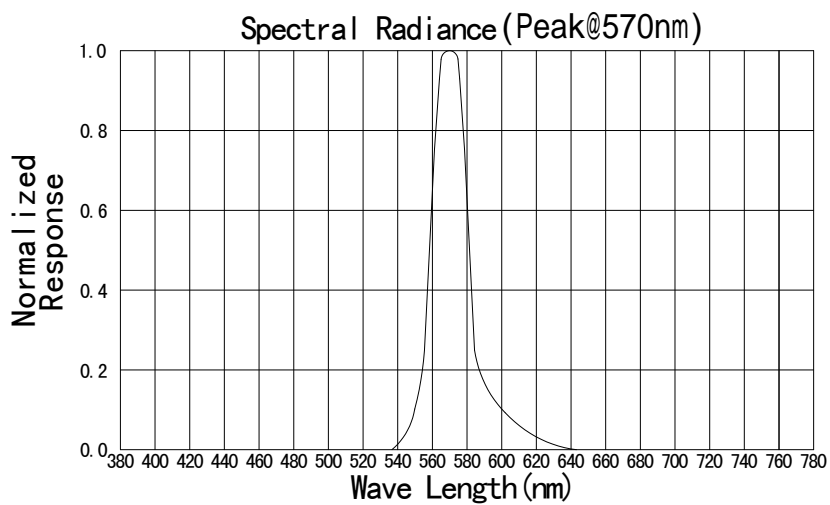

Reflow Profile

■ Reflow Temp/Time

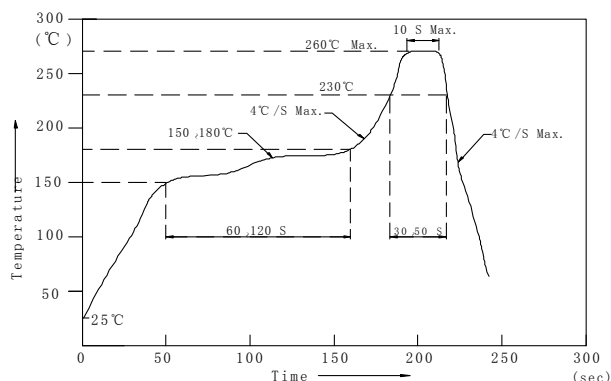

Notes:

1. We recommend the reflow temperature $245^{\circ}\text{C} (\pm 5^{\circ}\text{C})$. the maximum soldering temperature should be limited to 260°C .
2. Don't cause stress to the epoxy resin while it is exposed to high temperature.
3. Number of reflow process shall be 2 times or less.

■ Soldering iron

Basic spec is $\leq 5\text{sec}$ when 260°C . If temperature is higher, time should be shorter ($+10^{\circ}\text{C} \rightarrow -1\text{sec}$). Power dissipation of iron should be smaller than 20W, and temperatures should be controllable. Surface temperature of the device should be under 230°C .

■ Rework

1. Customer must finish rework within 5 sec under 260°C .
2. The head of iron can not touch copper foil
3. Twin-head type is preferred.

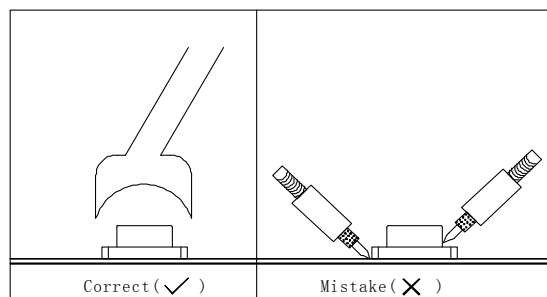

- Avoid rubbing or scraping the resin by any object, during high temperature, for example reflow solder etc.

Test circuit and handling precautions

■ Test circuit

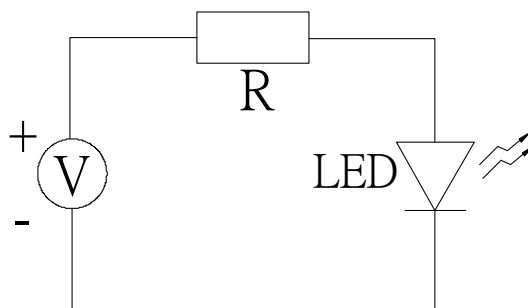

■ Handling precautions

1. Over-current-proof

Customer must apply resistors for protection; otherwise slight voltage shift will cause big current change (Burn out will happen).

2. Storage

2.1 It is recommended to store the products in the following conditions:

Humidity: 60% R.H. Max.

Temperature : 5°C~30°C(41°F~86°F)

2.2 Shelf life in sealed bag: 12 month at <5°C~30°C and <30% R.H. after the package is Opened, the products should be used within a week or they should be keeping to stored at ≤ 20 R.H. with zip-lock sealed.

3. Baking

It is recommended to baking before soldering when the pack is unsealed after 72hrs. The Conditions are as followings:

3.1 $60 \pm 3^\circ\text{C}$ x(12~24hrs) and <5%RH, taped reel type

3.2 $100 \pm 3^\circ\text{C}$ x(45min~1hr), bulk type

3.3 $130 \pm 3^\circ\text{C}$ x(15~30min), bulk type

Test items and results of reliability

Type	Test Item	Test Conditions	Note	Number of Damaged
Environmental Sequence	Temperature Cycle	-40°C 30min ↑ ↓ 80°C 30min	100 cycle	0/22
	Thermal Shock	-40°C 15min ↑ ↓ 80°C 15min	100 cycle	0/22
	High Humidity Heat Cycle	30°C ↔ 65°C 90%RH 24hrs/1cycle	10 cycle	0/22
	High Temperature Storage	Ta=80°C	1000 hrs	0/22
	Humidity Heat Storage	Ta=60°C RH=90%	1000 hrs	0/22
	Low Temperature Storage	Ta=-40°C	1000 hrs	0/22
Operation Sequence	Life Test	Ta=25°C IF=20mA	1000 hrs	0/22
	High Humidity Heat Life Test	60°C RH=90% IF=10mA	500 hrs	0/22
	Low Temperature Life Test	Ta=-40°C IF=20mA	1000 hrs	0/22

1615 Series SMD Chip LED Lamps Packaging Specifications

- Packaging specifications

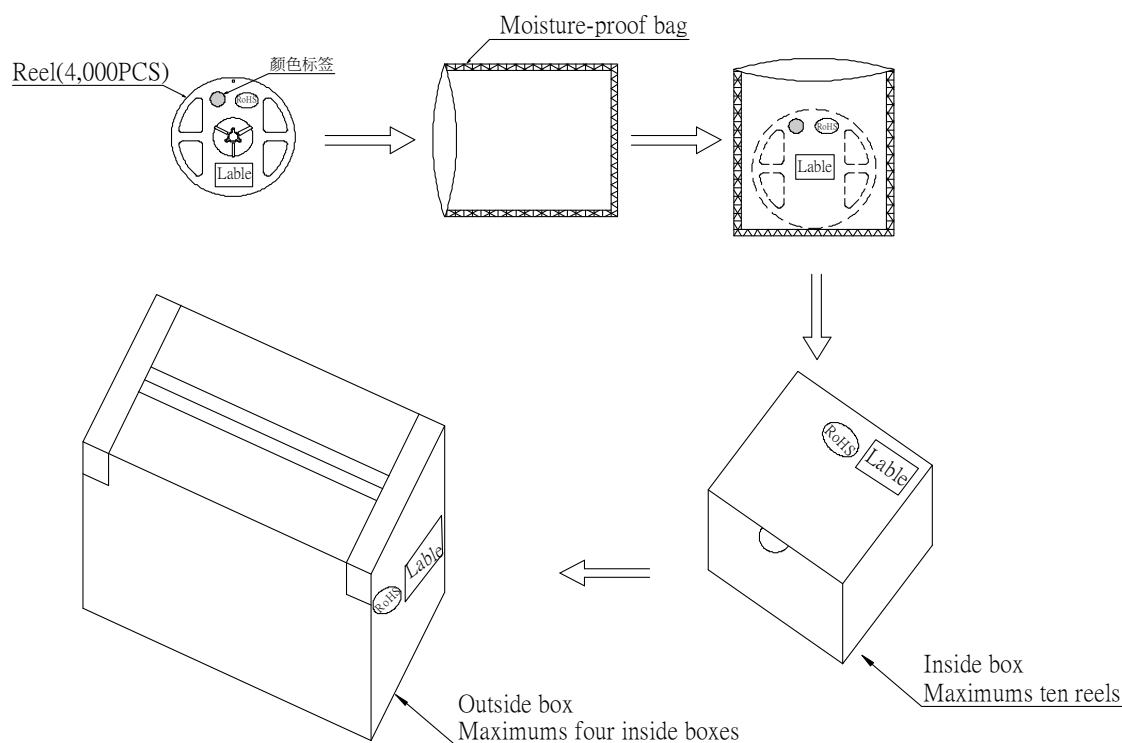

Notes:

Reeled products (numbers of products are 4,000pcs) packed in a seal off moisture-proof bag along with a desiccant one by one, ten moisture-proof bag of maximums (total maximum number of products are 40,000pcs) packed in an inside box (about size: 240x 220x 120mm) and four inside boxes of maximums are put in the outside box (about size: 460mm x 246mm x 250mm) Together with buffer material, and it is packed. (Part No., Lot No., quantity should appear on the label on the moisture-proof bag, part No. And quantity should appear on the label on the cardboard box.) The number of the loading steps of outside box (cardboard box) has it to three steps.