

Single N-Channel Enhancement Mode MOSFET

Feature Description

- 40V/135A
 $R_{DS(ON)} = 1.7m\Omega$ (typ.) @ $V_{GS} = 10V$
 $R_{DS(ON)} = 2.3m\Omega$ (typ.) @ $V_{GS} = 4.5V$
- 100% Avalanche Tested
- Reliable and Rugged
- Halogen- Free Devices Available

Pin Description

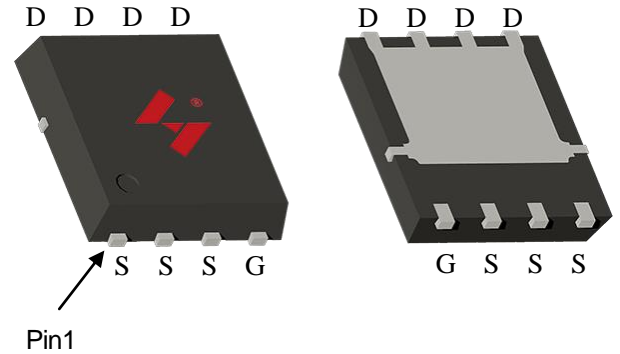

PDFN5*6-8L

Applications

- Switching Application
- Power Management for DC/DC
- Battery Protection

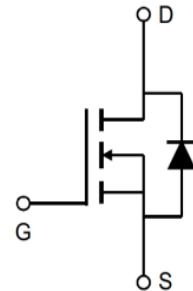

Single N-Channel MOSFET

Ordering and Marking Information

 C2 G017N04 XYMXXXXXX	Package Code C2: PDFN5*6-8L Date Code XYMXXXXXX
---	--

Note: HUAYI lead-free products contain molding compounds/die attach materials and 100% matte tin plate Termination finish; which are fully compliant with RoHS. HUAYI lead-free products meet or exceed the lead-free requirements of IPC/JEDEC J-STD-020 for MSL classification at lead-free peak reflow temperature. HUAYI defines “Green” to mean lead-free (RoHS compliant) and halogen free (Br or Cl does not exceed 900ppm by weight in homogeneous material and total of Br and Cl does not exceed 1500ppm by weight).

HUAYI reserves the right to make changes, corrections, enhancements, modifications, and improvements to this product and/or to this document at any time without notice.

Absolute Maximum Ratings

Symbol	Parameter	Rating	Unit	
Common Ratings (Tc=25°C Unless Otherwise Noted)				
V _{DSS}	Drain-Source Voltage	40	V	
V _{GSS}	Gate-Source Voltage	±20	V	
T _J	Junction Temperature Range	-55 to 175	°C	
T _{STG}	Storage Temperature Range	-55 to 175	°C	
I _S	Source Current-Continuous(Body Diode)	Tc=25°C	135	A
Mounted on Large Heat Sink				
I _{DM}	Pulsed Drain Current *	Tc=25°C	500	A
I _D	Continuous Drain Current	Tc=25°C	135	A
		Tc=100°C	95	A
P _D	Maximum Power Dissipation	Tc=25°C	75	W
		Tc=100°C	37.5	W
R _{θJC}	Thermal Resistance, Junction-to-Case		2	°C/W
R _{θJA}	Thermal Resistance, Junction-to-Ambient **		45	°C/W
E _{AS}	SinglePulsed-Avalanche Energy ***	L=0.3mH	359	mJ

Note: * Repetitive rating; pulse width limited by max.junction temperature.

** Surface mounted on FR-4 board.

*** Limited by T_{Jmax}, starting T_J=25°C, L = 0.3mH, R_θ= 25Ω, V_{GS}=10V.

Electrical Characteristics(Tc =25°C Unless Otherwise Noted)

Symbol	Parameter	Test Conditions	HYG017N04LS1			Unit
			Min	Typ.	Max	
Static Characteristics						
BV _{DSS}	Drain-Source Breakdown Voltage	V _{GS} =0V, I _{DS} =250μA	40	-	-	V
I _{DSS}	Drain-to-Source Leakage Current	V _{DS} =40V, V _{GS} =0V	-	-	1	μA
		T _J =125°C	-	-	50	μA
V _{GS(th)}	Gate Threshold Voltage	V _{DS} =V _{GS} , I _{DS} =250μA	1.0	1.8	3.0	V
I _{GSS}	Gate-Source Leakage Current	V _{GS} =±20V, V _{DS} =0V	-	-	±100	nA
R _{DS(ON)*}	Drain-Source On-State Resistance	V _{GS} =10V, I _{DS} =20A	-	1.7	2.1	mΩ
		V _{GS} =4.5V, I _{DS} =20A	-	2.3	2.8	
Diode Characteristics						
V _{SD*}	Diode Forward Voltage	I _{SD} =20A, V _{GS} =0V	-	0.77	1.2	V
t _{rr}	Reverse Recovery Time	I _{SD} =20A, dI _{SD} /dt=100A/μs	-	33.8	-	ns
Q _{rr}	Reverse Recovery Charge		-	32.7	-	nC

Electrical Characteristics (Cont.) (T_c =25°C Unless Otherwise Noted)

Symbol	Parameter	Test Conditions	HYG017N04LS1			Unit
			Min	Typ.	Max	
Dynamic Characteristics						
R _G	Gate Resistance	V _{GS} =0V, V _{DS} =0V, Frequency=1.0MHz	-	1.1	-	Ω
C _{iss}	Input Capacitance	V _{GS} =0V, V _{DS} =25V, Frequency=1.0MHz	-	4332	-	pF
C _{oss}	Output Capacitance		-	813	-	
C _{rss}	Reverse Transfer Capacitance		-	50	-	
t _{d(ON)}	Turn-on Delay Time	V _{DD} =20V, R _G =2.5Ω, I _{DS} =20A, V _{GS} =10V	-	15	-	ns
T _r	Turn-on Rise Time		-	41	-	
t _{d(OFF)}	Turn-off Delay Time		-	40	-	
T _f	Turn-off Fall Time		-	8	-	
Gate Charge Characteristics						
Q _g	Total Gate Charge (V _{GS} =10V)	V _{DS} =32V, I _D =20A	-	66.1	-	nC
Q _g	Total Gate Charge (V _{GS} =4.5V)		-	31.3	-	
Q _{gs}	Gate-Source Charge		-	16.3	-	
Q _{gd}	Gate-Drain Charge		-	10.5	-	

Note: *Pulse test, pulse width ≤ 300us, duty cycle ≤ 2%

Typical Operating Characteristics

Figure 1: Power Dissipation

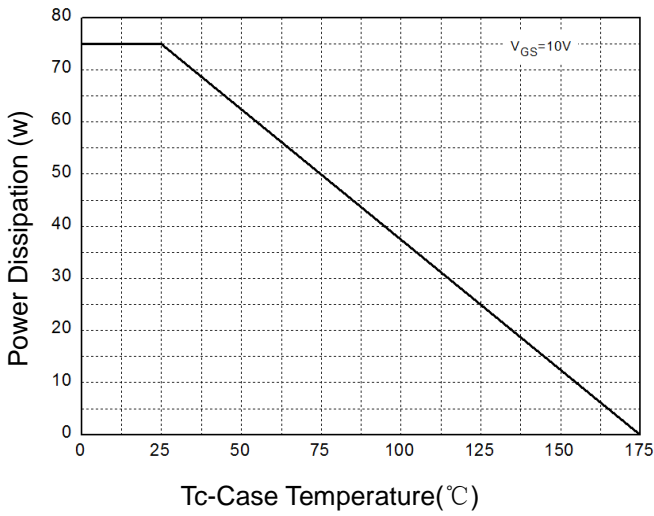

Figure 2: Drain Current

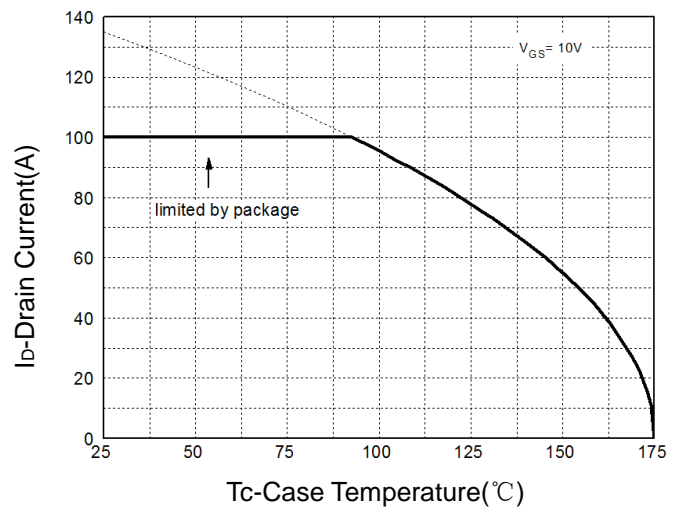

Figure 3: Safe Operation Area

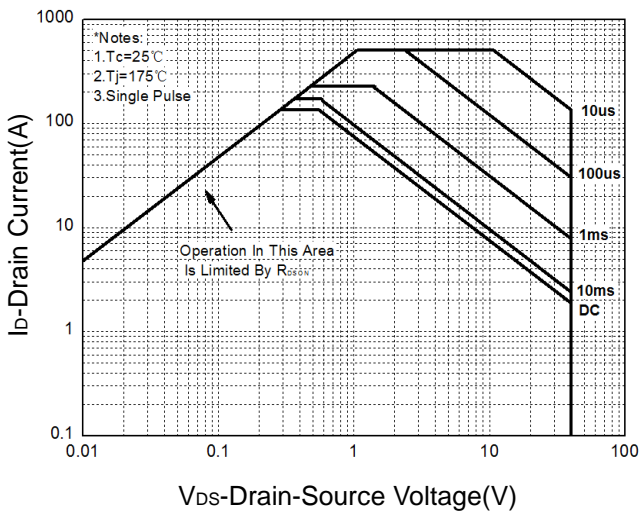

Figure 4: Thermal Transient Impedance

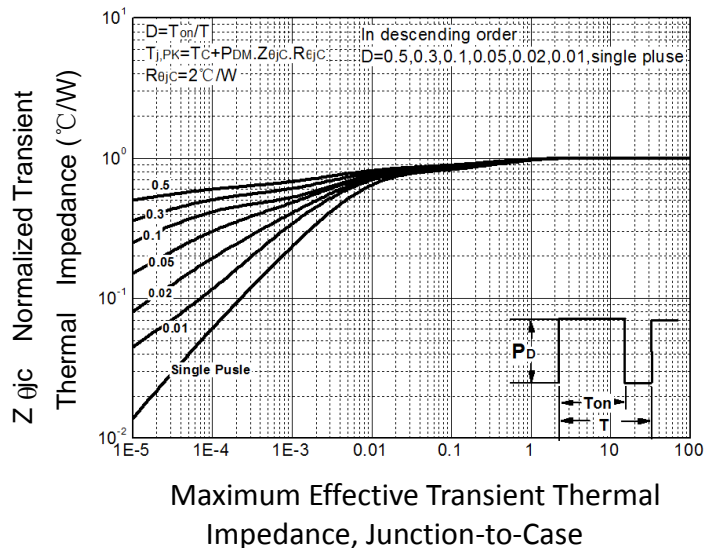

Figure 5: Output Characteristics

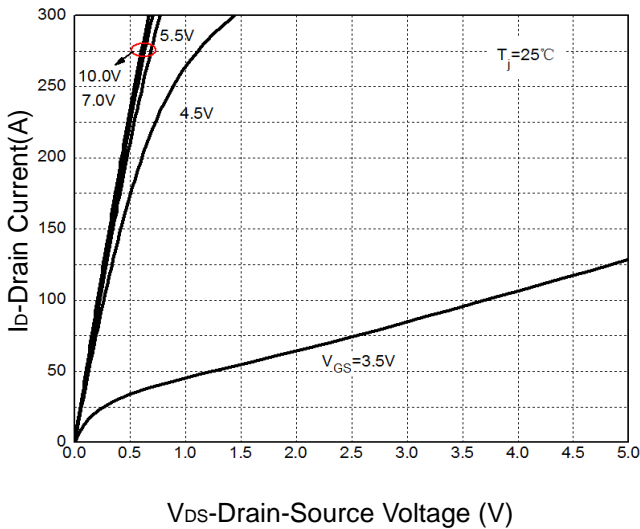
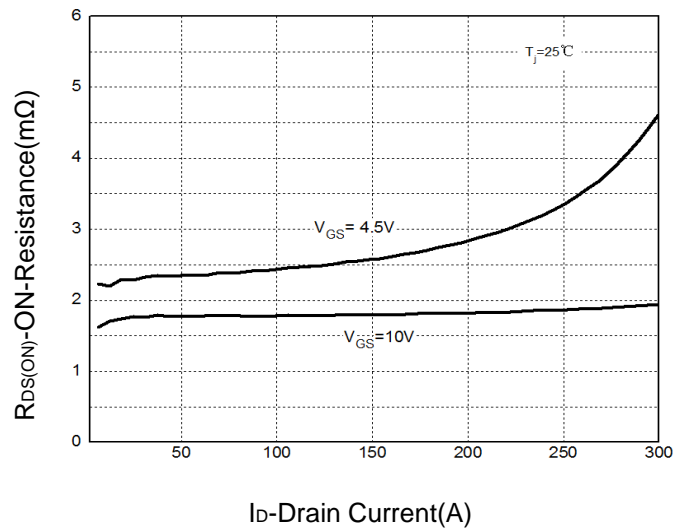

Figure 6: Drain-Source On Resistance



Typical Operating Characteristics(Cont.)

Figure 7: On-Resistance vs. Temperature

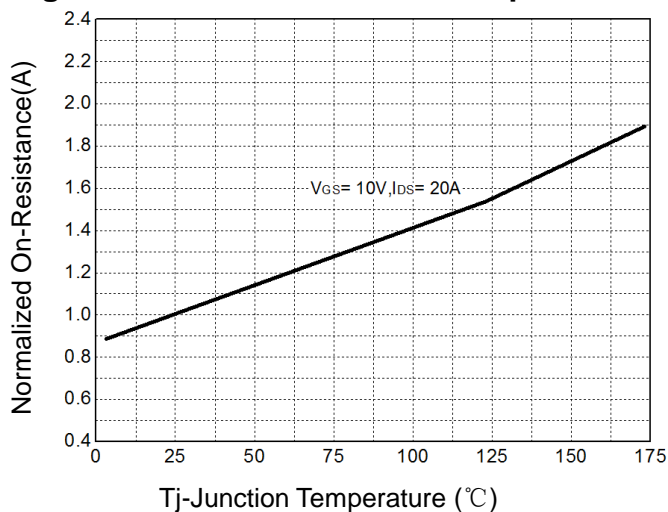

Figure 8: Source-Drain Diode Forward

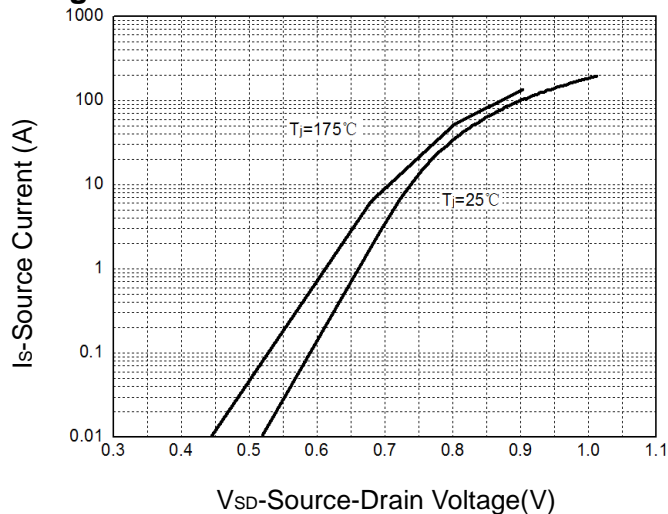

Figure 9: Capacitance Characteristics

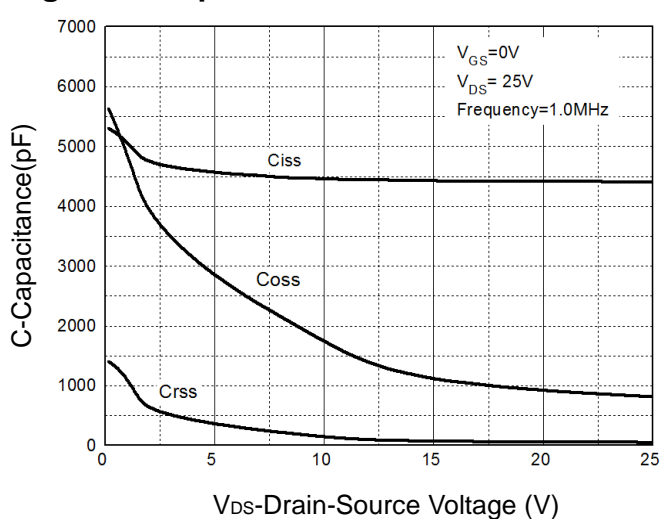
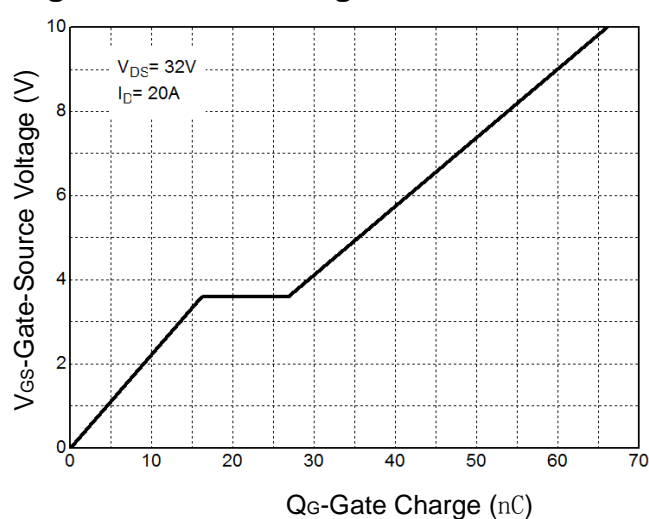
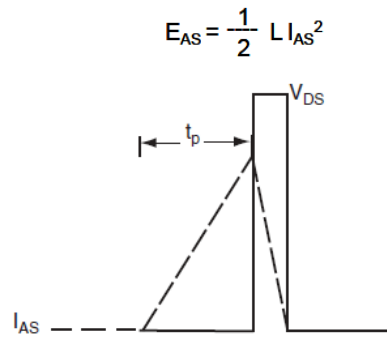
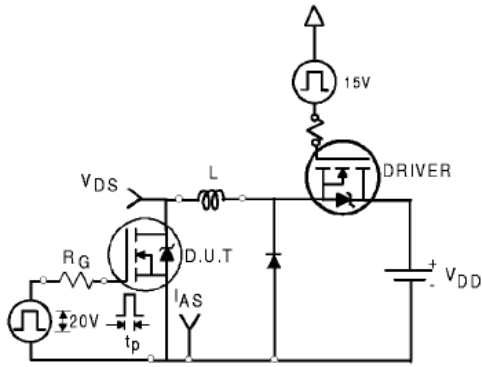

Figure 10: Gate Charge Characteristics



Avalanche Test Circuit



Switching Time Test Circuit

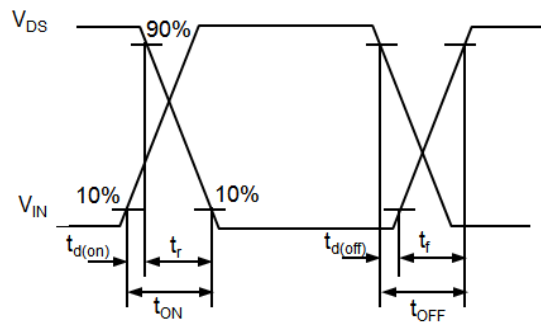
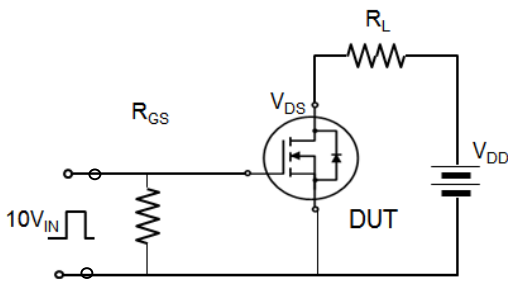

Gate Charge Test Circuit

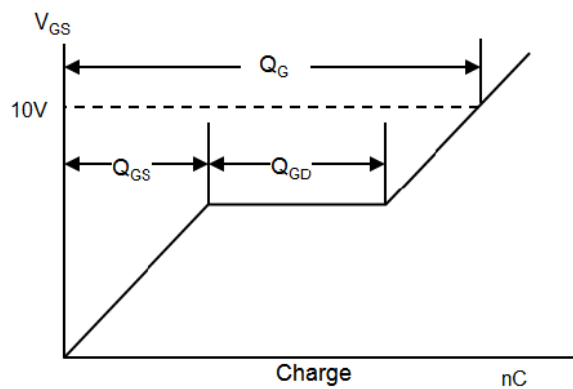
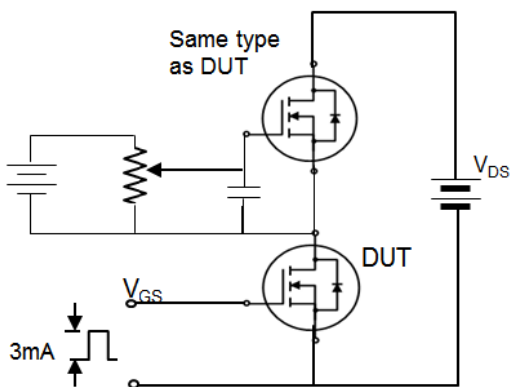

Device Per Unit

Package Type	Unit	Quantity
PDFN5*6-8L	Reel	5000

Package Information

PDFN5*6-8L

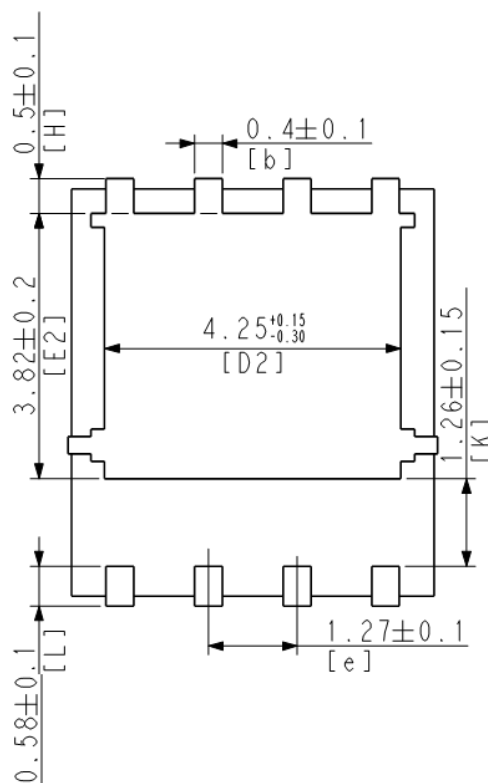
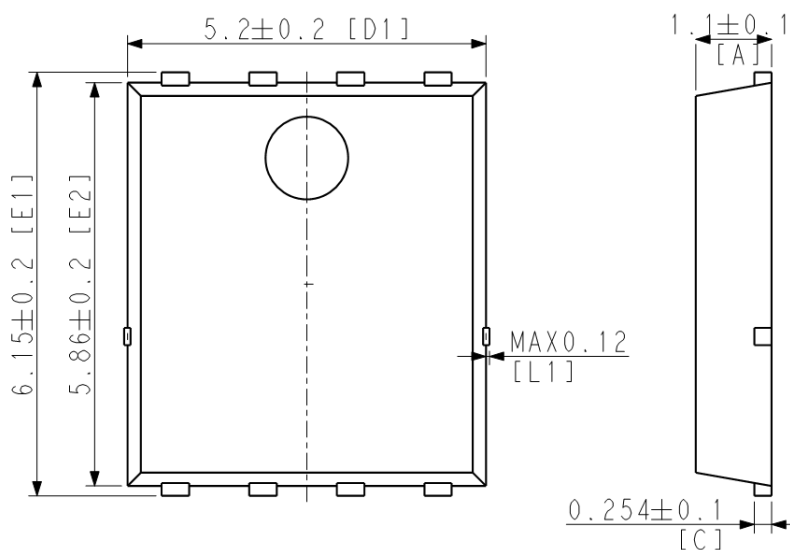

Classification Profile

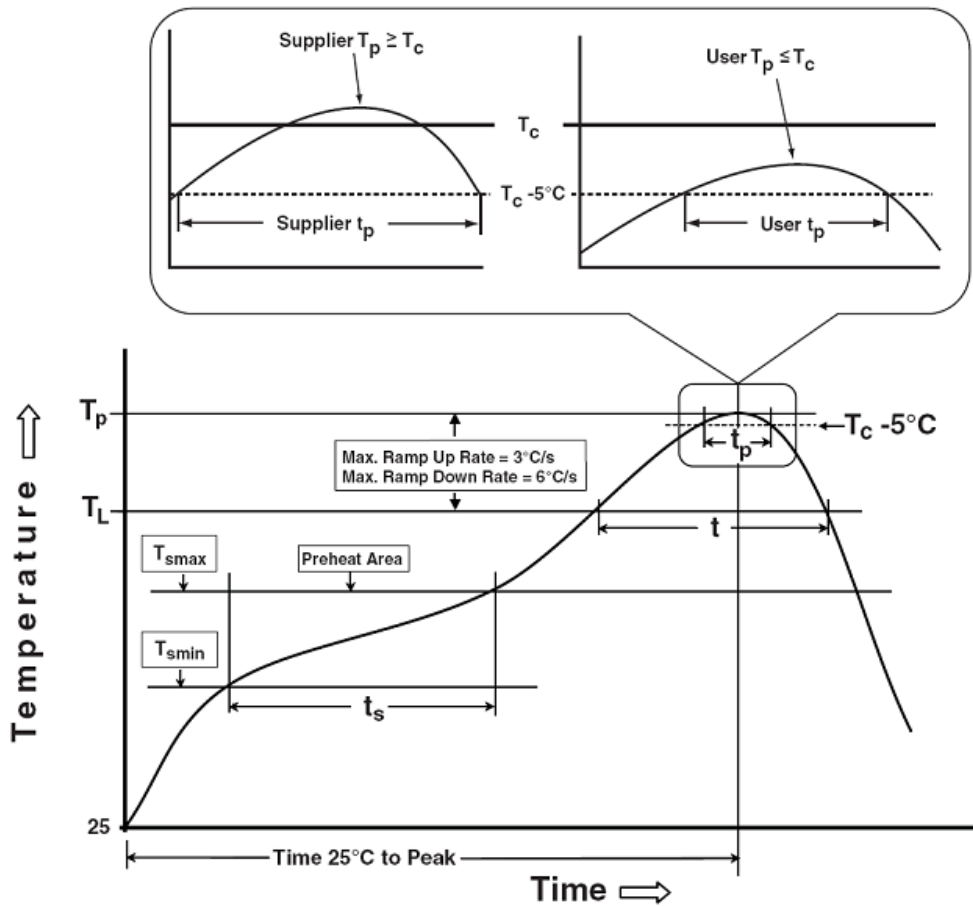

Classification Reflow Profiles

Profile Feature	Sn-Pb Eutectic Assembly	Pb-Free Assembly
Preheat & Soak		
Temperature min (T_{smin})	100 °C	150 °C
Temperature max (T_{smax})	150 °C	200 °C
Time (T_{smin} to T_{smax}) (t_s)	60-120 seconds	60-120 seconds
Average ramp-up rate (T_{smax} to T_p)	3 °C/second max.	3°C/second max.
Liquidous temperature (T_L)	183 °C	217 °C
Time at liquidous (t_L)	60-150 seconds	60-150 seconds
Peak package body Temperature (T_p)*	See Classification Temp in table 1	See Classification Temp in table 2
Time (t_p)** within 5°C of the specified classification temperature (T_c)	20** seconds	30** seconds
Average ramp-down rate (T_p to T_{smax})	6 °C/second max.	6 °C/second max.
Time 25°C to peak temperature	6 minutes max.	8 minutes max.

*Tolerance for peak profile Temperature (T_p) is defined as a supplier minimum and a user maximum.

** Tolerance for time at peak profile temperature (t_p) is defined as a supplier minimum and a user maximum.

Table 1.SnPb Eutectic Process – Classification Temperatures (Tc)

Package Thickness	Volume mm ³ <350	Volume mm ³ ≥350
<2.5 mm	235 °C	220 °C
≥2.5 mm	220 °C	220 °C

Table 2.Pb-free Process – Classification Temperatures (Tc)

Package Thickness	Volume mm ³ <350	Volume mm ³ 350-2000	Volume mm ³ ≥2000
<1.6 mm	260 °C	260 °C	260 °C
1.6 mm – 2.5 mm	260 °C	250 °C	245 °C
≥2.5 mm	250 °C	245 °C	245 °C

Reliability Test Program

Test item	Method	Description
SOLDERABILITY	JESD-22, B102	5 Sec, 245°C
HTGB	JESD-22, A108	168/500/1000 Hrs, Bias @ 150°C
HTRB	JESD-22, A108	168/500/1000 Hrs, Bias @ 150°C
PCT	JESD-22, A102	96 Hrs, 100%RH, 2atm, 121°C
TCT	JESD-22, A104	500 Cycles, -55°C~150°C

Customer Service

Worldwide Sales and Service: sales@hymexa.com

Technical Support: Technology@hymexa.com

Huayi Microelectronics Co., Ltd.

No.8928,Shangji Road,Economic and Technological Development Zone,Xi'an,China

TEL: (86-029) 86685706

FAX: (86-029) 86685705

E-mail: sales@hymexa.com

Web net: www.hymexa.com