

# 1CH ADJ Current-Limited Power Distribution Switch

## Features

- Single-Channel Power Distribution Switch
- Programmable Current Limit in 0.4A~2A Output Current
- Enable polarity: Active High
- 2.4V to 5.5V Supply Range
- Under-Voltage Lockout
- -40°C to +85°C Ambient Temperature Range
- Accurate Current Limit
- 15 $\mu$ A Quiescent Current
- 80m $\Omega$  MOSFET
- Thermal-Shutdown Protection
- Built-In Soft Start
- Reverse Current Blocking (No Body Diode)
- Available in SOT23-5 Package

## Applications

- Set-Top Boxes
- Wi-Fi Router/AP
- USB 3G Datacard/ USB Dongle
- ONT Boxes
- USB Ports and Hubs, Laptops, and Desktops
- Smartphone and PDA
- MiniPCI Accessories

## General Description

The BL2555 Power Distribution Switch features internal current limiting to prevent damage to host devices due to faulty load conditions. The BL2555 develops ultra-low on-resistance switch with programmable current limiting to protect the power source from over current and short circuit conditions. It integrates the over temperature protection and discharges the output capacitor during the shutdown. In case the output is pulled higher than the input voltage under the shutdown, the BL2555 can block the current flowing from the output to the input. The BL2555 is available in SOT23-5 package.

## Typical Application Circuit

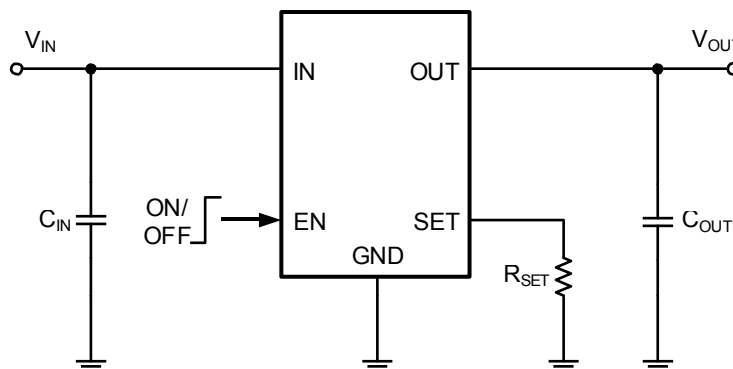

Basic Application Circuit

# 1CH ADJ Current-Limited Power Distribution Switch

## Pin Description

## Pin Configuration

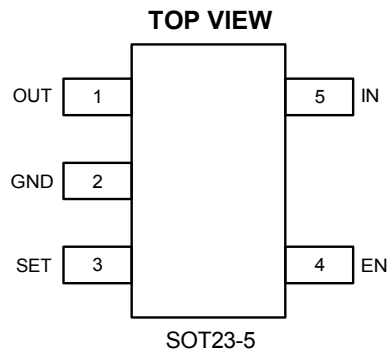

## Pin Description

Pin	Name	Function
1	OUT	Output Pin.
2	GND	Ground Pin.
3	SET	Current limit programming Pin. Connect a resistor $R_{SET}$ from this pin to GND to program the current limit.
4	EN	ON/OFF control. Pull high to enable IC, Do not float.
5	IN	Power Supply Pin

## Order Information

Model	Package	MOQ
BL2555	SOT23-5	3000PCS

# 1CH ADJ Current-Limited Power Distribution Switch

## Absolute Maximum Ratings <sup>(1)</sup> <sup>(2)</sup> <sup>(3)</sup>

All Pins Voltage .....	-0.3V to +6V
Operating Virtual Junction (T <sub>j</sub> ) .....	-40°C to +150°C
Ambient Temperature Operating Range (T <sub>A</sub> ) .....	-40°C to +85°C
Storage Temperature Range (T <sub>S</sub> ) .....	-55°C to +150°C
Lead Temperature (Soldering, 10s) (T <sub>L</sub> ) .....	+260°C
Junction-to-ambient thermal resistance (R <sub>θJA</sub> ) .....	200°C/W
Junction-to-case thermal resistance (R <sub>θJC</sub> ) .....	130°C/W

Note 1: Exceeding these ratings may damage the device.

Note 2: The device is not guaranteed to function outside of its operating conditions.

Note 3: θ<sub>JA</sub> is measured in the natural convection at T<sub>A</sub> = 25°C on a low effective single layer thermal conductivity test board of JEDEC 51-3 thermal measurement standard. Pin 2 of SOT23-5 packages is the case position for θ<sub>JC</sub> measurement.

## Recommended Operating Conditions

Input Voltage Pin .....	+2.4V to +5.5V
All Other Pins .....	0V to +5.5V
Junction Temperature Range (T <sub>j</sub> ) .....	-40°C to +125°C
Ambient Temperature Range (T <sub>A</sub> ) .....	-40°C to +85°C

## Electrical Characteristics

(V<sub>IN</sub> = 5V, C<sub>L</sub> = 1μF, per channel, T<sub>A</sub> = 25°C unless otherwise specified)

Parameter	Symbol	Test Conditions	Min	Typ.	Max	Unit
Input Voltage Range	V <sub>IN</sub>		2.4		5.5	V
Shutdown Input Current	I <sub>SHDN</sub>	Open load, IC Disabled		0.1	1	μA
Quiescent Supply Current	I <sub>Q</sub>	Open load, IC Enabled		15		μA
FET RON	R <sub>DS(ON)1</sub>			80		mΩ
ENB Rising Threshold	V <sub>ENB(H)</sub>		2			V
ENB Falling Threshold	V <sub>ENB(L)</sub>				0.8	V
ENB Leakage	I <sub>ENB</sub>	V <sub>ENB</sub> = 5.5V			1	μA
IN UVLO Threshold	V <sub>IN,UVLO</sub>	Minimum Duty Cycle			2.3	V
IN UVLO Hysteresis	V <sub>IN,HYS</sub>			0.1		V
Over Current Limit	I <sub>LIM</sub>	R <sub>SET</sub> = 6.8kΩ	0.75	1.0	1.25	A
	I <sub>LIM(MIN)</sub>			0.4		A
	I <sub>LIM(MAX)</sub>			2		A
Thermal Shutdown Temperature	T <sub>SD</sub>			130		°C
Thermal Shutdown Hysteresis	T <sub>HYS</sub>			20		°C

# 1CH ADJ Current-Limited Power Distribution Switch

## Typical Performance Characteristics (4) (5)

Note (4): Performance waveforms are tested on the evaluation board.

Note (5):  $V_{IN} = 5V$ ,  $C_{OUT} = 1\mu F$ ,  $R_{SET} = 6.8k\Omega$ ,  $T_A = +25^\circ C$ , unless otherwise noted.

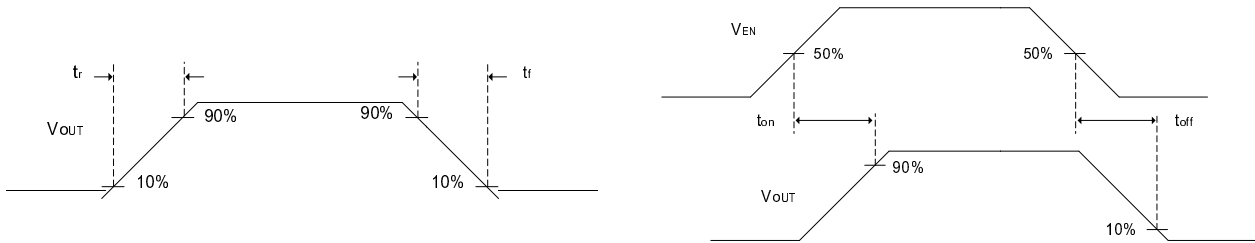

**Figure 1 Tr, Tf, Ton, Toff waveforms**

### Turn on Delay vs. Input Voltage

$V_{EN}=5V$ ,  $R_{LOAD}=5\Omega$

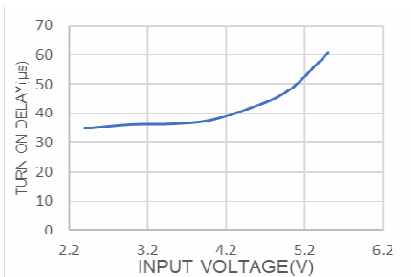

### Turn off Delay vs. Input Voltage

$V_{EN}=5V$ ,  $R_{LOAD}=5\Omega$

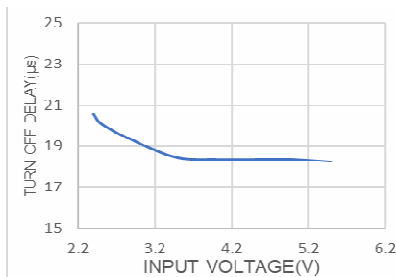

### Supply Current, Output Enabled vs. Input Voltage

$V_{EN} = 5V$

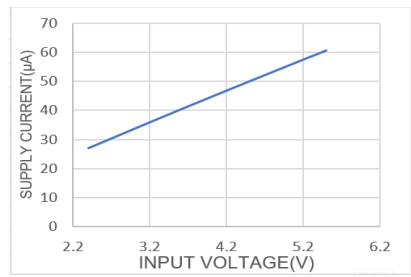

### Supply Current, Output Disabled vs. Input Voltage

$V_{EN} = 0V$

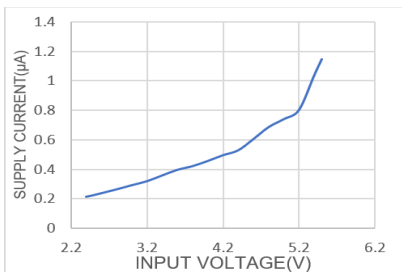

### Static Drain-Source On-State Resistance vs. Input Voltage

$V_{EN} = 5V$ ,  $I_{LOAD}=0.5A$

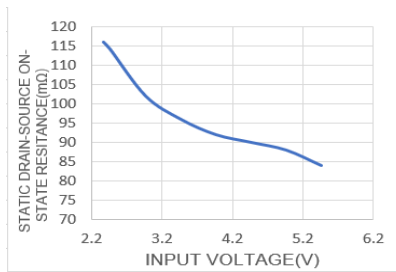

### Input to Output Voltage vs. Load Current

$V_{EN} = 5V$

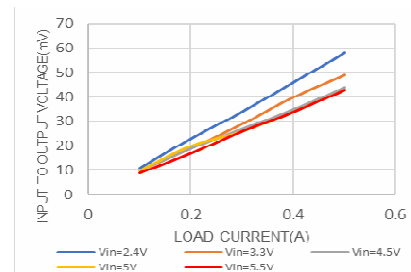

# 1CH ADJ Current-Limited Power Distribution Switch

**Current Limit vs. Input Voltage**

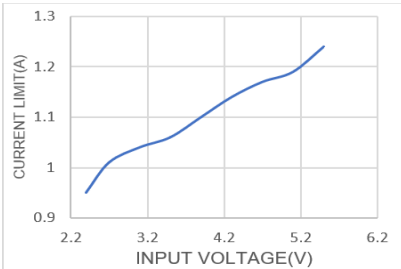

**Threshold Trip Current vs. Input Voltage**

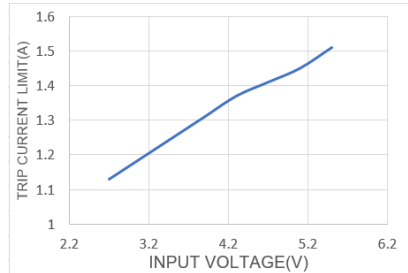

**Current Limit vs. R<sub>SET</sub>**

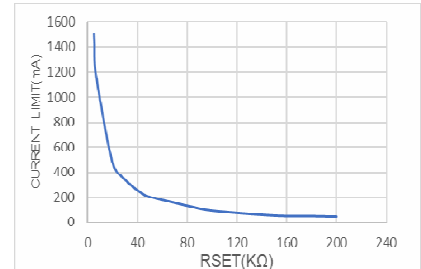

**Turn on Delay Rise Time**

V<sub>EN</sub> = 5V, R<sub>LOAD</sub> = 5Ω

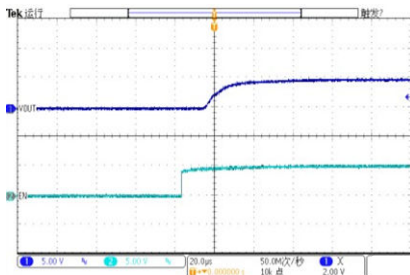

**Turn off Delay Fall Time**

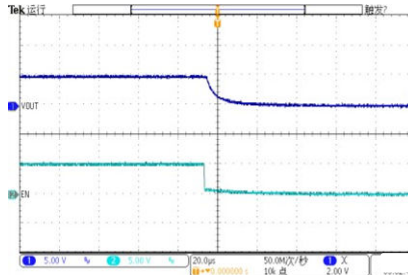

**Threshold Trip Current with Ramped Load Enabled Device**

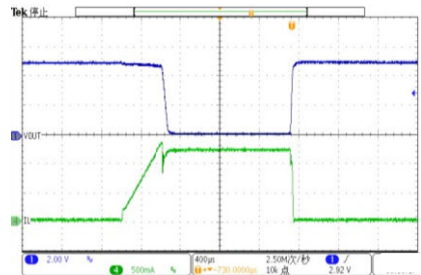

**1Ω Load Connected to Enabled Device**

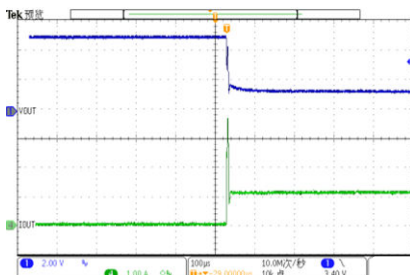

**Short Circuit Current, Device Enabled into Short**

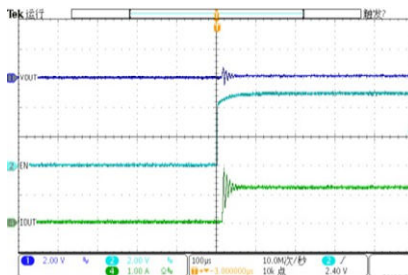

**Current Limit vs. R<sub>SET</sub>**  
I<sub>LIM</sub> = 0.4~1.5A

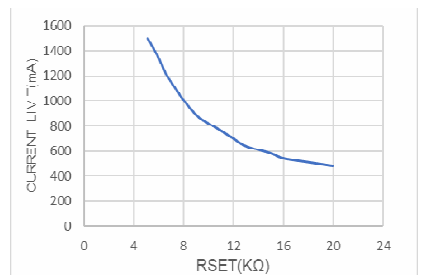

# 1CH ADJ Current-Limited Power Distribution Switch

## Function Block Diagram

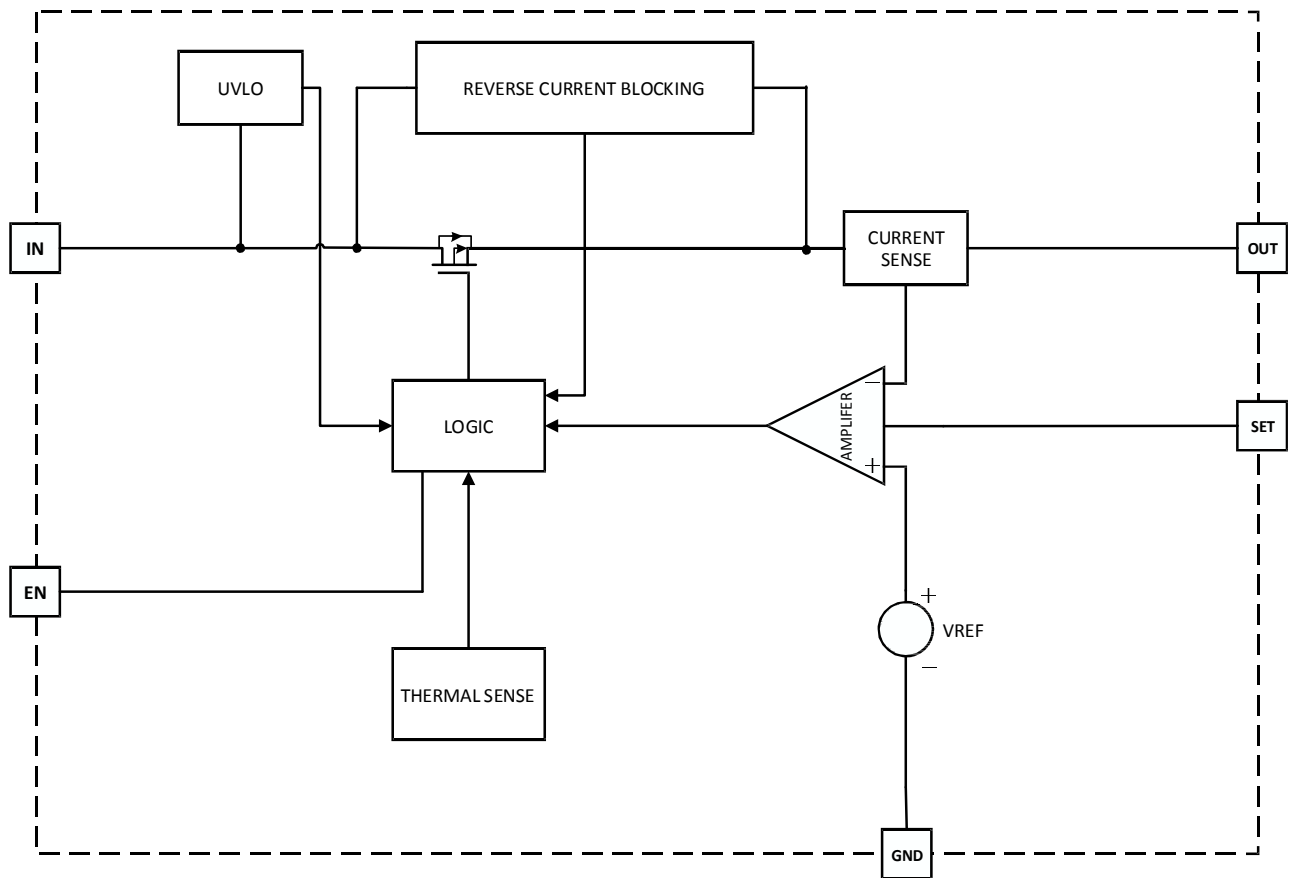

Figure 2 Function Block Diagram

# 1CH ADJ Current-Limited Power Distribution Switch

## Functions Description

### Current Limit

The BL2555 provides a constant current limit that can be programmed by an external resistor. Once the device reaches its current limit threshold, the internal circuit regulates the gate voltage to hold the current in the power MOSFET constant. Below table can be taken as a reference to choose  $R_{SET}$  to set the current limit threshold.

$R_{SET}$ (k $\Omega$ )	Typical Current Limit (mA)
5.1	1360
5.6	1250
6.8	1020
7.5	930
8.2	870
10	730
12	615
15	500
18	420
30	260
51	160
82	100
100	88

**Table 1 Current Limit Threshold Setting**

### Over Current

When the load exceeds trip current (minimum threshold current triggering constant-current mode) or short circuited, BL2555 switches into to constant-current mode (current limit value). BL2555 will be shut down only if the overcurrent condition stays long enough to trigger thermal protection.

Trigger overcurrent protection for different overload conditions occurring in applications:

- 1) The output has been shorted or overloaded before the device is enabled or input applied. BL2555 detects the short or overload and immediately switches into a constant-current mode.
- 2) A short or an overload occurs after the device is enabled. The device switches into constant current mode after the current-limit circuit has been tripped (reached the trip current threshold). However, high current may flow for a

---

## 1CH ADJ Current-Limited Power Distribution Switch

short period of time before the current-limit circuit can react.

3) Output current has been gradually increased beyond the recommended operating current. The load current rises until the trip current threshold is reached or until the thermal limit of the device is exceeded. Once the trip threshold has been reached, the device switches into its constant-current mode.

### **Thermal Protection**

If the current limit block starts to regulate the output current, the power loss on power MOSFET will cause the IC temperature rise. The die temperature is internally monitored until the thermal limit is reached. Once this temperature is reached, the switch will turn off to allow the chip to cool until the over temperature fault remove. The over temperature threshold is 130°C and hysteresis is 20°C.

### **Under-voltage Lockout (UVLO)**

This circuit is used to monitor the input voltage to ensure that the BL2555 is operating correctly. This UVLO circuit also ensures that there is no operation until the input voltage reaches the minimum spec.

### **Reverse Current Blocking**

In case the output is pulled higher than the input voltage under the shutdown, the BL2555 can block the current flowing from the output to the input. This prevents damage to devices on the input side of the BL2555 by preventing significant current from sinking into the input capacitance.

### **Output Discharge**

BL2555 has output discharge function. It can discharge the output capacitor by internal pulldown resistance during shutdown.



# 1CH ADJ Current-Limited Power Distribution Switch

## Package Description

### SOT23-5

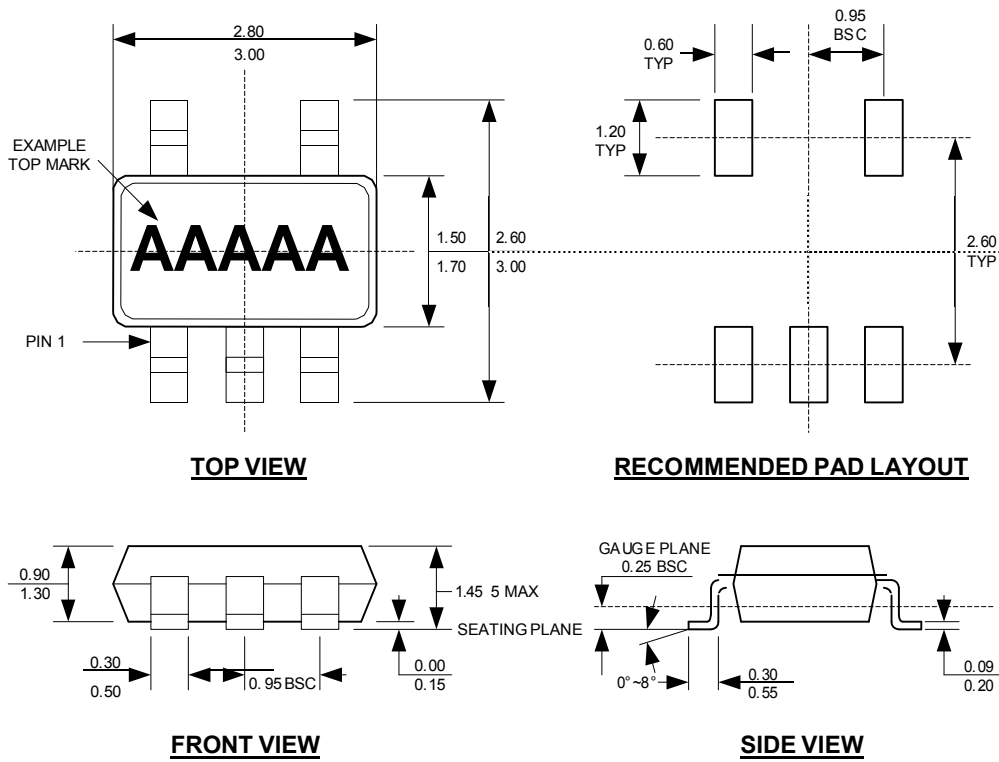

**NOTE:**

1. CONTROL DIMENSION IS IN INCHES. DIMENSION IN BRACKET IS IN MILLIMETERS.
2. PACKAGE LENGTH DOES NOT INCLUDE MOLD FLASH, PROTRUSIONS OR GATE BURRS.
3. PACKAGE WIDTH DOES NOT INCLUDE INTERLEAD FLASH OR PROTRUSIONS.
4. LEAD COPLANARITY (BOTTOM OF LEADS AFTER FORMING) SHALL BE 0.004" INCHES MAX.
5. DRAWING CONFORMS TO JEDEC MS-012, VARIATION BA.
6. DRAWING IS NOT TO SCALE.