

MSKSEMI

SEMICONDUCTOR

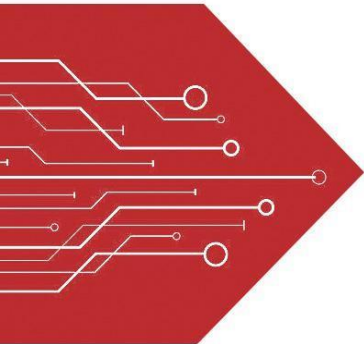

ESD



TVS



TSS



MOV



GDT



PLED

Product data sheet

Feature

- 350 W Peak Power per Line ($t_p = 8/20\mu s$)
- SOT-143 package
- ESD Protection > 15 kV
- Unidirectional configurations
- Protects 2 I/O Ports & Power Supply
- Low Capacitance: 4 pF
- Low clamping voltage
- RoHS Compliant in Lead-Free Versions
- Transient protection for data lines to IEC 61000-4-2(ESD)
- $\pm 15KV(\text{air}) \pm 8KV(\text{contact});$ IEC 61000-4-4 (EFT) 40A (5/50ns)

Mechanical Characteristics

- Lead finish:100% matte Sn(Tin)
- Mounting position: Any
- Qualified max reflow temperature:260°C
- Device meets MSL 1 requirements
- Pure tin plating: 7 ~ 17 μm
- Pin flatness : $\leq 3\text{mil}$

Applications

- Ethernet - 10/100 Base T
- Fire wire
- Wireless communications
- USB interface

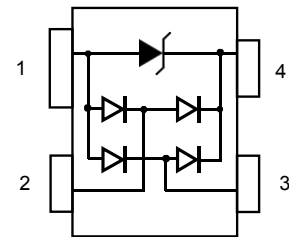

SOT-143

Electrical characteristics per line@(unless otherwise specified)

Parameter	Symbol	Conditions	Min.	Typ.	Max.	Units
Reverse Stand-off Voltage	V_{RWM}				5	V
Reverse Breakdown Voltage	V_{BR}	$I_t = 1\text{mA}$	6		8.5	V
Reverse Leakage Current	I_R	$V_{RWM} = 5.0\text{V}, T = 25^\circ\text{C}$			1	μA
Clamping Voltage	V_C	$I_{PP} = 1\text{A}, t_p = 8/20\mu s$			12.5	V
Clamping Voltage	V_C	$I_{PP} = 5\text{A}, t_p = 8/20\mu s$			24.0	V
Capacitance Between IO and GND	C_J	$V_R = 0\text{V}, f = 1\text{MHz}$		3.0		pF
Capacitance Between IO and I/O	C_J	$V_R = 0\text{V}, f = 1\text{MHz}$		1.5		pF

Absolute maximum rating@25°C

Rating	Symbol	Value	Units
Peak Pulse Power ($t_p = 8/20\mu s$)	P_{pp}	350	W
Peak Pulse Power ($t_p = 8/20\mu s$)	I_{pp}	9	A
Operating Temperature	T_J	-55 to +150	°C
Storage Temperature	T_{STG}	-55 to +150	°C

Electronics Parameter

Symbol	Parameter
V_{RWM}	Peak Reverse Working Voltage
I_R	Reverse Leakage Current @ V_{RWM}
V_{BR}	Breakdown Voltage @ I_T
I_T	Test Current
I_{PP}	Maximum Reverse Peak Pulse Current
V_C	Clamping Voltage @ I_{PP}
P_{PP}	Peak Pulse Power
C_J	Junction Capacitance
I_F	Forward Current
V_F	Forward Voltage @ I_F

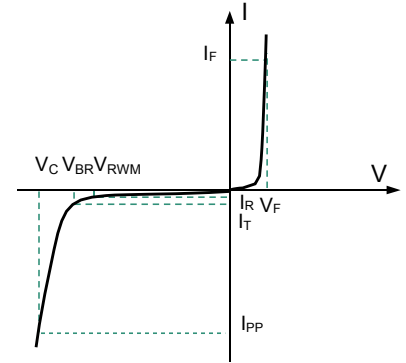

FIG1: Pulse Waveform

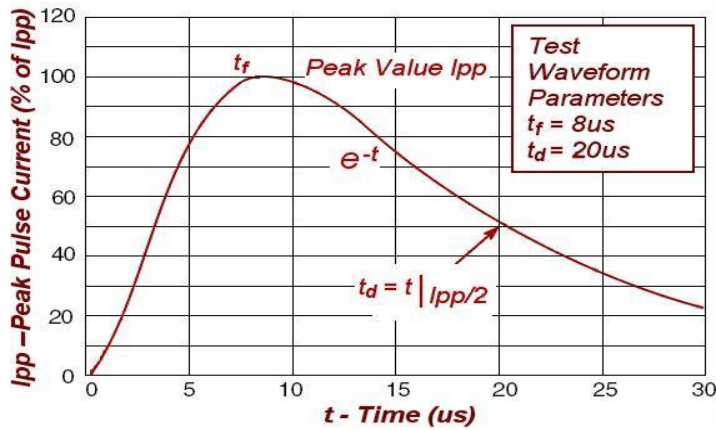
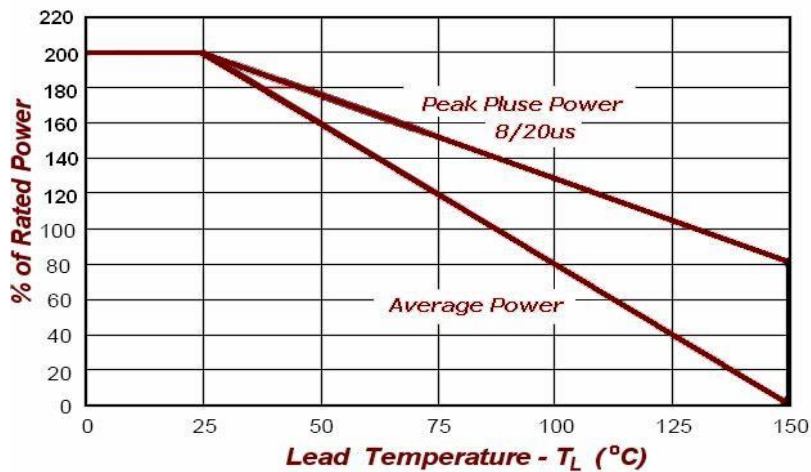
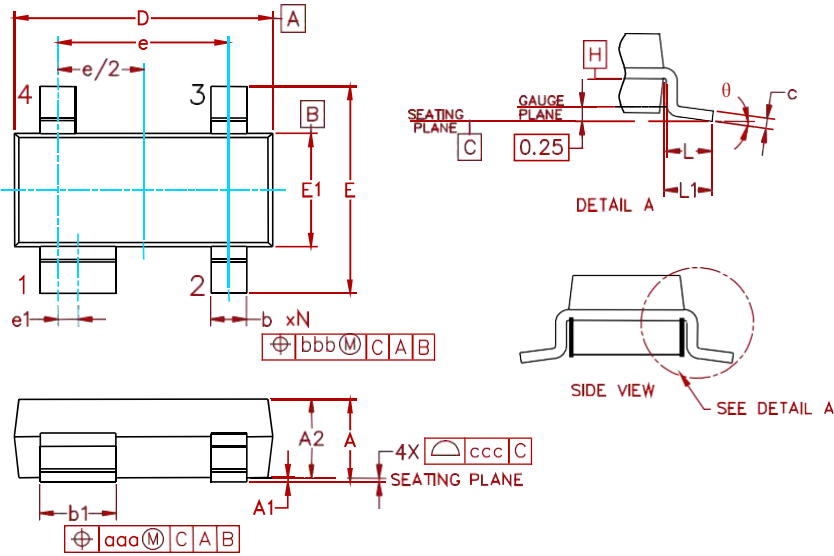

FIG2: Power Derating



PACKAGE MECHANICAL DATA



Symbol	Inches			Millimeters		
	Min.	Nom.	Max.	Min.	Nom.	Max.
A	0.031	-	0.048	0.80	-	1.22
A1	0.000	-	0.008	0.013	-	0.15
A2	0.020	0.035	0.042	0.75	0.90	1.07
b	0.011	-	0.020	0.30	-	0.51
b1	0.029	-	0.037	0.76	-	0.94
c	0.003	-	0.008	0.08	-	0.20
D	0.110	0.114	0.120	2.80	2.90	3.04
E	0.082	0.093	0.104	2.10	2.37	2.64
E1	0.047	0.051	0.055	1.20	1.30	1.40
e	0.075			1.92 BSC		
e1	0.008			0.20 BSC		
L	0.015	0.020	0.024	0.40	0.50	0.60
L1	(0.021)			(0.54)		
N	4			4		
θ	0°	-	8°	0°	-	8°
aaa	0.006			0.15		
bbb	0.008			0.20		
ccc	0.004			0.10		

Suggested Pad Layout

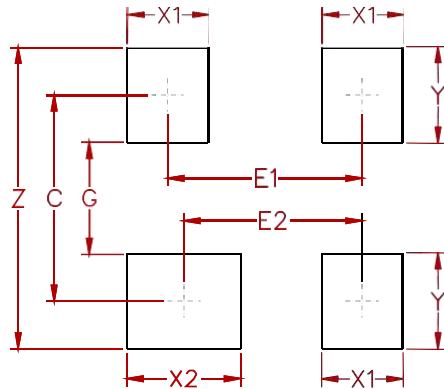

REEL SPECIFICATION

P/N	PKG	QTY
PRTR5V0U2X-MS	SOT-143	3000

Attention

- Any and all MSKSEMI Semiconductor products described or contained herein do not have specifications that can handle applications that require extremely high levels of reliability, such as life-support systems, aircraft's control systems, or other applications whose failure can be reasonably expected to result in serious physical and/or material damage. Consult with your MSKSEMI Semiconductor representative nearest you before using any MSKSEMI Semiconductor products described or contained herein in such applications.
- MSKSEMI Semiconductor assumes no responsibility for equipment failures that result from using products at values that exceed, even momentarily, rated values (such as maximum ratings, operating condition ranges, or other parameters) listed in products specifications of any and all MSKSEMI Semiconductor products described or contained herein.
- Specifications of any and all MSKSEMI Semiconductor products described or contained herein stipulate the performance, characteristics, and functions of the described products in the independent state, and are not guarantees of the performance, characteristics, and functions of the described products as mounted in the customer's products or equipment. To verify symptoms and states that cannot be evaluated in an independent device, the customer should always evaluate and test devices mounted in the customer's products or equipment.
- MSKSEMI Semiconductor strives to supply high-quality high-reliability products. However, any and all semiconductor products fail with some probability. It is possible that these probabilistic failures could give rise to accidents or events that could endanger human lives, that could give rise to smoke or fire, or that could cause damage to other property. When designing equipment, adopt safety measures so that these kinds of accidents or events cannot occur. Such measures include but are not limited to protective circuits and error prevention circuits for safe design, redundant design, and structural design.
- In the event that any or all MSKSEMI Semiconductor products (including technical data, services) described or contained herein are controlled under any of applicable local export control laws and regulations, such products must not be exported without obtaining the export license from the authorities concerned in accordance with the above law.
- No part of this publication may be reproduced or transmitted in any form or by any means, electronic or mechanical, including photocopying and recording, or any information storage or retrieval system, or otherwise, without the prior written permission of MSKSEMI Semiconductor.
- Information (including circuit diagrams and circuit parameters) herein is for example only ; it is not guaranteed for volume production. MSKSEMI Semiconductor believes information herein is accurate and reliable, but no guarantees are made or implied regarding its use or any infringements of intellectual property rights or other rights of third parties.
- Any and all information described or contained herein are subject to change without notice due to product/technology improvement, etc. When designing equipment, refer to the "Delivery Specification" for the MSKSEMI Semiconductor product that you intend to use.