

# MSKSEMI

SEMICONDUCTOR



ESD



TVS



TSS



MOV



GDT



PLED

Product data sheet

## Features

- ◆ 300 Watts peak pulse power (tp = 8/20μs)
- ◆ Transient protection for high speed data lines to IEC 61000-4-2 (ESD) ±30kV (air), ±30kV (contact) IEC 61000-4-4 (EFT) 40A (5/50ns)
- ◆ Working voltages : 3V,5V,12V,15V,24V
- ◆ Protects two bidirectional line
- ◆ Low operating and clamping voltages
- ◆ Solid-state silicon avalanche technology

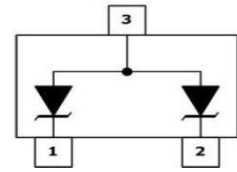

**SOT-23**

## Applications

- ◆ Notebooks, Desktops, Servers and Video Graphics Cards
- ◆ USB Power & Data Line Protection
- ◆ Monitors and Flat Panel Displays
- ◆ I<sup>2</sup>C Bus Protection
- ◆ Portable Instrumentation
- ◆ Set Top Box

## Maximum Rating @ Ta=25°C unless otherwise specified

| Symbol           | Parameter                      | Ratings     | Units |
|------------------|--------------------------------|-------------|-------|
| P <sub>PK</sub>  | Peak Pulse Power (tp = 8/20μs) | 300         | Watts |
| T <sub>L</sub>   | Lead Soldering Temperature     | 260(10sec.) | °C    |
| T <sub>J</sub>   | Operating Temperature          | -55 to +125 | °C    |
| T <sub>STG</sub> | Storage Temperature            | -55 to +150 | °C    |

## Electrical Characteristics @ Ta=25°C unless otherwise

| P/N           | V <sub>RWM</sub><br>(V)<br>(max.) | V <sub>B</sub><br>(V)<br>(min.) | I <sub>T</sub><br>(mA) | V <sub>C@1A</sub><br>(V)<br>(max.) | V <sub>C</sub><br>(V)<br>(max.) (@A) | I <sub>R</sub><br>(μA)<br>(max.) | C <sub>T</sub><br>(pF)<br>(max.) |
|---------------|-----------------------------------|---------------------------------|------------------------|------------------------------------|--------------------------------------|----------------------------------|----------------------------------|
| ESD3V3S2UT-MS | 3.3                               | 4                               | 1                      | 7.0                                | 14    20                             | 40                               | 450                              |
| ESD5V2S2UT-MS | 5                                 | 6                               | 1                      | 9.8                                | 18    17                             | 10                               | 300                              |
| ESD12VS2UT-MS | 12                                | 13.3                            | 1                      | 19                                 | 32    11                             | 1                                | 130                              |
| ESD15VS2UT-MS | 15                                | 16.7                            | 1                      | 24                                 | 38    10                             | 1                                | 120                              |
| ESD24VS2UT-MS | 24                                | 26.7                            | 1                      | 43                                 | 52    7                              | 1                                | 80                               |

Typical Characteristics @ Ta=25°C unless otherwise specified

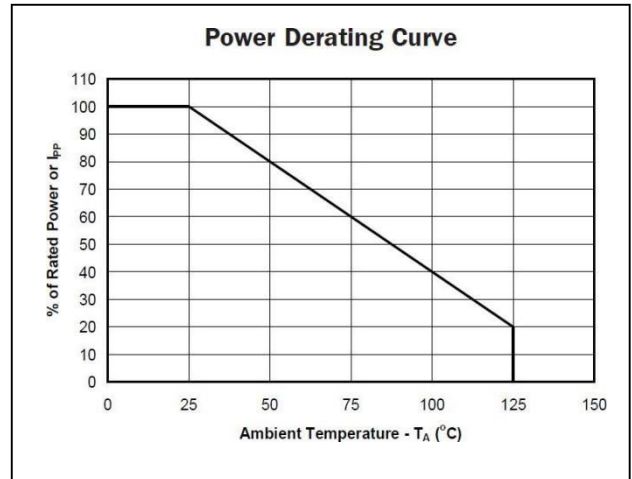
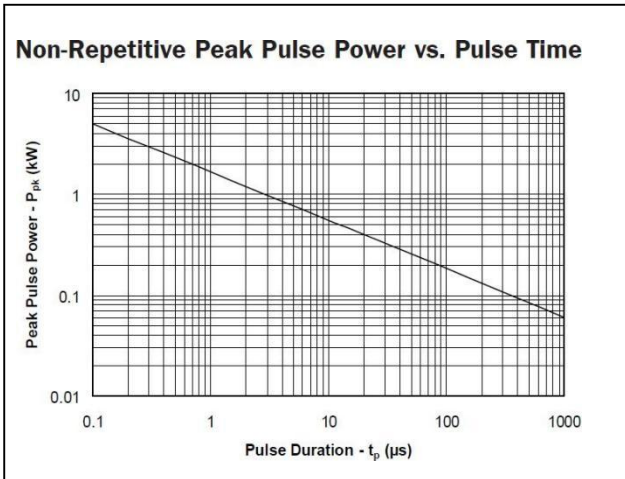
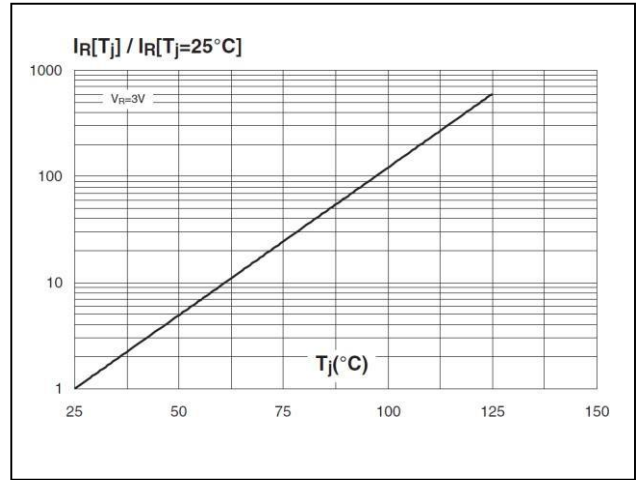
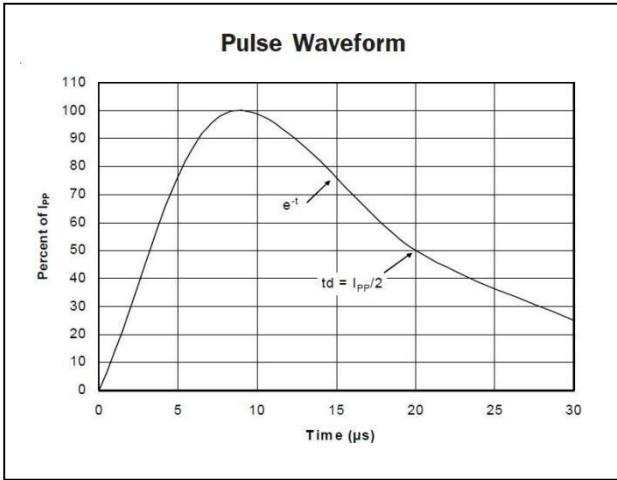

Soldering Parameters

|  |   |                         |
|--|---|-------------------------|
| <b>Reflow Condition</b>  |   | Fb – Free assembly      |
| <b>Pre Heat</b>  | - Temperature Min ( $T_{s(\text{Min})}$ ) | 150°C                   |
|  | - Temperature Max ( $T_{s(\text{Max})}$ ) | 200°C                   |
|  | - Time (Min to max) ( $t_s$ )             | 60 – 180 secs           |
| <b>Average ramp up rate (Liquidus) Temp (<math>T_L</math>) to peak</b>   |   | 3°C/second Max          |
| <b><math>T_{s(\text{Max})}</math> to <math>T_L</math> - Ramp-up Rate</b> |   | 3°C/second Max          |
| <b>Reflow</b>  | - Temperature ( $T_j$ ) (Liquidus)        | 217°C                   |
|  | - Temperature ( $t_j$ )                   | 60 – 150 seconds        |
| <b>Peak Temperature (<math>T_p</math>)</b>                               |   | 250 <sup>+0/-5</sup> °C |
| <b>Time within 5°C of actual peak Temperature (<math>t_p</math>)</b>     |   | 20 – 40 seconds         |
| <b>Ramp-down Rate</b>  |   | 6°C/second Max          |
| <b>Time 25°C to peak Temperature (<math>T_p</math>)</b>                  |   | 8 minutes Max.          |
| <b>Do not exceed</b>   |   | 260°C                   |

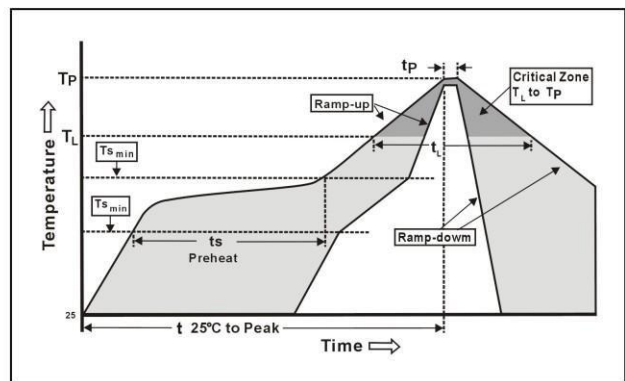

**PACKAGE MECHANICAL DATA**

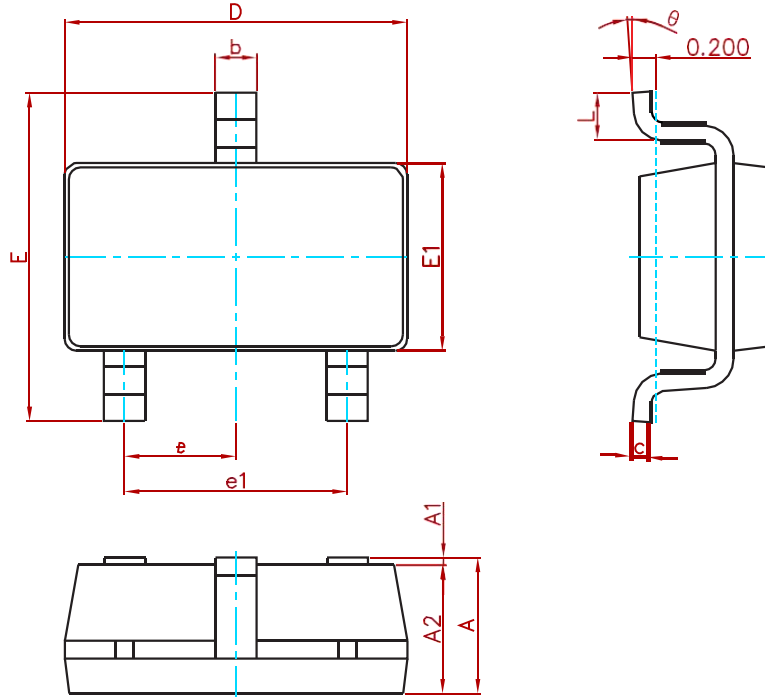

| Symbol | Dimensions In Millimeters |       | Dimensions In Inches |       |
|--------|---------------------------|-------|----------------------|-------|
|        | Min.                      | Max.  | Min.                 | Max.  |
| A      | 1.050                     | 1.250 | 0.041                | 0.049 |
| A1     | 0.000                     | 0.100 | 0.000                | 0.004 |
| A2     | 1.050                     | 1.150 | 0.041                | 0.045 |
| b      | 0.300                     | 0.500 | 0.012                | 0.020 |
| c      | 0.100                     | 0.200 | 0.004                | 0.008 |
| D      | 2.820                     | 3.020 | 0.111                | 0.119 |
| E1     | 1.500                     | 1.700 | 0.059                | 0.067 |
| E      | 2.650                     | 2.950 | 0.104                | 0.116 |
| e      | 0.950(BSC)                |       | 0.037(BSC)           |       |
| e1     | 1.800                     | 2.000 | 0.071                | 0.079 |
| L      | 0.300                     | 0.600 | 0.012                | 0.024 |
| 0      | 0°                        | 8°    | 0°                   | 8°    |

**Suggested Pad Layout**

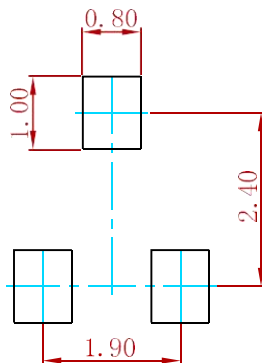

Note:  
 1. Controlling dimension: in millimeters.  
 2. General tolerance: ± 0.05mm.  
 3. The pad layout is for reference purposes only.

**REEL SPECIFICATION**

| P/N           | PKG    | QTY  |
|---------------|--------|------|
| ESDXXXS2UT-MS | SOT-23 | 3000 |

## **Attention**

- Any and all MSKSEMI Semiconductor products described or contained herein do not have specifications that can handle applications that require extremely high levels of reliability, such as life-support systems, aircraft's control systems, or other applications whose failure can be reasonably expected to result in serious physical and/or material damage. Consult with your MSKSEMI Semiconductor representative nearest you before using any MSKSEMI Semiconductor products described or contained herein in such applications.
- MSKSEMI Semiconductor assumes no responsibility for equipment failures that result from using products at values that exceed, even momentarily, rated values (such as maximum ratings, operating condition ranges, or other parameters) listed in products specifications of any and all MSKSEMI Semiconductor products described or contained herein.
- Specifications of any and all MSKSEMI Semiconductor products described or contained herein stipulate the performance, characteristics, and functions of the described products in the independent state, and are not guarantees of the performance, characteristics, and functions of the described products as mounted in the customer's products or equipment. To verify symptoms and states that cannot be evaluated in an independent device, the customer should always evaluate and test devices mounted in the customer's products or equipment.
- MSKSEMI Semiconductor strives to supply high-quality high-reliability products. However, any and all semiconductor products fail with some probability. It is possible that these probabilistic failures could give rise to accidents or events that could endanger human lives, that could give rise to smoke or fire, or that could cause damage to other property. When designing equipment, adopt safety measures so that these kinds of accidents or events cannot occur. Such measures include but are not limited to protective circuits and error prevention circuits for safe design, redundant design, and structural design.
- In the event that any or all MSKSEMI Semiconductor products (including technical data, services) described or contained herein are controlled under any of applicable local export control laws and regulations, such products must not be exported without obtaining the export license from the authorities concerned in accordance with the above law.
- No part of this publication may be reproduced or transmitted in any form or by any means, electronic or mechanical, including photocopying and recording, or any information storage or retrieval system, or otherwise, without the prior written permission of MSKSEMI Semiconductor.
- Information (including circuit diagrams and circuit parameters) herein is for example only ; it is not guaranteed for volume production. MSKSEMI Semiconductor believes information herein is accurate and reliable, but no guarantees are made or implied regarding its use or any infringements of intellectual property rights or other rights of third parties.
- Any and all information described or contained herein are subject to change without notice due to product/technology improvement, etc. When designing equipment, refer to the "Delivery Specification" for the MSKSEMI Semiconductor product that you intend to use.