

RoHS

SPECIFICATIONS

Rated Current:1.5AMP
 Contact Resistance:20mΩ Max
 Withstand Voltage:400V AC/DC
 Insulation Resistance:800MΩ Min
 Operation Temperature:-40°C to +105°C

Contact Material:Brass
 Contact Plating:Au Over Ni
 Insulator Material:Polyester(UL94V-0)
 Standard: PA6T
 Max.Processing Temp: 230°C for 30-60 seconds
 (260°C for 10 seconds)

Recommended P.C.B Layout(Top Side)
 (PCB BOARD TOLERANCE±0.05)

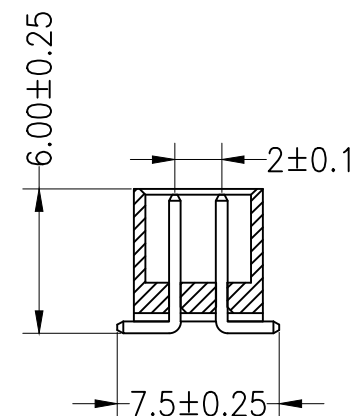
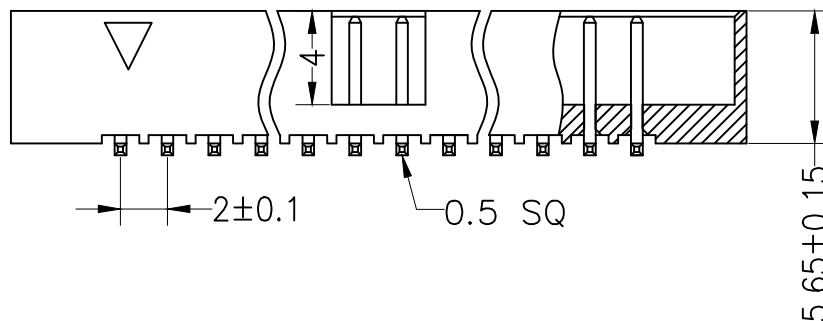
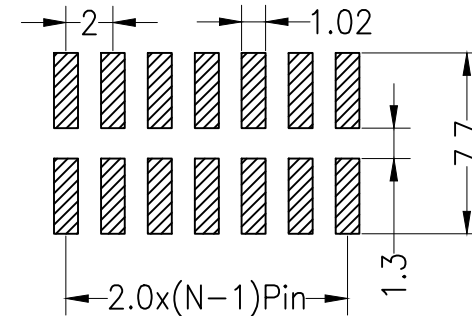
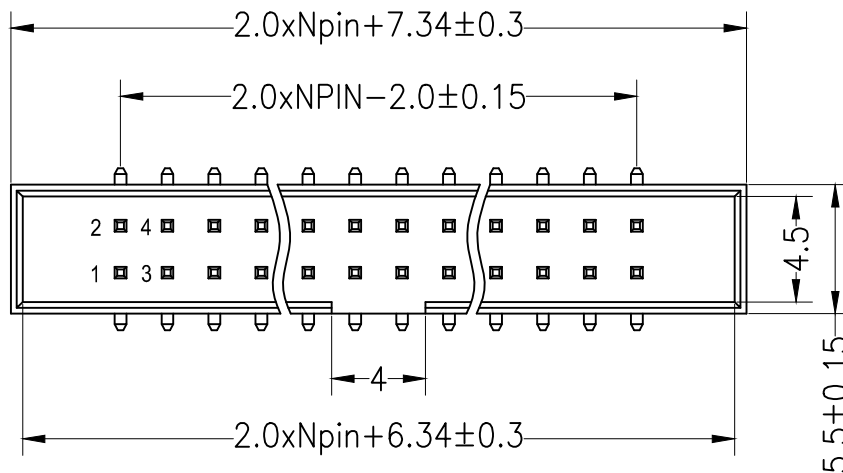

				OPERATION		DRAW		SCALE	FIT	深圳市连盛精密连接器有限公司	
				X.X	±0.30			UNIT	mm		
				X.XX	±0.20	CHECK		SIZE	A4	PART NO. BH-00311	
				X.XXX	±0.10	APPROVE		SHEET	1/1	TITLE: 2.0Box Npin H5.65 SMT	
REV	DATE	MODIFICATION DESCRIPTION	CHANGE	DIM	TOL			PROJ.			