



1500 Watt Low Clamping Transient Voltage Suppressor

Screening in reference to MIL-PRF-19500 available

DESCRIPTION

The ICT-10 through ICT-45C series of Transient Voltage Suppressors (TVSs) are designed for the protection of integrated circuits that require very low Clamping Voltages (V_C) during a transient threat. Due to their very fast response time, protection level and high Peak Pulse Power (P_{PP}) capability, they are extremely effective in providing protection against line transients generated by: voltage reversals, capacitive or inductive load switching, electromechanical switching, electrostatic discharge and electromagnetic coupling.

Important: For the latest information, visit our website <http://www.microsemi.com>.

FEATURES

- This series of TVS devices is designed to protect Bipolar, MOS and Schottky improved integrated circuits.
- Transient protection for CMOS, MOS, Bipolar, ICS (TTL, ECL, DTL, RTL and linear functions)
- 10 to 45 volts
- Low clamping ratio
- Hermetic sealed DO-13 metal package
- RoHS compliant versions available

APPLICATIONS / BENEFITS

- These TVSs are designed for the protection of integrated circuits. Characterized by a very low clamping voltage together with a low standoff voltage, they afford a high degree of protection to: TTL, ECL, DTL, MOS, CMOS, VMOS, HMOS, NMOS and static memory circuits

MAXIMUM RATINGS @ $T_A = 25^\circ\text{C}$ unless otherwise noted.

Parameters/Test Conditions	Symbol	Value	Unit
Junction and Storage Temperature	T_J and T_{STG}	-65 to +175	$^\circ\text{C}$
Peak Pulse Power @ 25°C (10x1000 μs)	P_{PP}	1500	W
Rated Forward Surge Current 1/120 second @ 25°C ⁽¹⁾	I_{FSM}	200	A
Rated Average Power Dissipation	$P_{M(AV)}$	1.0	W
$t_{clamping}$ (0 volts to $V_{(BR)}$ min) ps theoretical for:			
unidirectional		<100	ns
bidirectional		<5	
Clamping Factor ⁽²⁾ :			
@ Full rated power		1.33	
@ 50% rated power		1.20	
Impulse Repetition Rate	df	0.01	%
Solder Temperature @ 10 s		260	$^\circ\text{C}$

- Notes:**
1. Applies to unidirectional or single direction only.
 2. The ratio of the actual V_C (clamping voltage) to the actual $V_{(BR)}$ (breakdown voltage as measured on a specific device).

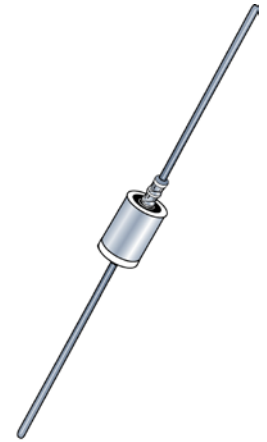

DO-202AA (DO-13) Package

Also available in:

Case 1 package
(plastic equivalent)
 [LCE6.5 – LCE170A](#)

MSC – Lawrence
6 Lake Street,
Lawrence, MA 01841
Tel: 1-800-446-1158 or
(978) 620-2600
Fax: (978) 689-0803

MSC – Ireland
Gort Road Business Park,
Ennis, Co. Clare, Ireland
Tel: +353 (0) 65 6840044
Fax: +353 (0) 65 6822298

Website:
www.microsemi.com

MECHANICAL and PACKAGING

- CASE: DO-13 welded, hermetically sealed metal and glass
- FINISH: Tin-lead or RoHS Compliant matte-tin plating solderable per MIL-STD-750, method 2026
- POLARITY: Cathode connected to case and marked. Bidirectional not marked.
- WEIGHT: Approximately 1.4 grams
- MOUNTING POSITION: Any
- See [Package Dimensions](#) on last page.

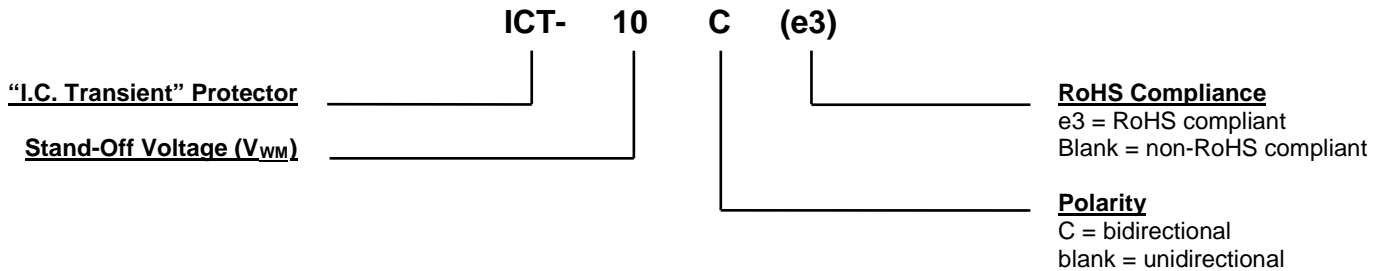
PART NOMENCLATURE

SYMBOLS & DEFINITIONS

Symbol	Definition
I_D	Standby Current: The current through the device at rated stand-off voltage.
I_{FSM}	Surge Peak Forward Current: The forward current including all nonrepetitive transient currents but excluding all repetitive transients (ref JESD282-B)
I_{PP}	Peak Impulse Current: The maximum rated random recurring peak impulse current or nonrepetitive peak impulse current that may be applied to a device. A random recurring or nonrepetitive transient current is usually due to an external cause, and it is assumed that its effect will have completely disappeared before the next transient arrives.
P_{PP}	Peak Pulse Power. The rated random recurring peak impulse power or rated nonrepetitive peak impulse power. The impulse power is the maximum-rated value of the product of I_{PP} and V_C .
$V_{(BR)}$	Breakdown Voltage: The voltage across the device at a specified current $I_{(BR)}$ in the breakdown region.
V_{WM}	Working Standoff Voltage: The maximum-rated value of dc or repetitive peak positive cathode-to-anode voltage that may be continuously applied over the standard operating temperature.
V_C	Clamping Voltage: The voltage across the device in a region of low differential resistance during the application of an impulse current (I_{PP}) for a specified waveform.

ELECTRICAL CHARACTERISTICS @ 25 °C

PART NUMBER	STAND-OFF VOLTAGE (NOTE 1) V_{WM}	MAXIMUM REVERSE LEAKAGE @ V_{WM} I_D	MINIMUM* BREAKDOWN VOLTAGE @ 1 mA $V_{(BR)}$ (min)	MAXIMUM CLAMPING VOLTAGE (Fig. 1) $I_{PP1} = 1A$ V_C	MAXIMUM CLAMPING VOLTAGE (Fig. 1) @ $I_{PP2} = 10A$ V_C	MAXIMUM PEAK PULSE CURRENT @ 10 X 1000 μs I_{PP3}
	VOLTS	μA	VOLTS	VOLTS	VOLTS	A
ICT-10	10.0	2	11.7	13.7	14.1	90
ICT-12	12.0	2	14.1	16.1	16.5	70
ICT-15	15.0	2	17.6	20.1	20.6	60
ICT-18	18.0	2	21.2	24.2	25.2	50
ICT-22	22.0	2	25.9	29.8	32.0	40
ICT-36	36.0	2	42.4	50.6	54.3	23
ICT-45	45.0	2	52.9	63.3	70.0	19

V_F at 100 amps peak, 8.3 ms sine wave equals 3.5 volts maximum.

ICT-10C	10.0	2	11.7	14.1	14.5	90
ICT-12C	12.0	2	14.1	16.7	17.1	70
ICT-15C	15.0	2	17.6	20.8	21.4	60
ICT-18C	18.0	2	21.2	24.8	25.5	50
ICT-22C	22.0	2	25.9	30.8	32.0	40
ICT-36C	36.0	2	42.4	50.6	54.3	23
ICT-45C	45.0	2	52.9	63.3	70.0	19

C suffix indicates Bidirectional.

NOTE 1: TVSs are normally selected according to the reverse “Stand Off Voltage” V_{WM} which should be equal to or greater than the dc or repetitive peak operation voltage level.

* The minimum breakdown voltage as shown takes into consideration the +/-1 volt tolerance normally specified for power supply regulation on most integrated circuit manufacturers data sheets. Similar devices are available with reduced clamping voltages where tighter regulated power supply voltages are employed.

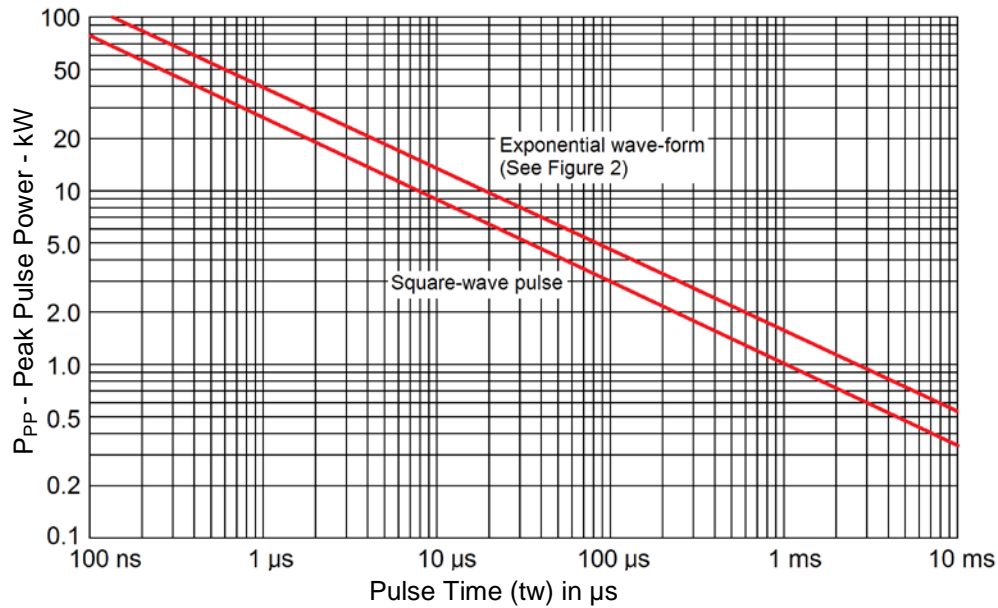
GRAPHS

FIGURE 1

Non-Repetitive Peak Pulse Power Rating Curve

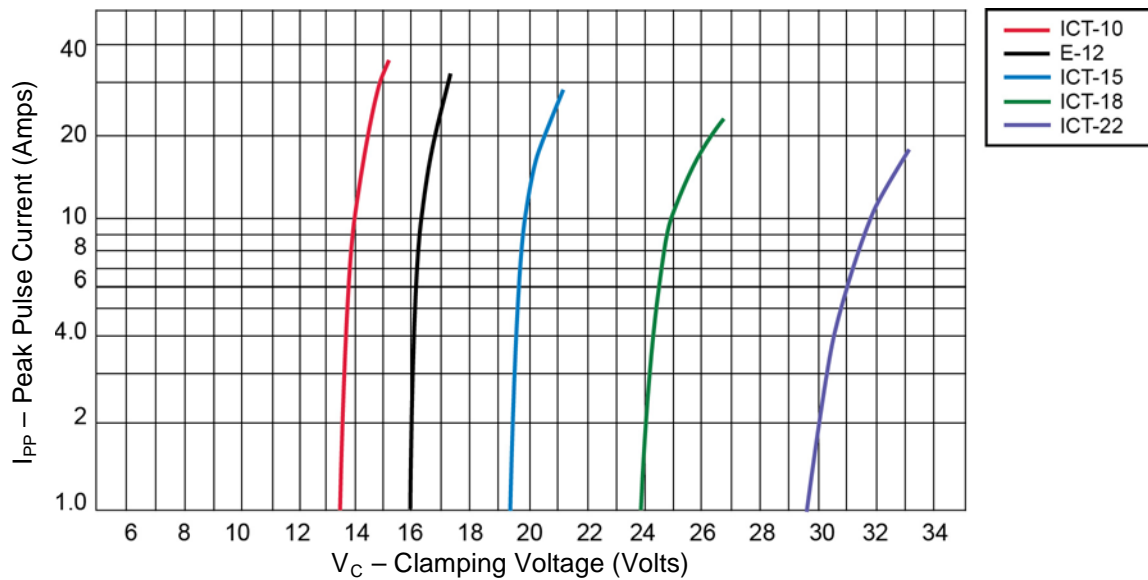
NOTE: Peak power defined as peak voltage times peak current.

FIGURE 2

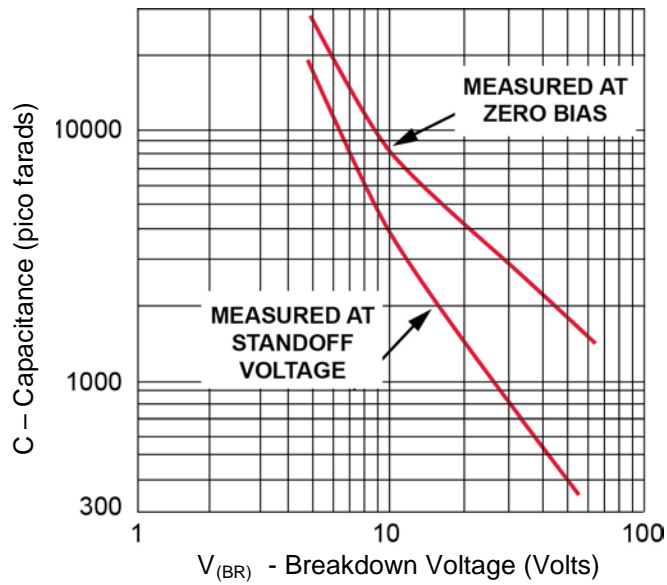
Typical Characteristic Clamping Voltage vs. Peak Pulse Current

GRAPHS (continued)

FIGURE 3

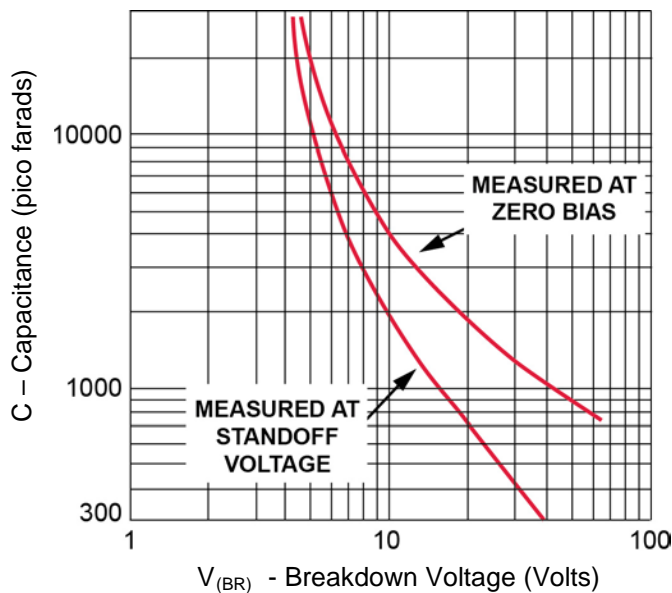
Typical Capacitance vs. Breakdown Voltage (Unidirectional Types)

FIGURE 4

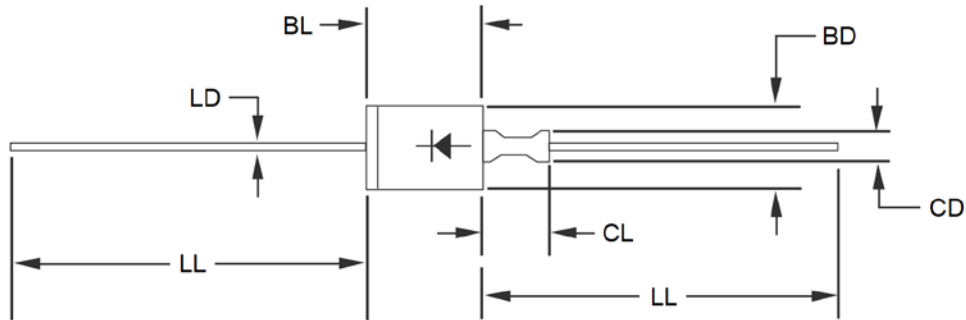
Typical Capacitance vs. Breakdown Voltage (Bidirectional Types)

PACKAGE DIMENSIONS

NOTES:

- 1 Dimensions are in inches.
- 2 Millimeter equivalents are given for information only.
- 3 The major diameter is essentially constant along its length.
- 4 Dimension to allow for pinch or seal deformation anywhere along tubulation.
- 5 Symbol for bidirectional transient suppressor.
- 6 Lead 1 is electrically connected to the case.
- 7 In accordance with ASME Y14.5M, diameters are equivalent to Φ x symbology.

Symbol	Dimensions				Notes
	Inches		Millimeters		
	Min	Max	Min	Max	
BD	0.215	0.235	5.46	5.97	
BL	0.315	0.350	8.00	8.90	3
CD	0.045	0.100	1.14	2.54	4
CL	-	0.210	-	5.33	
LD	0.026	0.035	0.660	0.889	
LL	1.000	1.625	25.40	41.28	