



Voidless Hermetically Sealed Bidirectional Transient Voltage Suppressors

Qualified to MIL-PRF-19500/516

*Qualified Levels:
JAN, JANTX, JANTXV
and JANS*

DESCRIPTION

This series of industry recognized voidless, hermetically sealed bidirectional Transient Voltage Suppressors (TVS) are military qualified to MIL-PRF-19500/516 and are ideal for high-reliability applications where a failure cannot be tolerated. They provide a working peak “standoff” voltage selection from 5.2 to 152 Volts with a 1500 W rating for a 10/1000 μ s pulse. They are very robust in hard-glass construction and use internal Category 1 metallurgical bonds for high reliability. These devices are available as both a non-suffix part and an “A” version part involving different voltage tolerances as described in the [nomenclature](#) section. These devices are also available in a surface mount MELF package configuration.

Important: For the latest information, visit our website <http://www.microsemi.com>.

FEATURES

- High surge current and peak pulse power provides transient voltage protection for sensitive circuits
- Triple-layer passivation
- Internal “Category 1” metallurgical bonds
- Voidless hermetically sealed glass package
- JAN, JANTX, JANTXV and JANS qualified versions are available per MIL-PRF-19500/516. (See [part nomenclature](#) for all available options.)
- RoHS compliant versions available (commercial grade only)

APPLICATIONS / BENEFITS

- Military and other high-reliability applications
- Extremely robust construction
- Extensive range in working peak “standoff” voltage (V_{WM}) from 5.2 to 152 volts
- 1500 watt peak pulse power (P_{PP}) for a 10/1000 μ s test pulse
- ESD and EFT protection per IEC6100-4-2 and IEC61000-4-4 respectively
- Protection from the secondary effects of lightning per select levels in IEC61000-4-5.
- Flexible axial-leaded mounting terminals
- Non-sensitive to ESD per MIL-STD-750 method 1020
- Inherently radiation hard as described in Microsemi “[MicroNote 050](#)”

MAXIMUM RATINGS @ $T_A = 25^\circ\text{C}$ unless otherwise noted.

Parameters/Test Conditions	Symbol	Value	Unit
Junction and Storage Temperature	T_J and T_{STG}	-55 to +175	$^\circ\text{C}$
Thermal Resistance Junction-to-Lead ⁽¹⁾	$R_{\theta JL}$	20	$^\circ\text{C/W}$
Peak Pulse Power @ 25°C	P_{PP}	1500	W
Off-State Power @ $T_L = 75^\circ\text{C}$ ⁽¹⁾	P_D	5.0	W
Off-State Power @ $T_A = 25^\circ\text{C}$ ⁽²⁾	P_D	3.0	W
Impulse Repetition Rate	df	0.01	%
Solder Temperature @ 10 s	T_{SP}	260	$^\circ\text{C}$

- Notes:**
- At 3/8 inch lead length from body (see [figure 4](#)).
 - Steady-state power ratings with reference to ambient are for PC boards where thermal resistance from mounting point to ambient is sufficiently controlled where T_{OP} or $T_{J(MAX)}$ is not exceeded (also see [figure 6](#)).

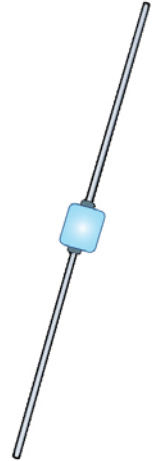

“C” Package

Also available in:

**“C” SQ-MELF
Package**
(surface mount)

 [1N6138US – 1N6173US](#)

MSC – Lawrence

6 Lake Street,
Lawrence, MA 01841
Tel: 1-800-446-1158 or
(978) 620-2600
Fax: (978) 689-0803

MSC – Ireland

Gort Road Business Park,
Ennis, Co. Clare, Ireland
Tel: +353 (0) 65 6840044
Fax: +353 (0) 65 6822298

Website:

www.microsemi.com

MECHANICAL and PACKAGING

- CASE: Hermetically sealed voidless hard glass with tungsten slugs
- TERMINALS: Axial-leads are tin/lead over copper. RoHS compliant matte-tin is available on commercial grade only.
- MARKING: Body paint and part number
- POLARITY: No polarity marking for these bidirectional TVSs
- TAPE & REEL option: Standard per EIA-296. Consult factory for quantities.
- WEIGHT: Approximately 1270 milligrams
- See [package dimensions](#) on last page.

PART NOMENCLATURE

JAN 1N6138 A e3

Reliability Level

JAN = JAN Level
 JANTX = JANTX Level
 JANTXV = JANTXV Level
 JANS = JANS Level
 Blank = commercial

JEDEC type number

See [Electrical Characteristics](#) table

RoHS Compliance

e3 = RoHS compliant (available on commercial grade only)
 Blank = non-RoHS compliant

Voltage Tolerance

A = Standard
 Blank = 5% higher V_C , 5% lower min. $V_{(BR)}$ and 5% lower I_{PP}

SYMBOLS & DEFINITIONS

Symbol	Definition
$\alpha_{V(BR)}$	Temperature Coefficient of Breakdown Voltage: The change in breakdown voltage divided by the change in temperature that caused it expressed in %/°C or mV/°C.
$V_{(BR)}$	Breakdown Voltage: The voltage across the device at a specified current $I_{(BR)}$ in the breakdown region.
V_{WM}	Working Standoff Voltage: The maximum-rated value of dc or repetitive peak positive cathode-to-anode voltage that may be continuously applied over the standard operating temperature.
I_D	Standby Current: The current through the device at rated stand-off voltage.
V_C	Clamping Voltage: The voltage across the device in a region of low differential resistance during the application of an impulse current (I_{PP}) for a specified waveform.
P_{PP}	Peak Pulse Power. The rated random recurring peak impulse power or rated nonrepetitive peak impulse power. The impulse power is the maximum-rated value of the product of I_{PP} and V_C .

ELECTRICAL CHARACTERISTICS

INDUSTRY TYPE NUMBER (Note 1)	MINIMUM BREAKDOWN VOLTAGE (Note 1)		RATED STANDOFF VOLTAGE	MAXIMUM STANDBY CURRENT	MAXIMUM CLAMPING VOLTAGE (Note 1)	MAXIMUM PEAK PULSE CURRENT (Note 1)	MAXIMUM TEMP. COEF. OF $V_{(BR)}$ $\alpha_{V(BR)}$
	$V_{(BR)}$	@ $I_{(BR)}$					
	Volts	mA	V	I_D @ V_{WM}	V_C @ I_{PP}	Amps	%/°C
1N6138A	6.46	175	5.2	500	10.5	142.8	0.05
1N6139A	7.13	175	5.7	300	11.2	133.9	.06
1N6140A	7.79	150	6.2	100	12.1	124.0	.06
1N6141A	8.65	150	6.9	100	13.4	111.9	.06
1N6142A	9.50	125	7.6	100	14.5	103.4	.07
1N6143A	10.45	125	8.4	20	15.6	96.2	.07
1N6144A	11.40	100	9.1	20	16.9	88.8	.07
1N6145A	12.35	100	9.9	20	18.2	82.4	.08
1N6146A	14.25	75	11.4	20	21.0	71.4	.08
1N6147A	15.20	75	12.2	20	22.3	67.3	.08
1N6148A	17.10	65	13.7	10	25.1	59.8	.085
1N6149A	19.0	65	15.2	5	27.7	54.2	.085
1N6150A	20.9	50	16.7	5	30.5	49.2	.085
1N6151A	22.8	50	18.2	5	33.3	45.0	.09
1N6152A	25.7	50	20.6	5	37.4	40.1	.09
1N6153A	28.5	40	22.8	5	41.6	36.0	.09
1N6154A	31.4	40	25.1	5	45.7	32.8	.095
1N6155A	34.2	30	27.4	5	49.9	30.1	.095
1N6156A	37.1	30	29.7	5	53.6	28.0	.095
1N6157A	40.9	30	32.7	5	59.1	25.4	.095
1N6158A	44.7	25	35.8	5	64.6	23.2	.095
1N6159A	48.5	25	38.8	5	70.1	21.4	.095
1N6160A	53.2	20	42.6	5	77.0	19.5	.095
1N6161A	58.9	20	47.1	5	85.3	17.6	.100
1N6162A	64.6	20	51.7	5	97.1	15.4	.100
1N6163A	71.3	20	56.0	5	103.1	14.5	.100
1N6164A	77.9	15	62.2	5	112.8	13.3	.100
1N6165A	86.5	15	69.2	5	125.1	12.0	.100
1N6166A	95.0	12	76.0	5	137.6	10.9	.100
1N6167A	104.5	12	86.6	5	151.3	9.9	.100
1N6168A	114.0	10	91.2	5	165.1	9.1	.100
1N6169A	123.5	10	98.8	5	178.8	8.4	.105
1N6170A	142.5	8	114.0	5	206.3	7.3	.105
1N6171A	152.0	8	121.6	5	218.4	6.9	.105
1N6172A	171.0	5	136.8	5	245.7	6.1	.110
1N6173A	190.0	5	152.0	5	273.0	5.5	.110

Notes: 1. Part number without the A suffix has 5% higher V_C , 5% lower minimum $V_{(BR)}$, and 5% lower I_{PP} .

GRAPHS

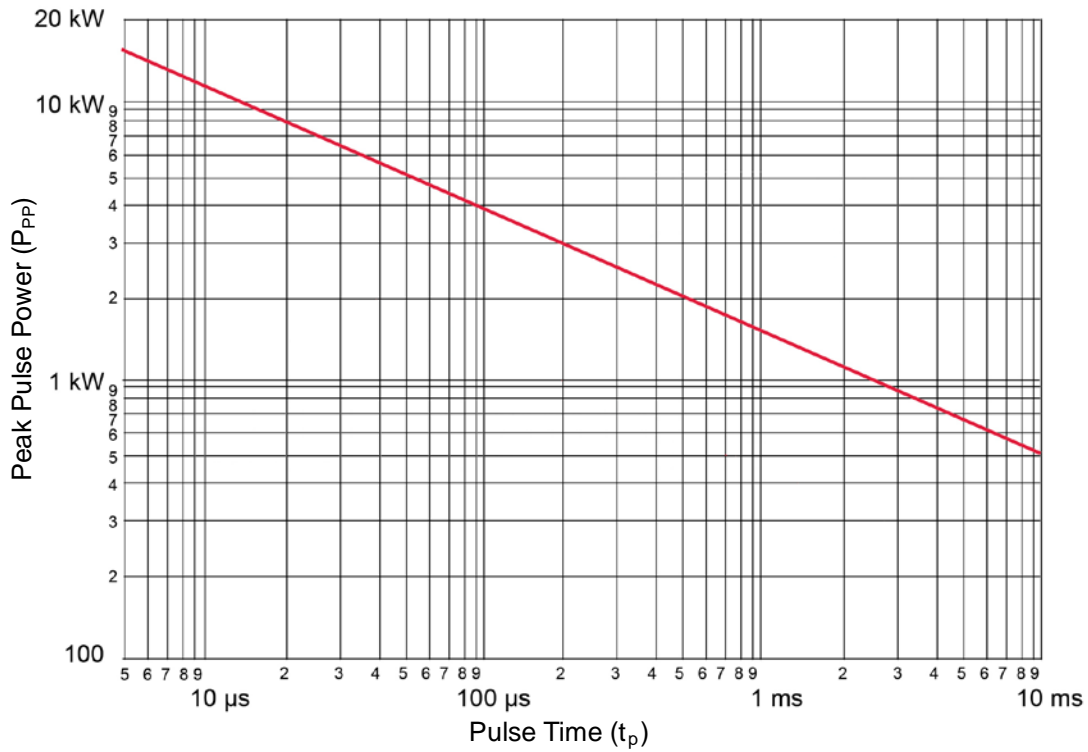

FIGURE 1
Peak Pulse Power vs. Pulse Time

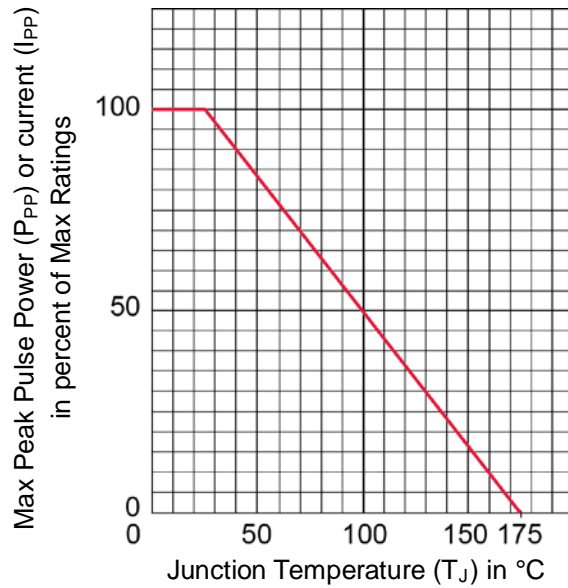

FIGURE 2
Peak Pulse Power vs T_J (prior to impulse)

GRAPHS

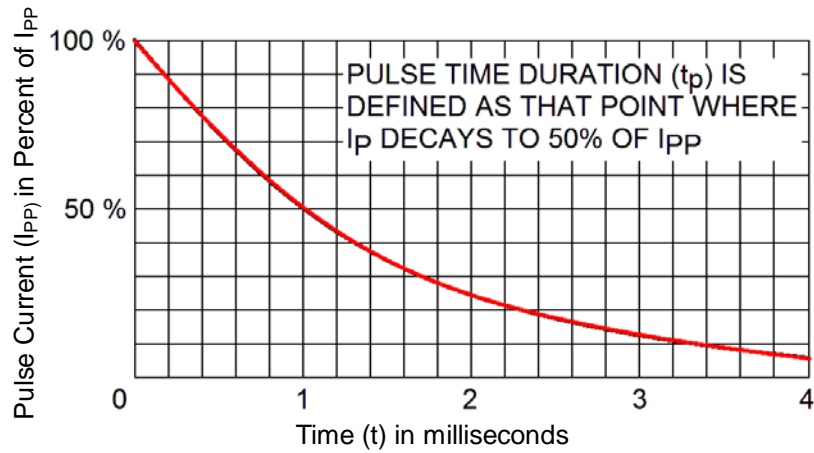

FIGURE 3
Pulse Wave Form

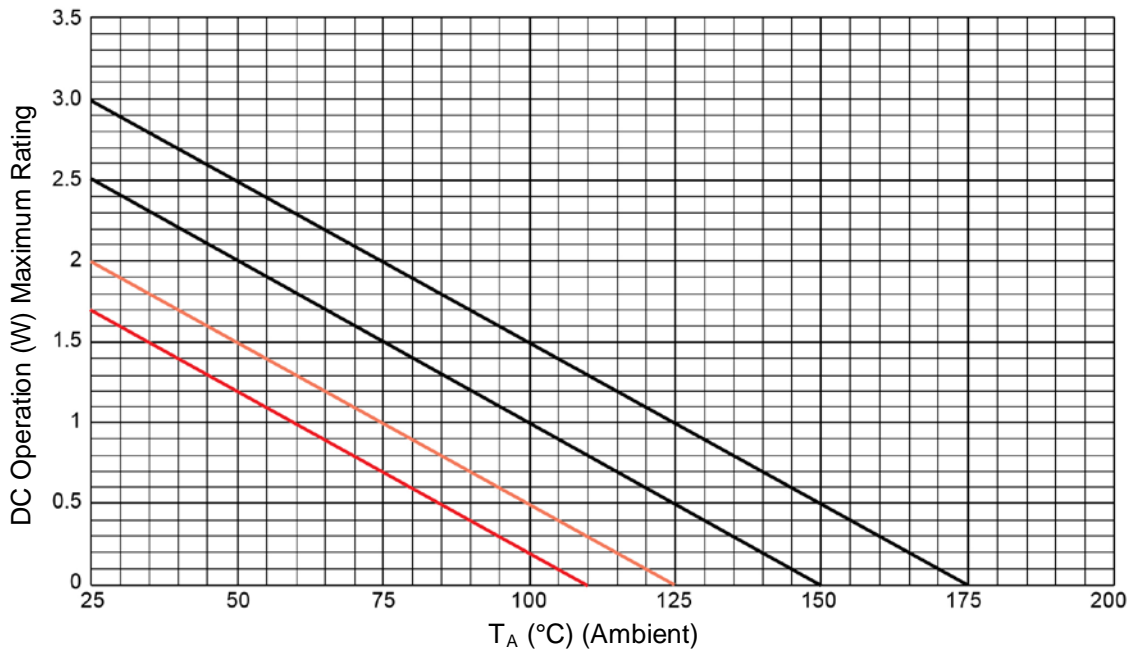

FIGURE 4
Temperature-Power Derating Curve

GRAPHS

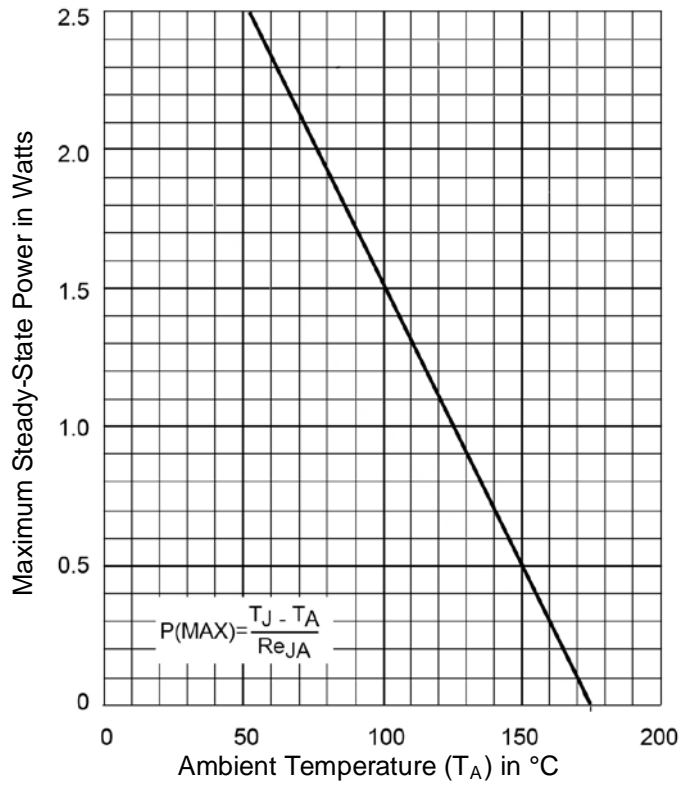
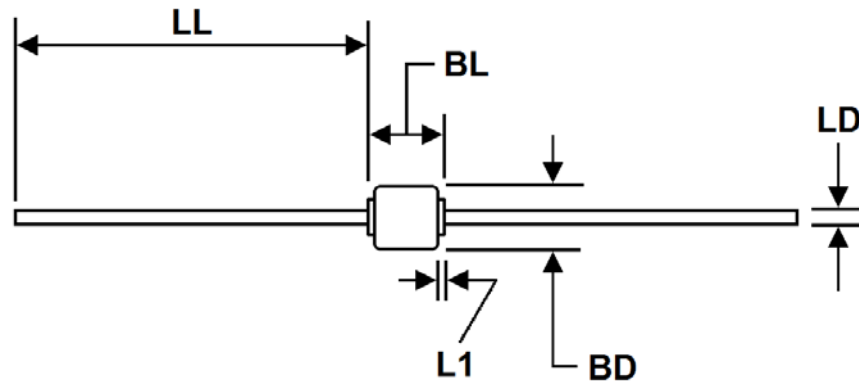
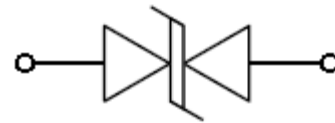

FIGURE 5
Steady-State Derating Curve for Free-Air Mounting (R_{θJA} = 50 °C/W)

PACKAGE DIMENSIONS

Ltr	Dimensions				Notes
	Inches		Millimeters		
	Min	Max	Min	Max	
BD	0.135	0.185	3.43	4.70	3
BL	0.140	0.195	3.56	4.95	
LD	0.036	0.042	0.91	1.07	
LL	1.00	1.30	25.4	33.02	
L1	-	0.030	-	0.76	4



Schematic Symbol

NOTES:

1. Dimensions are in inches.
2. Millimeters are given for general information only.
3. Dimension BD shall be measured at the largest diameter.
4. Dimension L1 lead diameter uncontrolled in this area.
5. In accordance with ASME Y14.5M, diameters are equivalent to Φ x symbology.